

PVC PARTITIONS



PVC OPTIONS

COLORS: BLACK and WHITE
STANDARD THICKNESSES: 1/4", 3/8", and 1/2" (1/4" Suspended Only)
OPTIONAL THICKNESSES: 1" and 1-1/2" (4 Unit MOQ on all thicknesses)
OVERALL DIMENSION:
WITH STAND: 22-1/2"x48-3/4"x72"x86-1/2"
WITHOUT STAND: 48"x84"
MAXIMUM STAND LOAD: 120lbs. / 54.43kgs.
PAINT GRADE: YES



FULLER Architectural Panels

Enhancing Millwork Packages

POLYCARBONATE PARTITIONS



FREE STANDING
(CLEAR POLYCARBONATE)



SUSPENDED

(BRONZE POLYCARBONATE)

POLYCARBONATE OPTIONS

COLORS: Clear, Ice and Bronze
STANDARD THICKNESSES: 3/8" (10mil)
OPTIONAL THICKNESSES: 6mil, 8mil and 16mil (MOQ Required)
OVERALL DIMENSION: WITH STAND: 22-1/2"x48-3/4"x86-1/2"
WITHOUT STAND: 3/8"x48"x84"
ADDITIONAL: Panels include a perimeter U-Channel

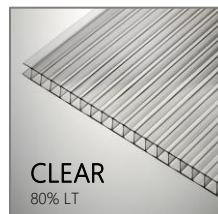

STAND DIMENSIONS

SIDE VIEW

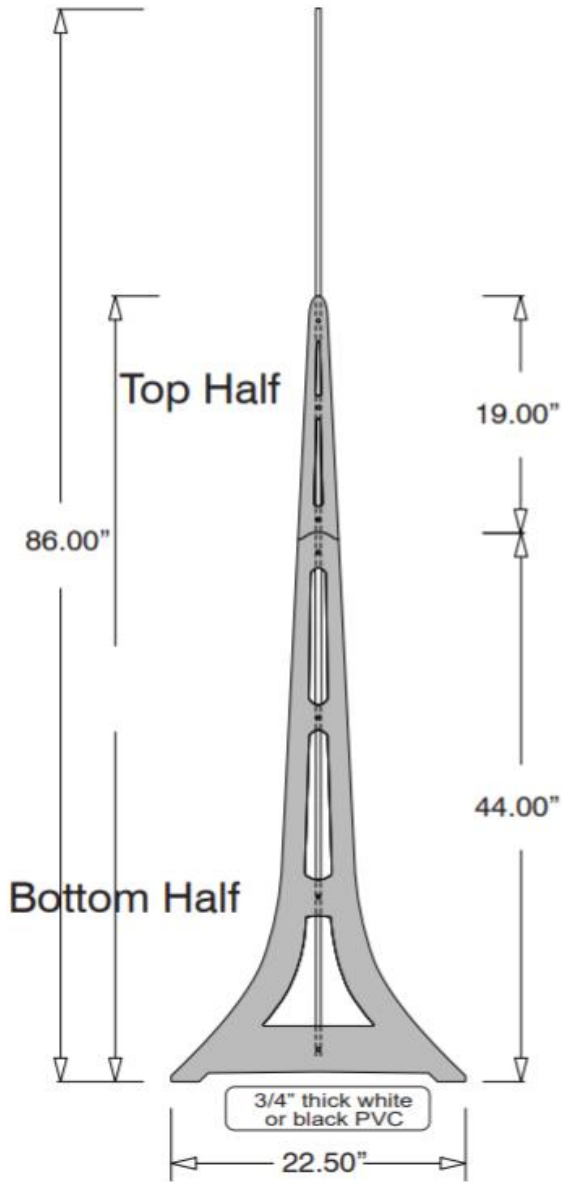

FRONT VIEW

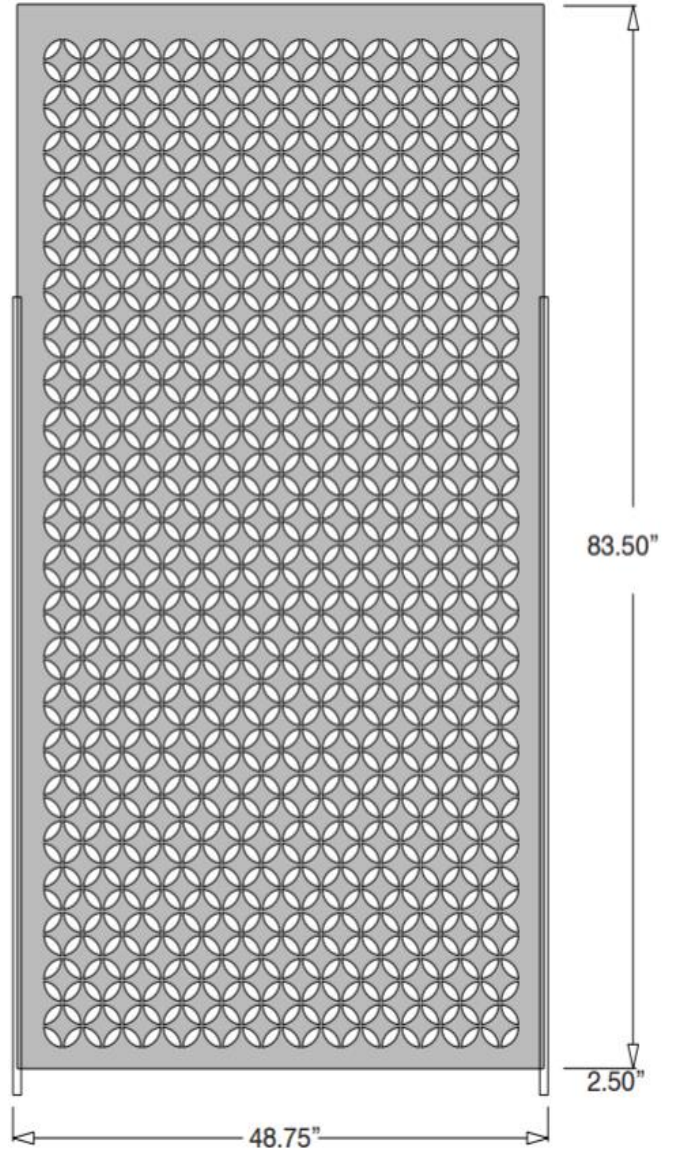

Optional Designer Panel Shown

Top View

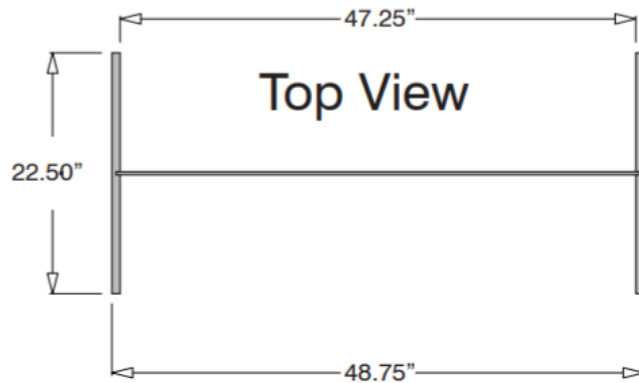

Stand and panel drawn to scale
 (7) Included Screws Per Side
 2 Piece Stand Weight 12lbs / 5.44kgs

SUSPENSION KIT SOLUTIONS

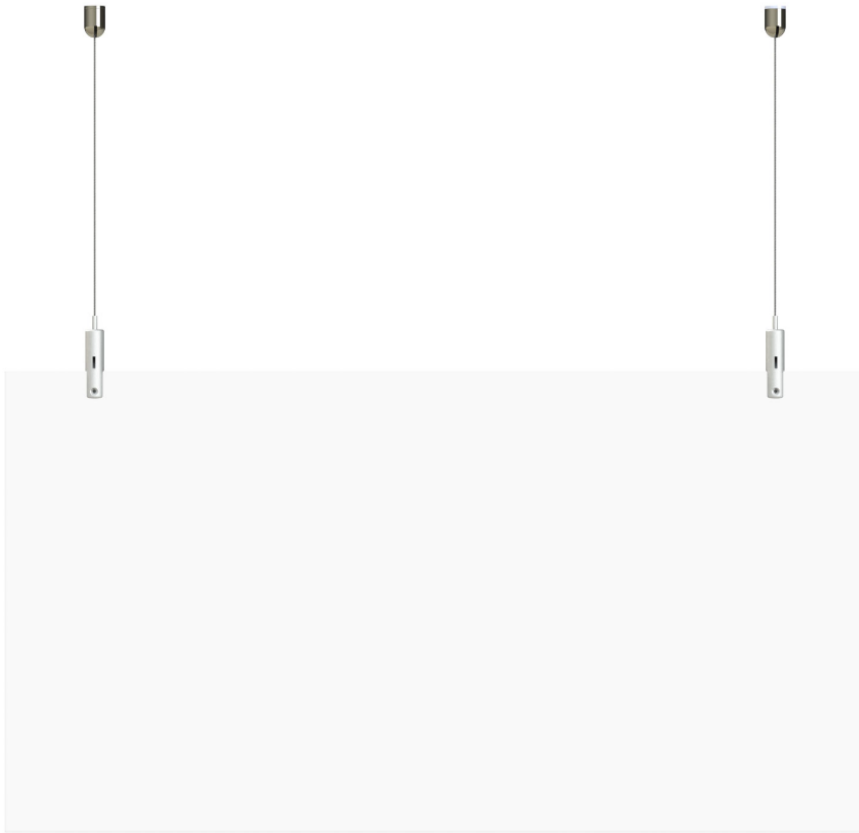

FIXED POINT SUSPENSION

Description: This kit is used for attaching to a solid ceiling whether the ceiling is flat or sloped.

Includes:

- (2) x 1/16"x60" stainless steel aircraft cables with barrel end
- (2) Sloped Ceiling Couplers
- (2) Top Clamp Cable Grippers

Fixed Point Kit SKU: FP-SLTC60

Panel Thickness: 1/4"

ADD SKU: FP-DG25ZTC500SAT (2 Larger Grippers)

Panel Thickness: 3/8" and 1/2"

Additional

Each kit is supplied with two suspension points which provides an overall safe working load of 120lbs.

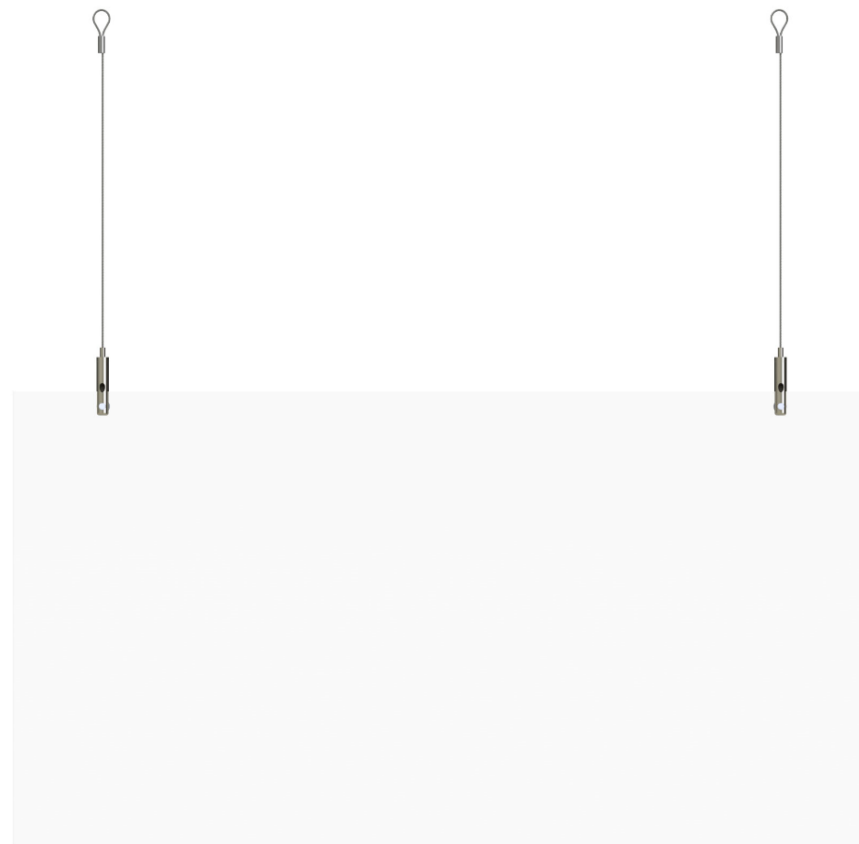

LOOPED CABLE SUSPENSION

Description: This kit is used for attaching to structure, beams or trusses.

Includes:

- (2) Top Clamp Cable Grippers
- (2) x 1/16"x60" stainless steel aircraft cables with looped ends

Looped Kit SKU: FP-44TC60

Panel Thickness: 1/4"

ADD SKU: FP-DG25ZTC500SAT (2 Large Grippers)

Panel Thickness: 3/8" and 1/2"

Additional

Each kit is supplied with two suspension points which provides an overall safe working load of 120lbs.

SUSPENSION KIT SOLUTIONS (cont.)



T-BAR DROPPED CEILING SUSPENSION

Description: Kit used for attaching to a T-bar ceiling grid.

Includes:

- (2) T-bar clips
- (2) Ceiling Couplers
- (2) 2" Canopies
- (2) Top Clamp Cable Grippers
- (2) x 1/16"x60" stainless steel aircraft cables with barrel ends

T-bar Kit SKU: FP-TBTC60

Panel Thickness: 1/4"

ADD SKU: FP-DG25ZTC500SAT (2 Large Grippers)
Panel Thickness: 3/8" and 1/2" Panels

Additional

T-Bar Grids are typically non-load bearing therefore cable must be attached from the top of the T Bar clip to a structural member with wire supplied by others.

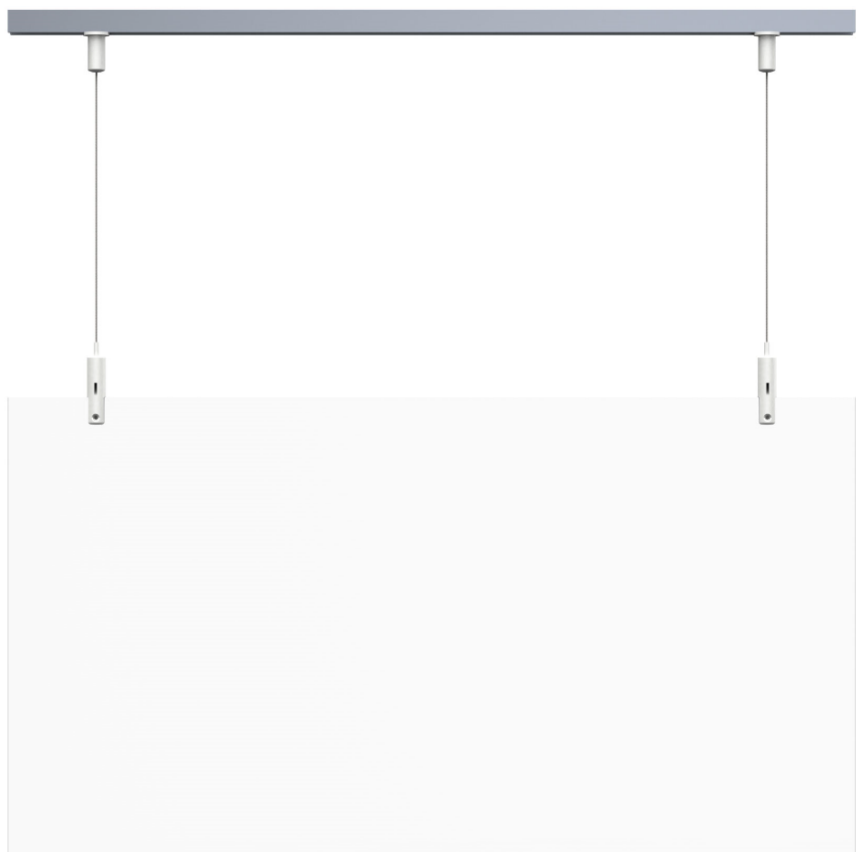

TRACK SUSPENSION

Description: Kit used for attaching to a solid ceiling.

Includes:

- (1) 80" Aluminum Ceiling Track
- (2) Ceiling Couplers (can be moved horizontally along track)
- (2) Top Clamp Cable Grippers
- (2) x 1/16"x60" stainless steel aircraft cables
- Ceiling Track Fasteners Not Included

Track Kit SKU: FP-TRKTC60

Panel Thickness: 1/4"

ADD SKU: FP-DG25ZTC500SAT (2 Large Grippers)
Panel Thickness: 3/8" and 1/2"

Additional

Each kit is supplied with two suspension points which provides an overall safe working load of 120lbs.

PANEL FEATURES

- Smooth Surface for Effective Cleaning
- Polycarbonate Panels Include A U Channel That Covers All Edges
- Polycarbonate Panels Impact Resistance is 200x's Greater Than Glass and 10x's Greater Than Acrylic
- Light Weight Simplifies Moving
- Customizable Sizes
- Cost Effective

WEIGHTS

PVC		POLYCARBONATE	
1/4"X48"X84"	18 LBS	3/8"X48"X84"	10 LBS
3/8"X48"X84"	27 LBS		
1/2"X48"X84"	35 LBS	PVC STAND	12 LBS

STORAGE AND CARE OF PVC AND POLYCARBONATE PANELS

Painting PVC

- Denatured alcohol can be used for surface cleaning and paint preparation.
- Apply PVC primer prior to final topcoat of choice.

Cleaning PVC and Polycarbonate Panels

- Use warm water with and a mild detergent like Dawn or a plastic safe cleaner. Gently wipe on/off with a micro-fiber towel.
- Do not use Ammonia, alcohol or bleach products that exceed a .5% solution, harsh chemicals and abrasive elements. They can cause damage to the surface of the polycarbonate panels.

Storage and Handling Panels

- Store items on a flat and clean surface.
- Keep product free of dirt and debris.

Warranty

5 YEAR LIMITED WARRANTY FOR PVC AND POLYCARBONATE PRODUCTS

Fuller Architectural Panels (hereinafter "Manufacturer") warrants that PVC and Polycarbonate products will not rot, splinter or suffer structural damage from termite or fungal decay for a period of five (5) years from Fuller Architectural Panels. Fuller Architectural PVC Products are "Expanded Foam PVC (polyvinyl chloride) and Polycarbonate Multi Wall sheets. "Purchaser's sole remedy for any claim whatsoever, whether in contract, warranty, tort, or strict liability, arising out of the use, storage or possession of Fuller Architectural Panels, including without limitation any claim that Fuller Architectural Panels fail to perform as warranted, shall be replaced with Fuller Architectural Panels. To obtain replacement, the original owner must submit this warranty certificate, with the original purchase invoice indicating the date of purchase, picture of the defective product and detailed description to Fuller Architectural Panels, 2009 Fairview Road #6731 Raleigh, North Carolina 27628. MANUFACTURER'S LIABILITY UNDER WARRANTY IS LIMITED SOLELY TO REPLACEMENT OF DEFECTIVE PRODUCT. THIS WARRANTY SHALL NOT APPLY TO PRODUCT WHICH HAS NOT BEEN INSTALLED IN ACCORDANCE WITH INSTALLATION GUIDELINES SPECIFIED IN THE MANUFACTURER'S "INSTALLATION INSTRUCTIONS", OR TO PRODUCT WHICH HAS BEEN AUSED, PLACED UNDER OR SUBJECTED TO ABNORMAL USE CONDITIONS OR USED, MODIFIED OR OTEHRWISE TREATED IN ANY MANNER OTHER THAN AS INTENDED BY MANUFACTURER. IN NO EVENT SHALL MANUFACTURER BE LIABLE FOR LABOR, EXEMPLARY OR CONSEQUENTIAL DAMAGES OF ANY KIND WHATSOEVER. PURCHASER IS SOLELY RESPONSIBLE FOR DETERMINING THE SUITABILITY OF USE OR APPLICATION OF ANY FULLER ARCHITECTURAL PRODUCT, OR WHETHER PRODUCT MEETS REQUIREMENTS OF APPLICABLE BUILDING CODES OR SAFETY CODES FOR SPECIFIC APPLICATIONS. No person or entity is Authorized by Manufacturer to make, and Manufacturer shall not be bound by any statement or representation as to the performance of Fuller Architectural Panels products other than amended or altered except in a written instrument signed by Manufacturer and Purchaser.