

SKU: FP700
46"X94"

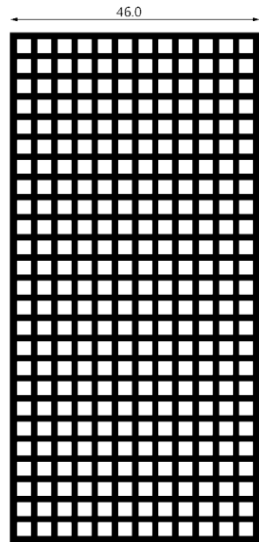

SKU: FP701

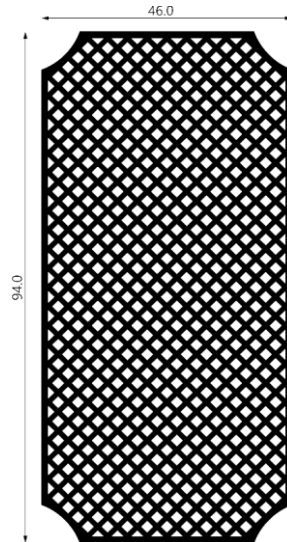

SKU: FP702

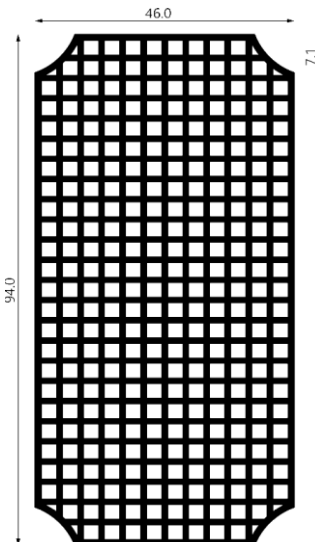

SKU: FP703

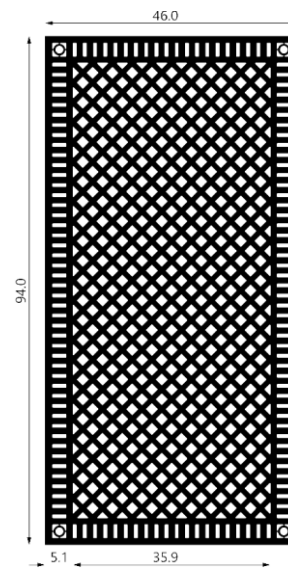

SKU: FP704

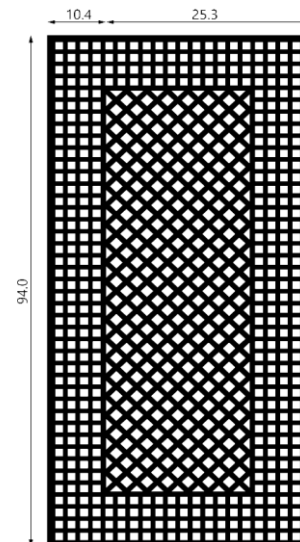

SKU: FP705

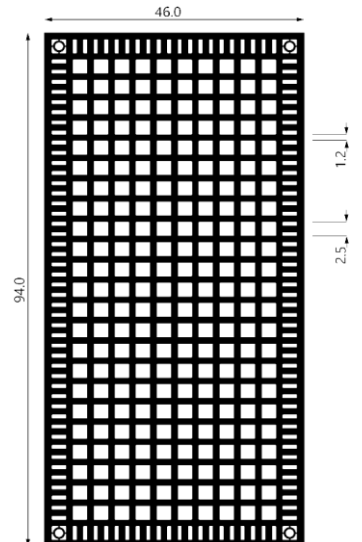

SKU: FP706

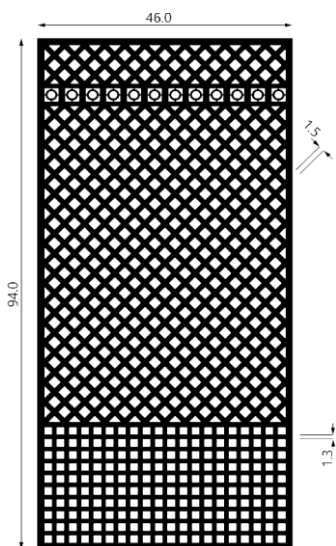

SKU: FP707
46"X94"

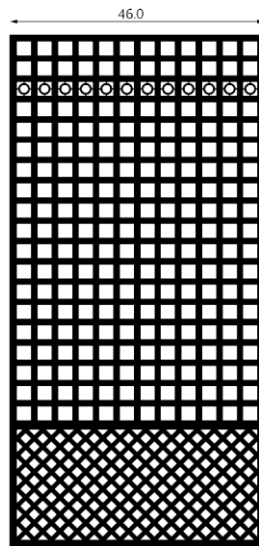

SKU: FP708

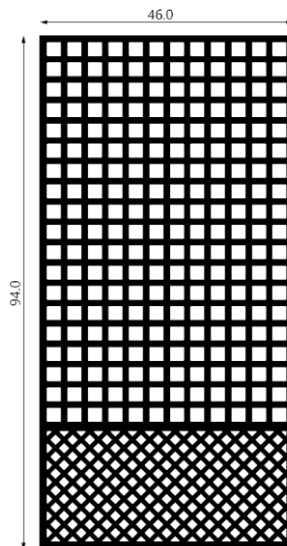

SKU: FP709

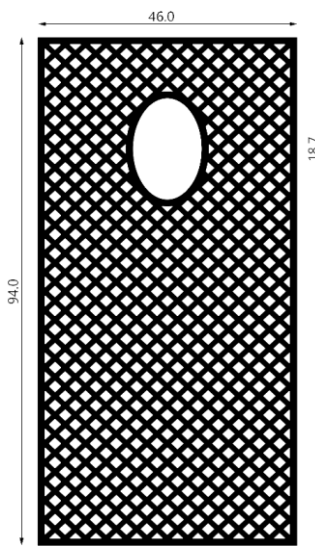

SKU: FP710

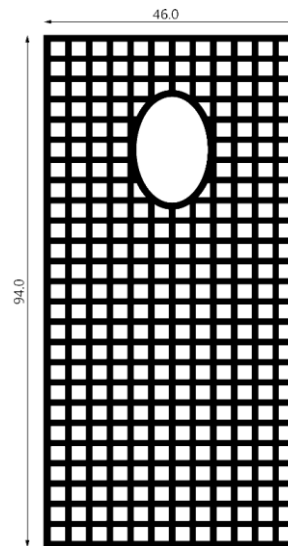

SKU: FP711

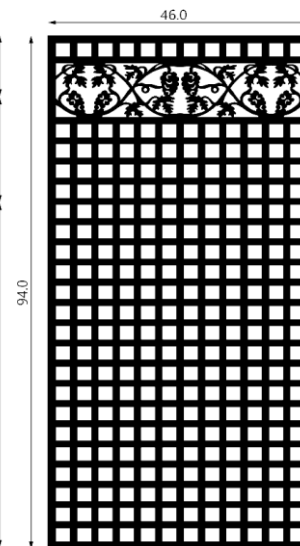

SKU: FP712

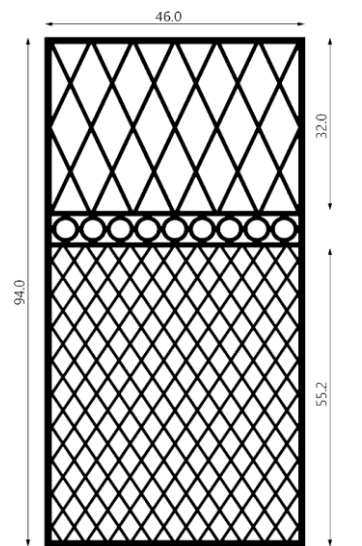

SKU: FP714
(REQUIRES CLEAN PASS)

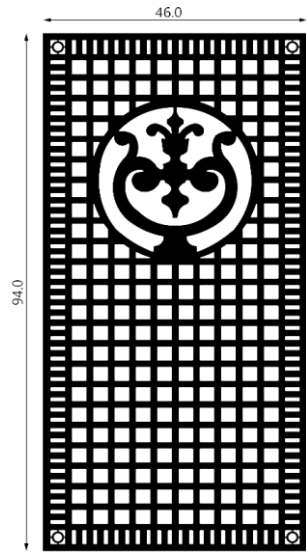

SKU: FP715
46"X94"

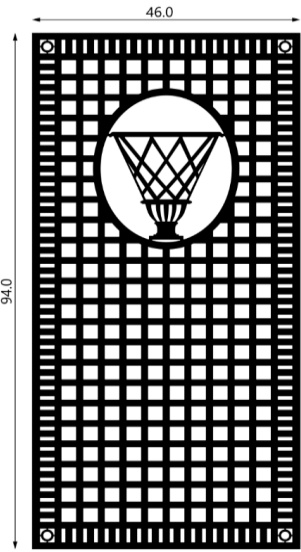

SKU: FP716

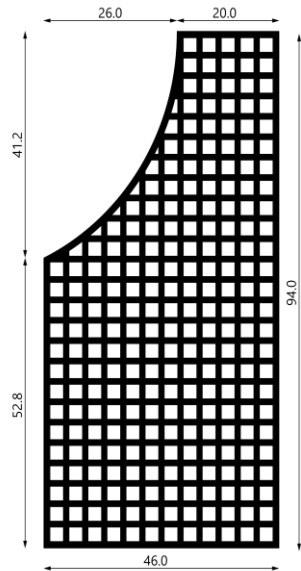

SKU: FP717

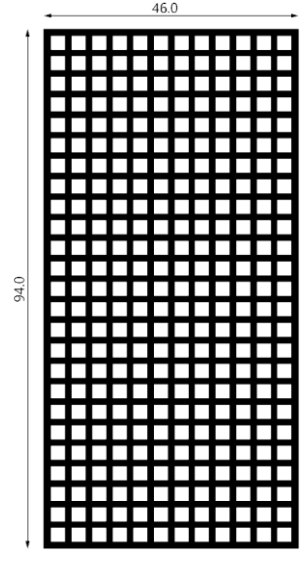

SKU: FP701

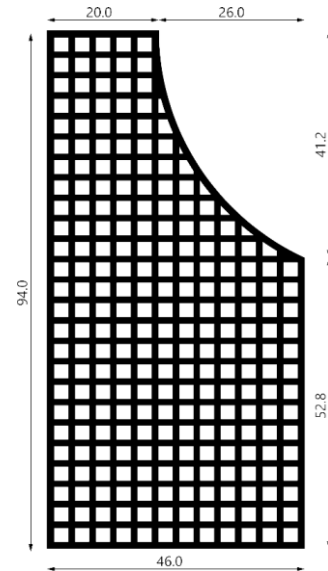

SKU: FP719

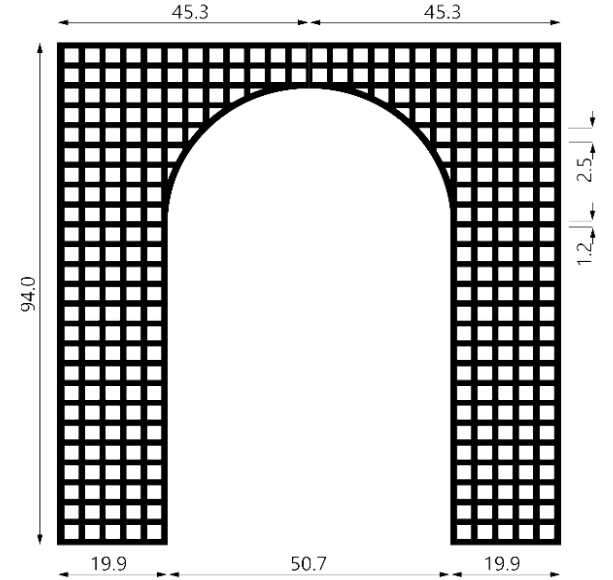

SKU: FP726 94"X90.6"

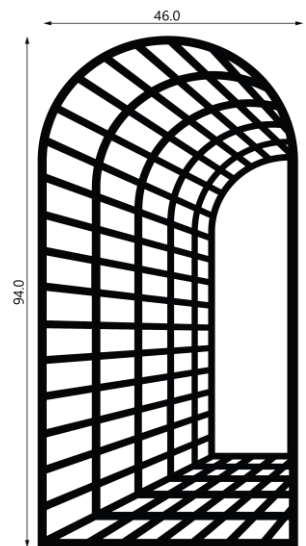

SKU: FP720
46"X94"

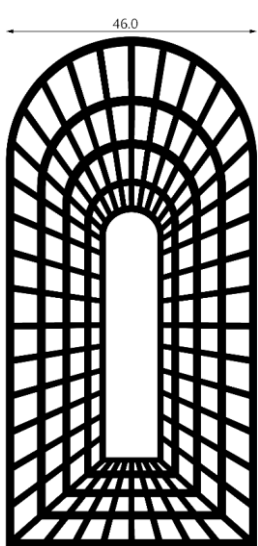

SKU: FP721

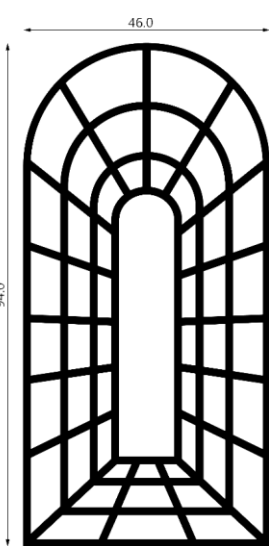

SKU: FP722

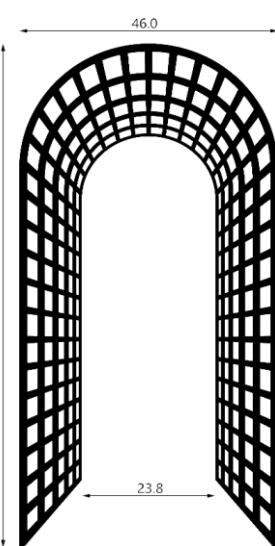

SKU: FP723

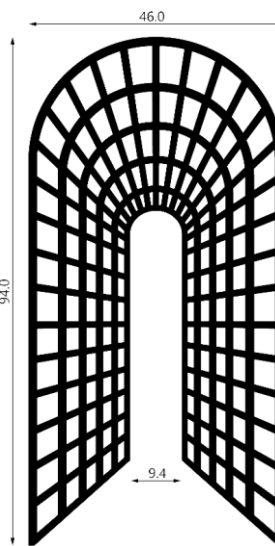

SKU: FP724

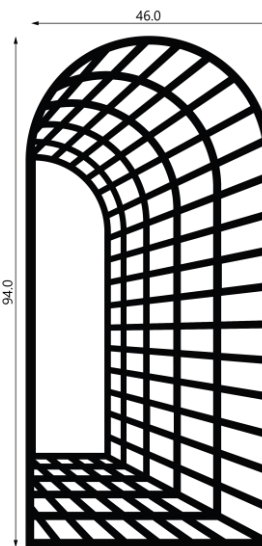

SKU: FP725

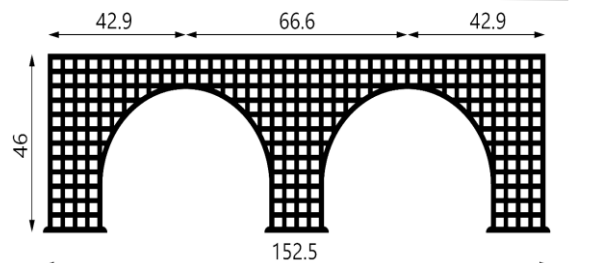

SKU: FP727 46"X152.4"

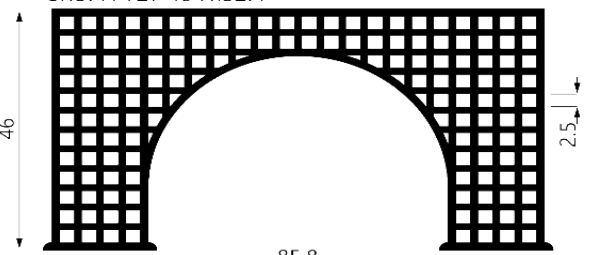

SKU: FP728 46"X85.8"

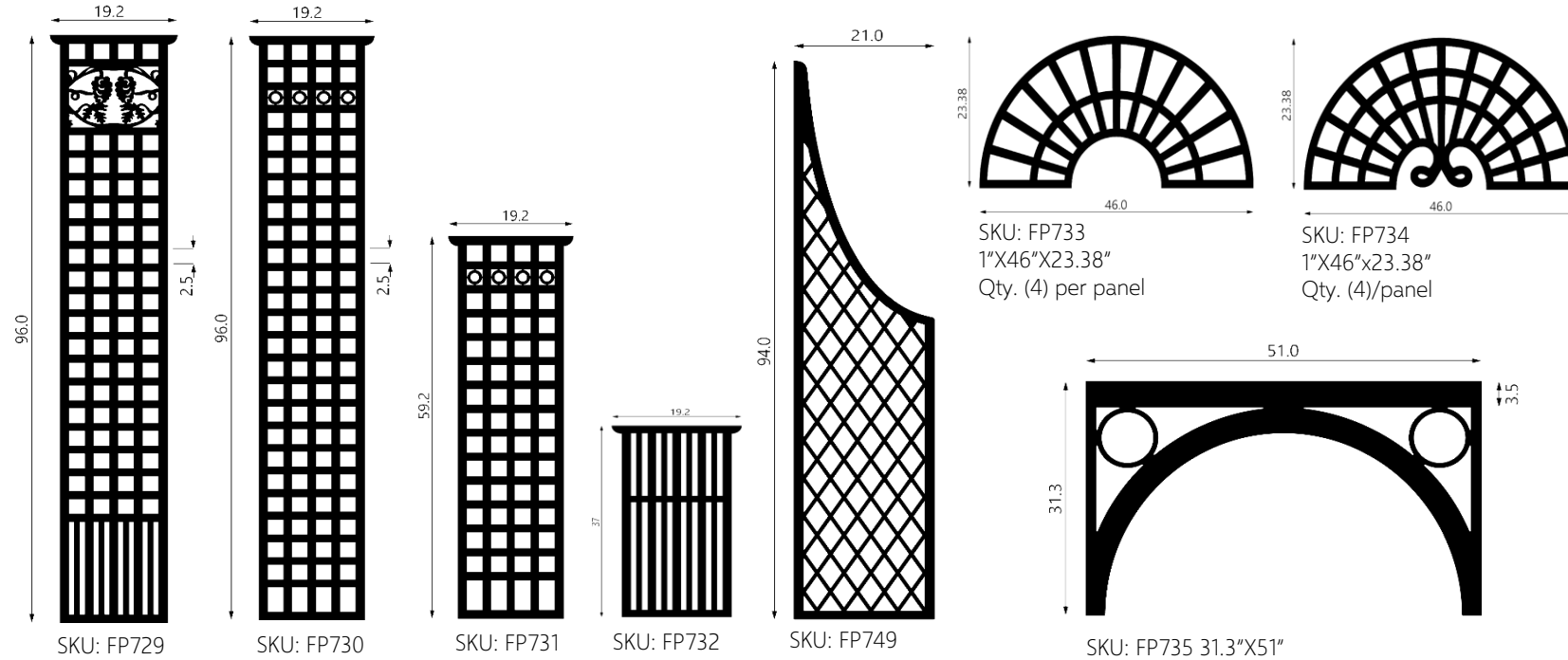

The Treillage product line is specifically designed to be interchangeable and customizable.

Our creative approach enables an endless combination of products while simplifying the design process.

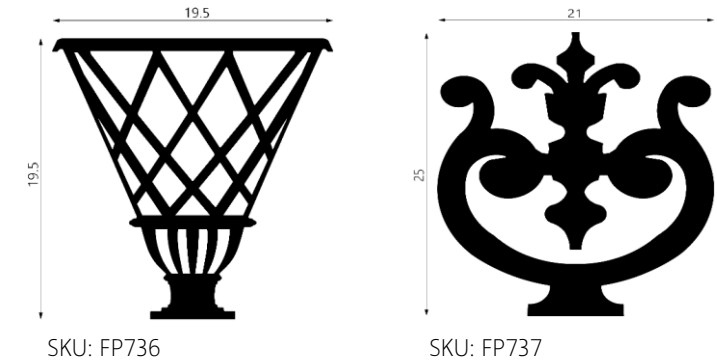

FRISE

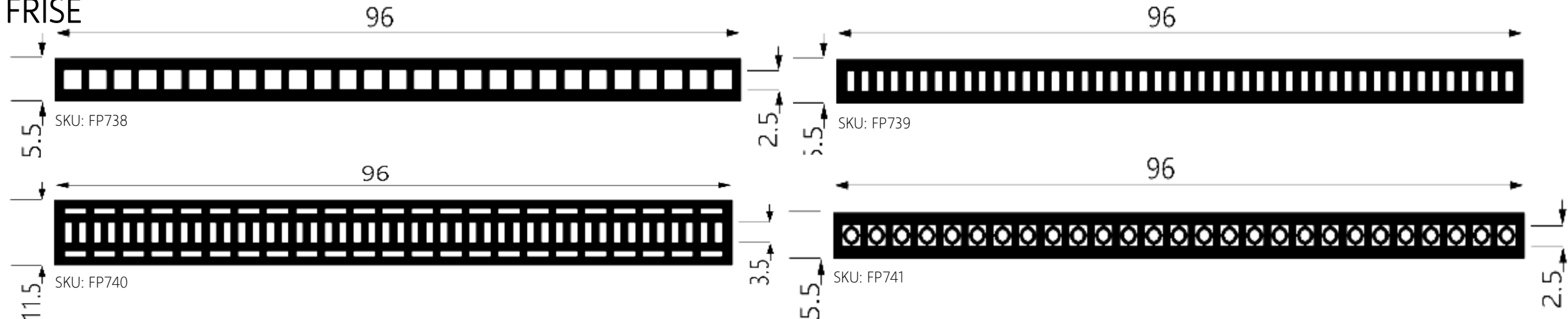

TREILLAGE & LATTICE BORDERS

Borders are fabricated with either a $\frac{1}{4}$ " or $\frac{1}{2}$ " rabbit on the back to allow for quick and precise placement of the panel.

All border sizes and designs are customizable.

Custom design requests are welcomed and expected.

PVC material is available in black or white.

The standard border thickness is $\frac{3}{4}$ " although can be fabricated out of material up to 1- $\frac{1}{2}$ " thick in white and up to 1" in black.

The standard border dimension is $\frac{3}{4}$ "x5.6"x96"

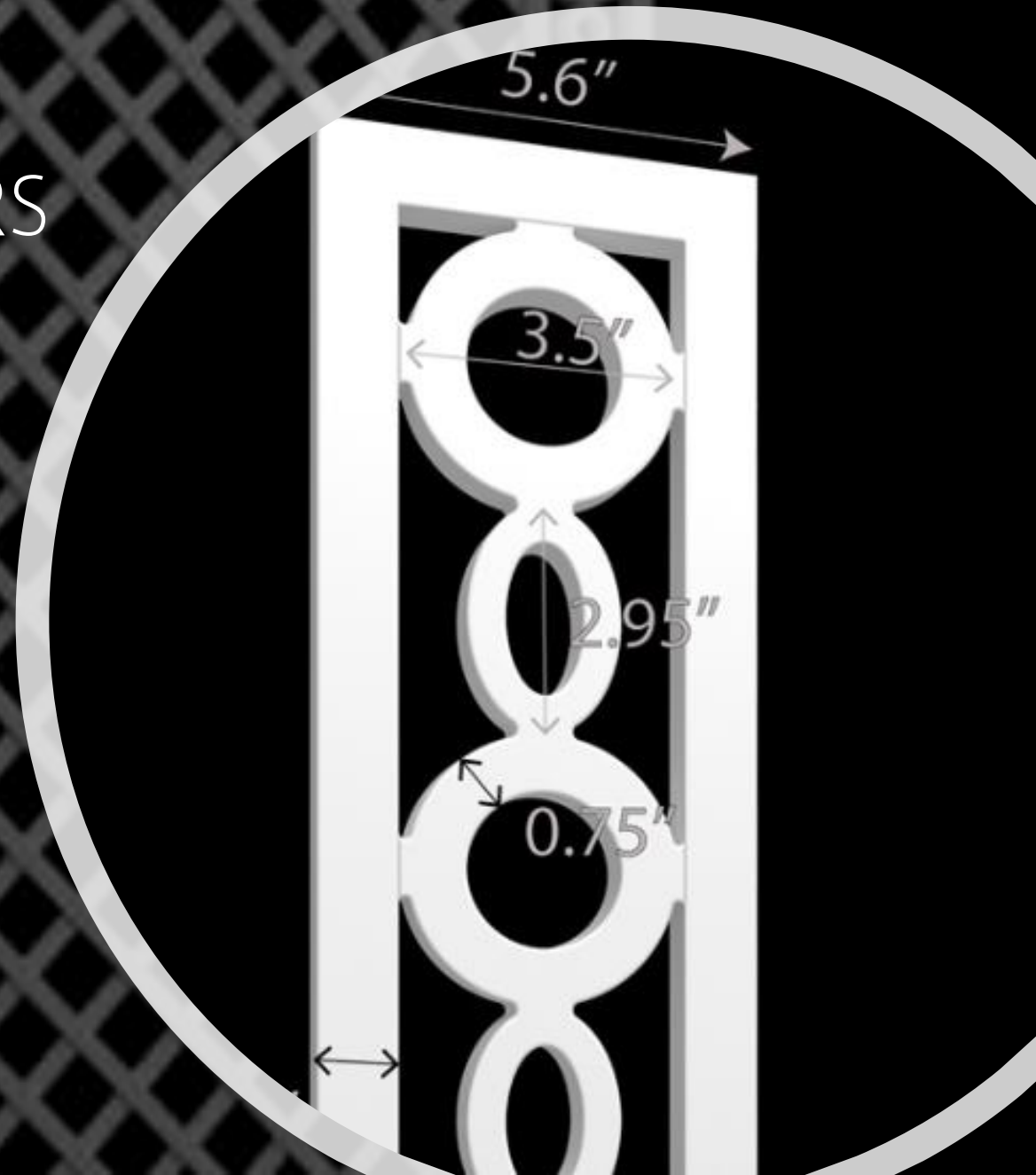

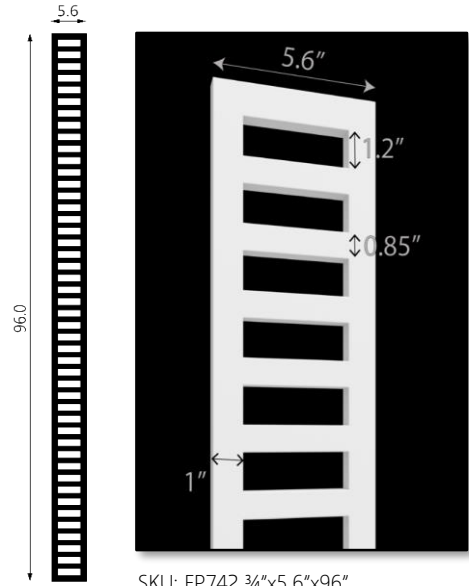

SKU: FP742 3/4"x5.6"x96"

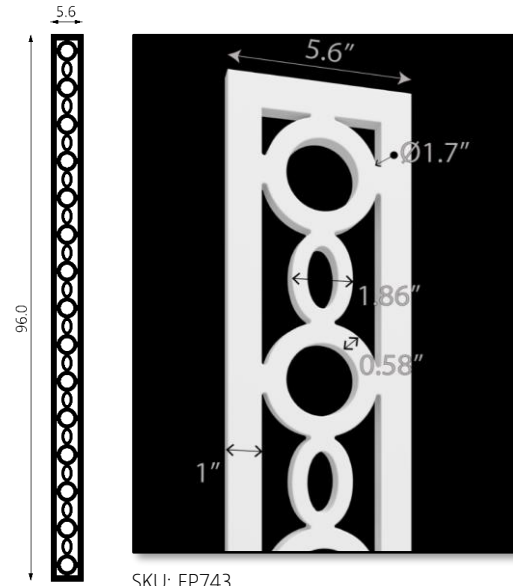

SKU: FP743

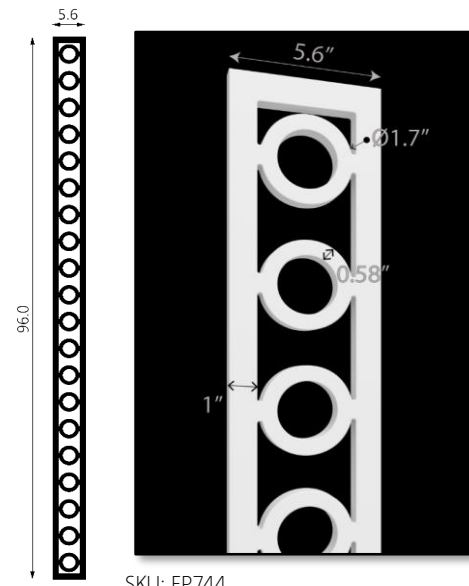

SKU: FP744

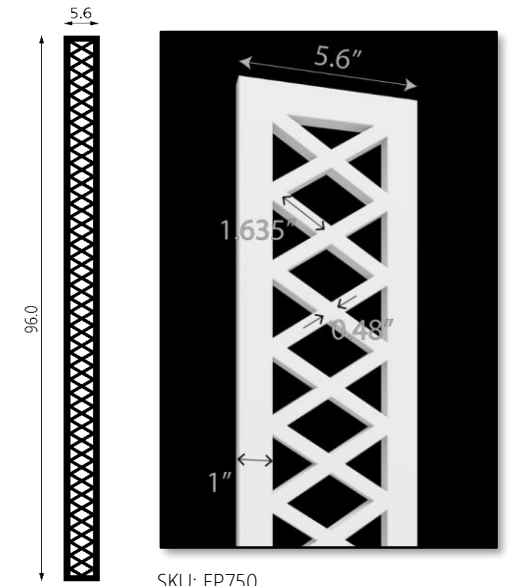

SKU: FP750

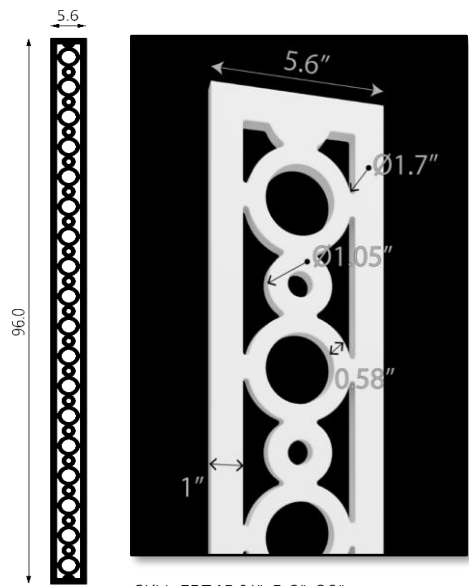

SKU: FP745 3/4"x5.6"x96"

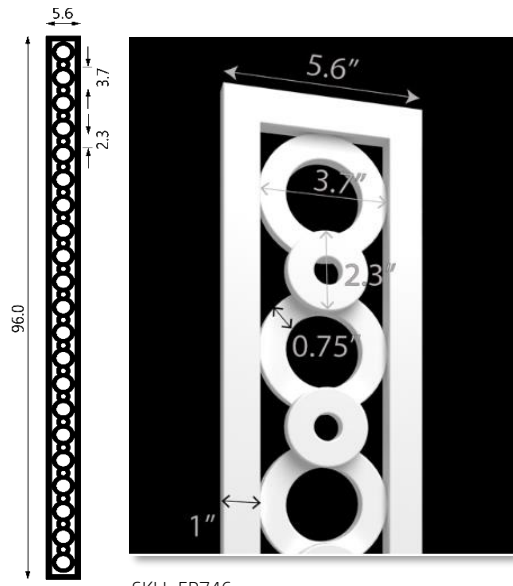

SKU: FP746

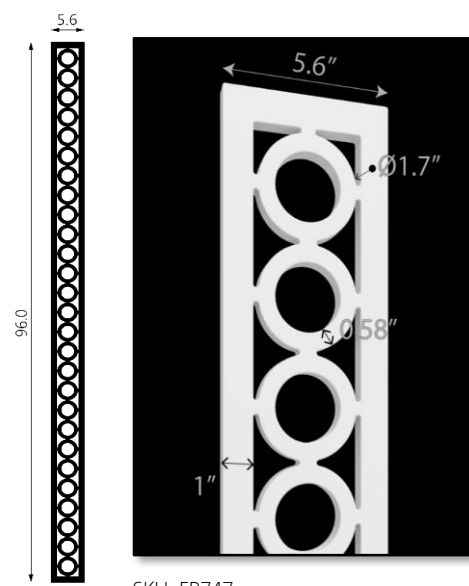

SKU: FP747

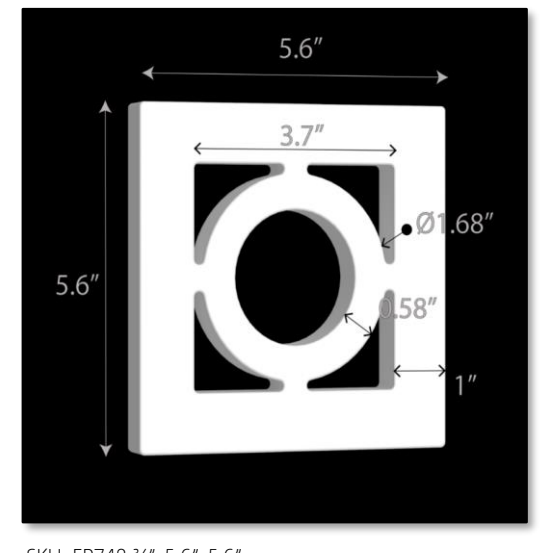

SKU: FP748 3/4"x5.6"x5.6"

Milling Options



Single Mill Panel With Custom Dimensioned Border
Interior Design Firm Betsy Anderson Interiors

We offer (4) panel profiles of which are customizable in square orientation, opening size and slat dimension.

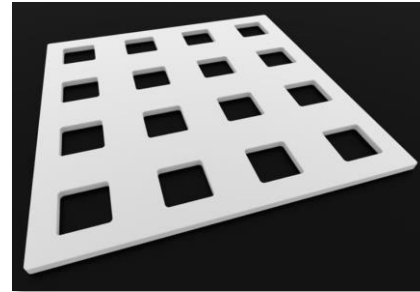

Type: **Single Bore Panel**
Min. Thickness 1/4" (.25")
Max. Panel Size 48"x96"

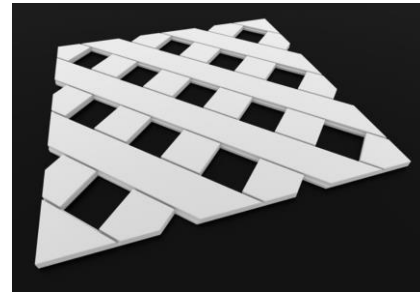

Type: **Scored Panel**
Min. Thickness 1/4" (.25")
Max. Panel Size 48"x96"

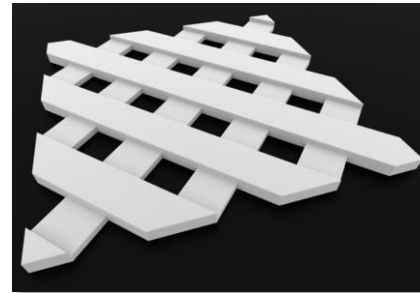

Type: **Single Mill Panel**
Min. Thickness: 1/2" (.50")
Max. Panel Size: 46"x94"

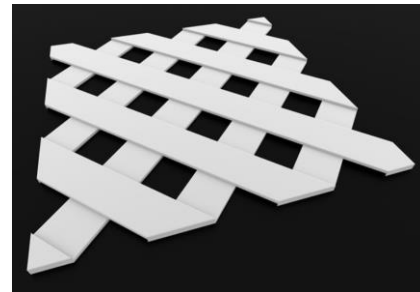

Type: **Double Mill Panel**
Min. Thickness 1/2" (.50")
Max. Panel Size 46"x94"

Sophistication Simplified

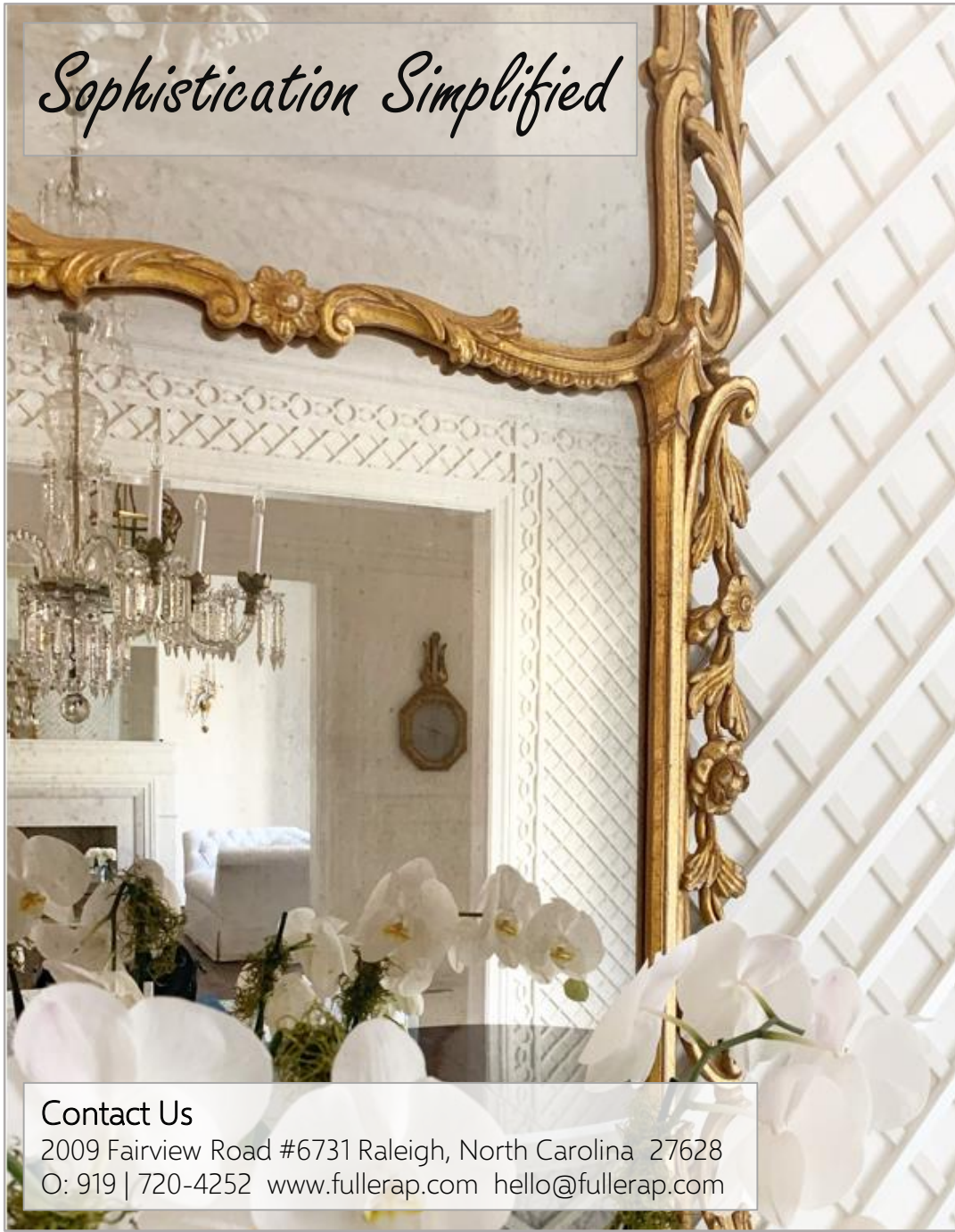

Contact Us

2009 Fairview Road #6731 Raleigh, North Carolina 27628
O: 919 | 720-4252 www.fullerap.com hello@fullerap.com

Installation

- Install using conventional woodworking techniques including adhesives and/or fasteners.
- Carbide tipped blades are recommended.
- Standard PVC cements or Cellular PVC cements provide a strong bond. Glue all joints to prevent separation.

Finishing

- Sand imperfections in material.
- Wipe with acetone or similar prior to applying PVC primer.
- Fill any gaps and fastener holes with PVC approved caulk or similar prior to applying primer.
- Apply PVC approved primer prior to final topcoat of choice.

Touch Up

- Recommend non solvent based fillers such as all-purpose painter's putty, high performance wood filler or latex caulk.

Storage and Handling

- Store items on a flat surface.
- Keep product free of dirt and debris. If items get dirty use warm water with detergent to clean.

Additional

- Available Raw Material Colors: White & Black
- Available Thicknesses; 1/4", 1/2", 3/4", 1" and 1-1/2"
- Standard dimensions subject to change without notice.
- Allow 4-6 weeks to fulfill your order from design approval.
- Custom projects require a 50% deposit with full payment due prior to shipment.
- 20% restock fee on approved returns. Custom projects are not returnable.
- Pricing is USD and does not include packaging, shipping and applicable taxes.

Warranty

5 YEAR LIMITED WARRANTY FOR PVC PRODUCTS

Fuller Architectural Panels (hereinafter "Manufacturer") warrants that PVC products will not rot, split or suffer structural damage from termite or fungal decay for a period of ten (5) years from Fuller Architectural Panels. Fuller Architectural PVC Products are "Expanded Foam PVC (polyvinyl chloride) sheets." Purchaser's sole remedy for any claim whatsoever, whether in contract, warranty, tort, or strict liability, arising out of the use, storage or possession of Fuller Architectural Panels, including without limitation any claim that Fuller Architectural Panels fail to perform as warranted, shall be replaced with Fuller Architectural Panels. To obtain replacement, the original owner must submit this warranty certificate, with the original purchase invoice indicating the date of purchase, picture of the defective product and detailed description to Fuller Architectural Panels, 2009 Fairview Road #6731 Raleigh, North Carolina 27628. MANUFACTURER'S LIABILITY UNDER WARRANTY IS LIMITED SOLELY TO REPLACEMENT OF DEFECTIVE PRODUCT. THIS WARRANTY SHALL NOT APPLY TO PRODUCT WHICH HAS NOT BEEN INSTALLED IN ACCORDANCE WITH INSTALLATION GUIDELINES SPECIFIED IN THE MANUFACTURER'S "INSTALLATION INSTRUCTIONS", OR TO PRODUCT WHICH HAS BEEN AUSED, PLACED UNDER OR SUBJECTED TO ABNORMAL USE CONDITIONS OR USED, MODIFIED OR OTHERWISE TREATED IN ANY MANNER OTHER THAN AS INTENDED BY MANUFACTURER. IN NO EVENT SHALL MANUFACTURER BE LIABLE FOR LABOR, EXEMPLARY OR CONSEQUENTIAL DAMAGES OF ANY KIND WHATSOEVER. PURCHASER IS SOLELY RESPONSIBLE FOR DETERMINING THE SUITABILITY OF USE OR APPLICATION OF ANY FULLER ARCHITECTURAL PRODUCT, OR WHETHER PRODUCT MEETS REQUIREMENTS OF APPLICABLE BUILDING CODES OR SAFETY CODES FOR SPECIFIC APPLICATIONS. No person or entity is Authorized by Manufacturer to make, and Manufacturer shall not be bound by any statement or representation as to the performance of Fuller Architectural Panels products other than amended or altered except in a written instrument signed by Manufacturer and Purchaser.