

RESIDENTIAL  
RESIDENCIAL  
/22



# ÍNDICE /

INDEX · TABLE · ИНДЕКС

<b>SIMBOLOGÍA</b> ICONOGRAPHY	02	<b>ESQUEMAS DE COLOCACIÓN MF</b> MULTIFORMAT LAYING PATTERNS	342 - 343
<b>ÍNDICE SERIES</b> SERIES INDEX	03	<b>SOLUCIONES TÉCNICAS</b> TECHNICAL SOLUTIONS	344 - 359
<b>SOBRE NOSOTROS</b> ABOUT US	04 - 11	<b>RECOMENDACIONES COLOCACIÓN</b> TILING RECOMMENDATIONS	360 - 363
<b>SERIES MARBLE</b> MARBLE SERIES	12 - 105	<b>PROCESO EXTRUSIÓN</b> EXTRUSION PROCESS	364 - 365
<b>SERIES WOOD</b> WOOD SERIES	106 - 165	<b>CARACTERÍSTICAS TÉCNICAS</b> TECHNICAL DATA	366 - 373
<b>SERIES URBAN</b> URBAN SERIES	166 - 227	<b>LISTA DE EMBALAJE</b> PACKING LIST	374 - 383
<b>SERIES STONE</b> STONE SERIES	228 - 329		
<b>SERIES EARTH</b> EARTH SERIES	330 - 335		
<b>SERIES METAL</b> METAL SERIES	336 - 341		

# SIMBOLOGÍA /

## ICONOGRAPHY · ICONOGRAPHIE · УСЛОВНЫЕ ОБОЗНАЧЕНИЯ

 **ANTIBACTERIANO** [Eficacia del 99,9% según norma JIS Z 2801:2010] · **ANTIBACTERIAL** [Efficiency of 99.9% according to JIS Z 2801:2010 standard]  
ANTIBACTERIEN [Efficacité de 99,9% selon la norme JIS Z 2801:2010] · **АНТИБАКТЕРИАЛЬНЫЕ** [Эффективность 99,9% в соответствии со стандартом JIS Z 2801:2010]

 **RESISTENCIA AL DESLIZAMIENTO (rampa pie calzado)** · **ANTI-SLIP RESISTANCE (ramp)**  
RÉSISTANCE AU GLISSEMENT (pied chaussé) · **СОПРОТИВЛЕНИЕ СКОЛЬЖЕНИЮ** (если ходит обутым)

 **RESISTENCIA AL DESLIZAMIENTO (pie descalzo)** · **ANTI-SLIP RESISTANCE (barefoot)**  
RÉSISTANCE AU GLISSEMENT (pied nu) · **СОПРОТИВЛЕНИЕ СКОЛЬЖЕНИЮ** (босые ноги)

 **RESISTENCIA AL DESLIZAMIENTO (C.T.E.)** · **ANTI-SLIP RESISTANCE (C.T.E.)**  
RÉSISTANCE AU GLISSEMENT (C.T.E.) · **СОПРОТИВЛЕНИЕ СКОЛЬЖЕНИЮ** (C.T.E.)

 **RESISTENCIA A LA FLEXIÓN** · **MODULUS OF RUPTURE**  
RÉSISTANCE À LA FLEXION · **СОПРОТИВЛЕНИЕ НА ИЗГИБ**

 **RESISTENCIA AL CUARTEO** · **CRACKING RESISTANCE**  
RÉSISTANCE AU TRESSAILLAGE · **УСТОЙЧИВОСТЬ К РАСТРЕСКИВАНИЮ**

 **ABSORCIÓN DE AGUA** · **WATER ABSORPTION**  
ABSORTION D'EAU · **ВОДОПОГЛОЩЕНИЕ**

 **RESISTENCIA A LOS AGENTES QUÍMICOS** · **CHEMICAL RESISTANCE**  
RÉSISTANCE AUX PRODUITS CHIMIQUES · **СТОЙКОСТЬ К ВОЗДЕЙСТВИЮ ХИМИКАТОВ**

 **RESISTENCIA A LA HELADA** · **FROST RESISTANCE**  
RÉSISTANCE AU GEL · **МОРОЗОСТОЙКОСТЬ**

 **IMPRESIÓN DIGITAL** · **DIGITAL PRINTING**  
DIGITAL IMPRESSION · **ЦИФРОВАЯ ПЕЧАТЬ**

 **DORSO ESTRIADO EN COLA DE MILANO** · **DOVE TAIL PROFILE**  
FAÇONNAGE EN QUEUE D'ARONDE AU DOS DES CARREAUX · **Ласточкин хвост** на задней стороне плитк

 **LIGERA VARIACIÓN EN TONALIDAD Y GRÁFICAS** · **SLIGHT VARIATION IN SHADE AND GRAPHICS**  
LÉGÈRE VARIATION DE LA TEINTE ET DES GRAPHIQUES · **НЕБОЛЬШОЕ РАЗЛИЧИЕ В ОТТЕНКАХ И РИСУНКАХ**

 **MODERADA VARIACIÓN EN TONALIDAD Y GRÁFICAS** · **MODERATE VARIATION IN SHADE AND GRAPHICS**  
VARIATION MODÉRÉE DE LA TEINTE ET DES GRAPHIQUES · **СРЕДНЕЕ РАЗЛИЧИЕ В ОТТЕНКАХ И РИСУНКАХ**

 **CONTRASTE DE TONALIDAD Y VARIEDAD DE GRÁFICAS** · **CONTRAST IN SHADE AND VARIETY OF GRAPHICS**  
CONTRASTE DE TEINTE ET VARIÉTÉ DE GRAPHIQUES · **КОНТРАСТНЫЕ ОТТЕНКИ И РАЗНООБРАЗИЕ РИСУНКОВ**

 **RELIEVE SUPERFICIAL** · **SUPERFICIAL RELIEF**  
RELIEF SUPERFICIEL · **РЕЛЬЕФНАЯ ПОВЕРХНОСТЬ**

 **RECTIFICADO** · **RECTIFIED**  
CARRELAGE RECTIFIÉ · **РЕКТИФИЦИРОВАННАЯ ПЛИТКА**

 **DISEÑO 3D** · **3D DESIGN**  
DESIGN 3D · **ДИЗАЙН 3D**

 **NO REJUNTAR - NO PEGAR** · **DO NOT GROUT - DO NOT GLUE**  
NE PAS JOINTOYER - NE PAS COLLER · **НЕ ЗАТИРАТЬ - НЕ КЛЕИТЬ**

# ÍNDICE SERIES /

## SERIES INDEX · TABLE DES SÉRIES · СОДЕРЖАНИЕ

### 1. MARBLE

IMPERIAL	12 - 45
VENATTO	46 - 59
NUBIA	60 - 69
OROBICO	70 - 81
MARBLES	82 - 93
MARKINA	94 - 105

### 2. WOOD

LIZANA	106 - 141
YOHO	142 - 159
NATURA	160 - 165

### 3. URBAN

COSMOS	166 - 197
ÓPERA	198 - 221
MEDITERRÁNEO	222 - 227

### 4. STONE

ARDENAS/ARDENAS 	228 - 275
MILÁN	276 - 291
ALBAROC	292 - 301
LITOS	302 - 311
MANHATTAN	312 - 319
PETRA	320 - 325
VEGA	326 - 329

### 5. EARTH

ALHAMAR	330 - 335
---------	-----------

### 6. METAL

METÁLICA	336 - 341
----------	-----------

## EMPRESA /

COMPANY · ENTERPRISE · КОМПАНИЯ

A principios de los años 70, EXAGRES se introduce en el mercado del extruido. Desde su fundación, la empresa desempeña un papel fundamental de liderazgo en la investigación de materias primas y procesos productivos, poniendo al alcance de grandes profesionales, soluciones en la aplicación cerámica, desarrollando piezas especiales como peldaños, esquinas, ángulos, vierteaguas, bordes de piscinas, etc. que posicionan a Exagres, como líder en la fabricación en Europa. Pero esta Innovación y Desarrollo se traslada al mercado en voz de un equipo con talento, cercano y a la escucha de cada una de las necesidades de clientes y profesionales. En la actualidad, Exagres se afianza, con la seguridad de 40 años de innovación tecnológica, conocimiento y entendimiento de múltiples necesidades para lograr productos de calidad y crear valor añadido a través una cultura de gestión integral y mejora continua, fundamentada en la calidad del servicio y producto, la protección ambiental, la seguridad y salud de las personas que forman parte de nuestra empresa.

At the beginning of the 70s, EXAGRES joined the market of extruded products. Since it was founded, the company has played a fundamental role in the leadership researching raw materials and production processes, providing solutions for ceramic applications in the hands of great professionals, developing special pieces such as steps, corners, angles, gutters, pool edging, etc. these facts position Exagres as a leading manufacturer in Europe. Innovation and development are transferred to the market through the voice of a talented, friendly team that is capable to listen to each of the needs of their customers and professionals. Currently, Exagres is strengthened of 40 years of technological innovation, knowledge and understanding of multiple needs in order to achieve quality products, creating added value through a culture of integral management and continuous improvement, based on the quality of the service and product, environmental protection and the health and safety of the people who form part of our company.

Au début des années 70, EXAGRES pénètre dans le marché de l'extrusion. Depuis sa fondation, l'entreprise remplit un rôle essentiel de leadership dans la recherche de matières premières et processus de production, mettant à la portée des grands professionnels des solutions dans l'application céramique, en développant des pièces spéciales telles que des marches, des coins, des angles, des revingots, des rebords de piscines, etc., qui placent Exagres à la tête de la fabrication en Europe. Cependant, cette innovation et ce développement sont transférés au marché au nom d'une équipe talentueuse, proche et à l'écoute de chacune des nécessités de clients et professionnels. À présent, Exagres se consolide, avec la sécurité de 40 ans d'innovation technologique, connaissance et compréhension de nécessités multiples pour obtenir des produits de qualité et créer de la valeur ajoutée à travers une culture de gestion intégrale et amélioration continue, qui se fonde sur la qualité du service et du produit, la protection environnementale, la sécurité et la santé des personnes qui font partie de notre entreprise.

Компания EXAGRES начала свою деятельность на рынке экструдированной керамики в начале 70-х годов. С момента своего основания она стала одним из лидеров в научных исследованиях в области первичного сырья и производственных процессов, занимая ведущую позицию среди производителей в Европе. Exagres предлагает профессионалам различные решения в области применения керамики, в том числе специальные элементы: ступени, внутренние и внешние углы, водостоки, бортики бассейнов и др. Инновации и опытные разработки осуществляет команда талантливых сотрудников, которые внимательно относятся к мнению клиентов и профессионалов, стремясь удовлетворять все их потребности. Exagres имеет 40-летний опыт в области технологических инноваций. Ее персонал располагает обширными знаниями, в том числе о различных потребностях и запросах, что позволяет создавать высококачественные продукты с дополнительной ценностью. В компании существует особая культура комплексного менеджмента и постоянного совершенствования, основанная на качестве услуг и продукции, защите окружающей среды, а также на обеспечении безопасности и охране здоровья трудящихся.

## PRODUCTO /

PRODUCT · PRODUIT · ПРОДУКТЫ

Las exigencias en arquitectura varían con el paso de los años, por ello, EXAGRES propone soluciones y superficies que garantizan altos niveles de prestaciones técnicas y estéticas a la vez que respetan las necesidades de la construcción. El producto de Exagres, con su particular sistema de fabricación, la extrusión, es capaz de generar diferentes formatos y tipos de piezas especiales, todo ello, facilitando su colocación al profesional.

Las series de Exagres garantizan funcionalidad y un alto contenido estético en cada tipo de proyecto. Desde la arquitectura urbana, el uso industrial e incluso en la realización de todo tipo de diseños de carácter residencial en interiores, exteriores y recubrimiento de piscinas.

The requirements of architecture vary over time, therefore, EXAGRES proposes solutions and surfaces that guarantee high levels of technical and aesthetic qualities while also respecting the needs of the construction.

The Exagres product, with its unique manufacturing system, extrusion, is capable of generating different formats and types of special pieces, thus facilitating placement by a professional.

The Exagres series guarantee functionality and a high aesthetic content in each type of project. From urban architecture, industrial use and even use in all types of designs of a residential nature for interiors, exteriors and swimming pool cladding.

Les exigences en architecture varient au fil des années. De ce fait, EXAGRES propose des solutions et des surfaces qui garantissent de hauts niveaux de prestations techniques et esthétiques en respectant en même temps les nécessités de la construction.

Le produit d'Exagres, avec son système particulier de fabrication, l'extrusion, est capable de générer plusieurs formats et types de pièces spéciales, le tout en facilitant sa pose au professionnel.

Les séries d'Exagres garantissent la fonctionnalité et une haute teneur esthétique dans chaque type de projet. Depuis l'architecture urbaine, l'utilisation industrielle et même dans la réalisation de toute sorte de conceptions à caractère résidentiel en intérieur, extérieur et recouvrement de piscines.

С течением времени требования, предъявляемые к различным материалам в архитектуре, варьируются. Поэтому EXAGRES предлагает решения, которые не только гарантируют высокий уровень технических и эстетических характеристик, но также обеспечивают соответствие потребностям строительства.

Продукты компании Exagres производятся с помощью особой технологии-экструзии, которая позволяет создавать различные форматы и элементы разных форм, что облегчает процесс укладки.

Серии Exagres гарантируют функциональность и прекрасные эстетические характеристики для каждого типа проекта, включая городскую архитектуру, промышленное использование, интерьеры и наружные пространства всевозможных жилых домов, а также покрытия для бассейнов.



## CERTIFICACIONES / CERTIFICATES · CERTIFICATS · СЕРТИФИКАТЫ

En Exagres somos responsables con el medio ambiente. Además utilizamos las herramientas de gestión adecuadas para garantizar la calidad, la protección del medio ambiente, la seguridad y la salud.

At Exagres we are environmentally responsible. For this reason we use the appropriate management tools to guarantee quality, environment, safety and health.

Chez Exagres nous sommes responsables de l'environnement. Pour cette raison, nous utilisons les outils de gestion adaptés afin de garantir la qualité, l'environnement, la sécurité et la santé.

В Exagres мы ответственно относимся к охране окружающей среды. Именно поэтому мы используем инструменты управления, обеспечивающие высокое качество продукции, защиту окружающей среды, безопасность и охрану здоровья.



**ISO 9001: 2015**  
Sistemas de gestión de la calidad.  
Quality management systems.  
Systèmes de gestion de la qualité.  
Системы менеджмента качества.



**ISO 14001: 2015**  
Sistemas de gestión medioambiental.  
Environmental management systems.  
Systèmes de gestion environnementale.  
Системы экологического менеджмента.



**ISO 45001: 2018**  
Sistemas de gestión de la seguridad y salud en el trabajo.  
Occupational Health and Safety management systems.  
Systèmes de gestion de la santé et de la sécurité au travail.  
Системы управления охраной труда и промышленной безопасностью.

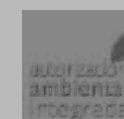

**AAI**  
Certificado Autorización Ambiental Integrada.  
Integrated Environmental Authorisation Certificate.  
Certificat d'autorisation environnementale intégrée.  
Интегрированное свидетельство об экологической авторизации.



Sello de reducción de huella de carbono.  
Carbon footprint reduction label.  
Label de réduction de l'empreinte carbone.  
Маркировка сокращения выбросов углекислого газа.



Declaración ambiental de producto.  
Environmental product declaration.  
Déclaration environnementale de produit.  
Экологическая декларация продукции.

## LIBRERÍA BIM /

BIM LIBRARY · BIBLIOTHÈQUE BIM · БИБЛИОТЕКА BIM

### BIM

Exagres se suma al sistema de trabajo en BIM, distribuyendo a los agentes intervinientes de la edificación sus productos cerámicos. Los modelos BIM contienen los datos necesarios para que los prescriptores puedan elegir el material siguiendo los criterios pertinentes para cada uso. Además, el arquitecto podrá generar imágenes de alta calidad, para poder mostrar a sus clientes el ambiente con mayor fidelidad.

Exagres joins the BIM work system, distributing its ceramic products to the agents involved in building. BIM models contain the required data in order to construction specifiers can choose the right material according to the relevant criteria for each use. Furthermore, the architect will be able to generate high quality images to show the environment to his customers with greater accuracy.

Exagres s'associe au système de travail BIM, en distribuant aux agents intervenants de la construction leur produits en céramique. Les modèles BIM contiennent les données nécessaires pour que les prescripteurs puissent choisir le matériel en suivant les critères pertinentes pour chaque usage. En plus, l'architecte pourra générer des images d'haute qualité, pour pouvoir montrer aux clients l'ambiance avec plus de fidélité.

Exagres присоединяется к современной системе информационного моделирования BIM, распределяя среди участвующих лиц достижения в керамической деятельности. Модели BIM содержат в себе все необходимые данные, позволяющие выбирать материал в соответствии с особенностями каждого использования. Кроме того, архитектор сможет генерировать высококачественные изображения и демонстрировать клиентам пространства с большей точностью.

## PREMIOS /

AWARDS · PRIX · ПРЕМИИ



En la edición de la Feria Cevisama 2019, la nueva línea de suelo técnico cerámico Exadeck de Exagres fue galardonado con el premio "SOM CERÀMICA", otorgado por la Diputación de Castellón en reconocimiento a la innovación del producto cerámico para su uso en aplicaciones urbanas.

In Cevisama Fair 2019, the new line of ceramic technical floor, Exadeck by Exagres, was awarded the SOM CERÀMICA prize by the Council of Castellón in recognition of the innovation of the ceramic product for use in urban applications.

Dans l'édition de la foire Cevisama 2019, la nouvelle ligne du sol technique céramique Exadeck d'Exagres a reçu le prix "SOM CERÀMICA" décerné par la Diputación de Castellón en récompense à l'innovation du produit céramique pour usage dans des applications urbaines.

На международной выставке Cevisama Fair 2019, Мария города Кастильон удостоила новую линию технического керамического пола Exadeck от Exagres, награды «SOM CERÀMICA», за достижения в области развития инновационного керамического продукта и его использования в городских условиях.



Video Premio "Som Ceràmica"

## RECONOCIMIENTOS /

RECOGNITION · RECONNAISSANCE · ПРИЗНАНИЕ



La Confederación Española de la Pequeña y Mediana Empresa (CEPYME) ha seleccionado a Exagres como una de las 500 empresas que lideran el crecimiento empresarial, tanto por sus resultados obtenidos en los últimos años, como por su capacidad para generar actividad y empleo, su potencial de innovación y su proyección internacional.

The Spanish Confederation of Small and Medium-Size Enterprises (CEPYME) has chosen Exagres as one of the 500 companies that lead business growth due to its results obtained in recent years, the ability to generate activity and employment, its potential of innovation and international projection.

La Confederation Espagnole de la petite et moyenne entreprise (CEPYME) a sélectionné a Exagres comme l'une de 500 entreprises qui mènent la croissance entrepreneuriale tant par ses excellents résultats obtenus dans les dernières années, que pour sa capacité pour générer activité et emploi, son potentiel d'innovation et sa projection internationale.

Согласно исследованиям Испанской Конфедерации Малых и Средних Предприятий (CEPYME), Exagres вошла в рейтинг 500 быстрорастущих керамических производителей, как за результатами предыдущего года, так и способностью генерировать занятость, потенциал инноваций и международную деятельность.

MARBLE



# IMPERIAL

CHROMATIC VARIETY IN MARBLE  
IN&OUTDOOR  
LARGE FORMATS  
STAIRS  
SWIMMINGPOOLS



ES



EN

COLORS:	SIZES (cm):	SIZES (inches):
ARIAN	120x120 cm	47.2"x47.2"
CENIZA	60x120 cm	23.6"x47.2"
MOCA	60x60 cm	23.6"x23.6"
SIENA	14,5x120 cm	5.7"x47.2"
	33x66,5 cm	13.0"x26.2"



IMPERIAL CENIZA 60x120 CM (C-3) / 60x60 CM (C-1) - BORDE DESBORDANTE 28x66,5 CM (C-3) - ÁNGULO DESBORDANTE 31x31 CM (C-3)  
REJILLA 24,5x24,5 CM (C-3) - ÁNGULO REJILLA 24,5x33 CM (C-3)



# IMPERIAL / ARIAN



GRES EXTRUIDO · EXTRUDED KLINKER · GRÈS EXTRUDÉ · ЭКСТРУДИРОВАННЫЙ КЕРАМОГРАНИТ  
GRES PORCELÁNICO · PORCELAIN STONEWARE · GRÈS PORCELAINÉ · КЕРАМОГРАНИТ



R9 C-1 Alb <1,5% V2  
R11 C-3 CLASE C Bla <0,5%\*

FORMATOS · SIZES · FORMATS · ФОРМАТЫ

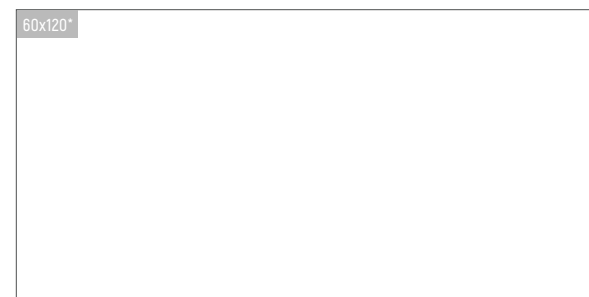
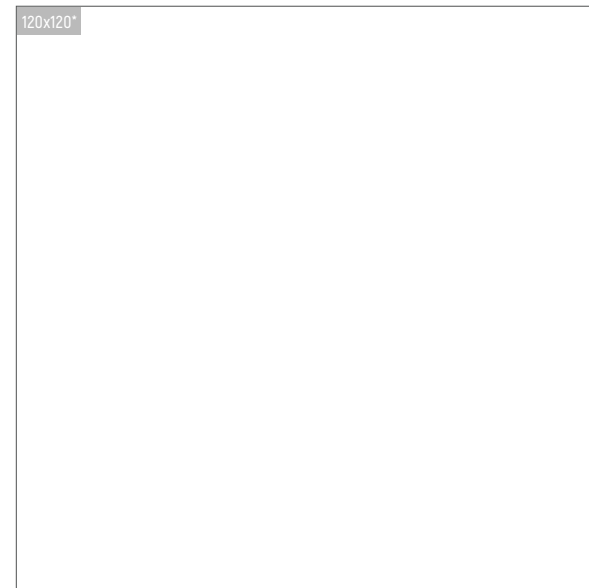

<b>120x120*</b> 120 x 120 cm - 47.2"x 47.2"	<b>60x120*</b> 60 x 120 cm - 23.6"x 47.2"	<b>14,5x120*</b> 14,5 x 120 cm - 5.7"x 47.2"
± 10 mm rectificado, rectified C-1/C-3	± 10 mm rectificado, rectified C-1/C-3	± 10 mm rectificado, rectified C-1

\* GRES PORCELÁNICO · PORCELAIN STONEWARE · GRÈS PORCELAINÉ · КЕРАМОГРАНИТ

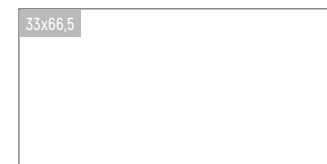
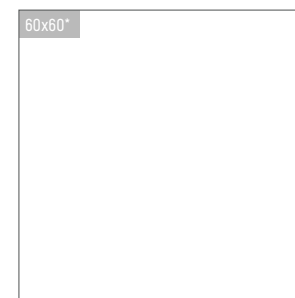

<b>60x60*</b> 60 x 60 cm - 23.6"x 23.6"	<b>33x66,5</b> 33 x 66,5 cm - 13.0"x 26.2"
± 9,4 mm rectificado, rectified C-1	± 10 mm C-1/C-3

PIEZAS ESPECIALES · SPECIAL PIECES · PIÈCES SPÉCIALES · СПЕЦИАЛЬНЫЕ ЭЛЕМЕНТЫ

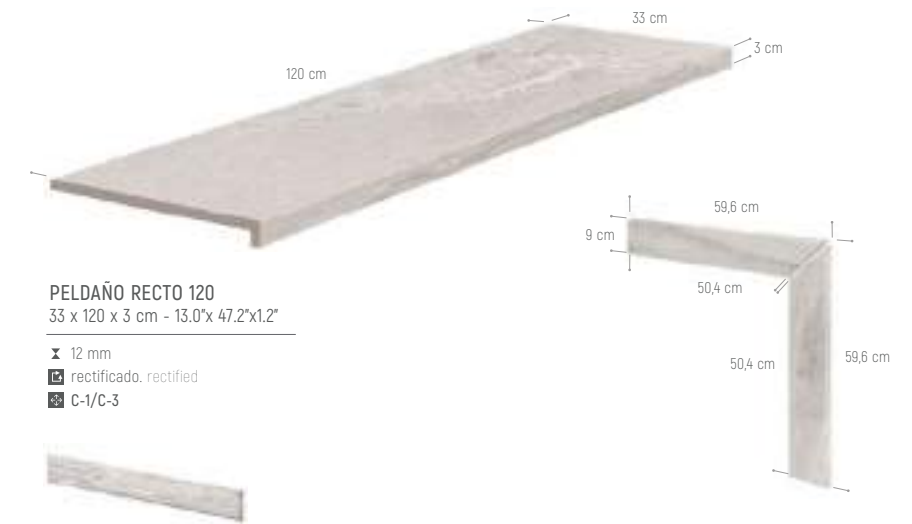

**PELDAÑO RECTO 120**  
33 x 120 x 3 cm - 13.0"x 47.2"x 1.2"  
± 12 mm  
rectificado, rectified  
C-1/C-3

**REMATE PELDAÑO RECTO**  
3 x 33 cm - 1.2"x 13.0"

**ZANQUÍN INGLETADO RECTO**  
59,6 x 59,6 cm - 23.5"x 23.5"  
± 11 mm



**PELDAÑO ML 120**  
33 x 120 x 4 cm - 13.0"x 47.2"x 1.6"  
± 13 mm  
rectificado, rectified  
C-1

**REMATE ML IZDA/DCHA**  
4 x 33 cm - 1.6"x 13.0"

**ZANQUÍN INGLETADO ML IZDA/DCHA**  
59,6 x 59,6 cm - 23.5"x 23.5"  
± 11 mm



**RODAPIÉ**  
9 x 60 cm - 3.6"x 23.6"  
± 11 mm

PIEZAS ESPECIALES · SPECIAL PIECES · PIÈCES SPÉCIALES · СПЕЦИАЛЬНЫЕ ЭЛЕМЕНТЫ



**BORDE SKIMMER**  
45 x 75 x 3 cm - 17.7" x 29.5" x 1.2"  
 rectificado, rectified  
 C-3

D. Continuidad gráfica, parte trasera.  
Digitally printed backside.



**BORDE DESBORDANTE**  
28 x 66,5 cm - 11.0" x 26.2"  
 rectificado, rectified  
 C-3



**ÁNGULO DESBORDANTE**  
31 x 31 cm - 12.2" x 12.2"  
 rectificado, rectified  
 C-3



**REJILLA**  
24,5 x 24,5 cm - 9.6" x 9.6"  
 rectificado, rectified  
 C-3



**ÁNGULO REJILLA IZDA/DCHA\***  
24,5 x 33 cm - 9.6" x 13.0"  
 rectificado, rectified  
 C-3

\*set de 2 piezas (izda./dcha.) \*two pieces set (left/right)



**MEDIA CAÑA**  
33 x 4 cm - 13.0" x 1.6"  
r-3 cm



**UÑA**  
4 x 4 cm  
1.6" x 1.6"



**ÁNGULO EXTERIOR ARISTA**  
5 x 5 cm  
2" x 2"



**ARISTA**  
33 x 3 cm - 13.0" x 1.2"  
r-3 cm



**UÑA ARISTA**  
3 x 3 cm  
1.2" x 1.2"



**ÁNGULO INTERIOR ARISTA**  
5 x 5 cm  
2" x 2"

IMPERIAL ARIAN 60x120 CM (C-3) - PELDAÑO RECTO 120 33x120x3 CM (C-1/C-3) - TABICA IMPERIAL ARIAN 14,5x120 CM - BORDE SKIMMER 45x75x3 CM (C-3)



# IMPERIAL / ARIAN



INDOOR: IMPERIAL ARIAN 120x120 CM [C-1] / 60x120 CM [C-1] - PELDAÑO RECTO 120 33x120x3 CM [C-1] - TABICA IMPERIAL ARIAN 14,5x120 CM - OROBICO TAUPE 60x120 CM [C-1]

OUTDOOR: IMPERIAL ARIAN 120x120 CM [C-3]



# IMPERIAL / ARIAN

INDOOR: IMPERIAL ARIAN 60x120 CM [C-1] - PELDAÑO ML 120 33x120x4 CM [C-1] - TABICA IMPERIAL ARIAN 14,5x120 CM



# IMPERIAL / CENIZA

GRES EXTRUIDO · EXTRUDED KLINKER · GRÈS EXTRUDÉ · ЭКСТРУДИРОВАННЫЙ КЕРАМОГРАНИТ  
GRES PORCELÁNICO · PORCELAIN STONEWARE · GRÈS PORCELAINÉ · КЕРАМОГРАНИТ



R9 C-1 Alb <1,5% V2  
R11 C-3 CLASE C Bla <0,5%\*

FORMATOS · SIZES · FORMATS · ФОРМАТЫ

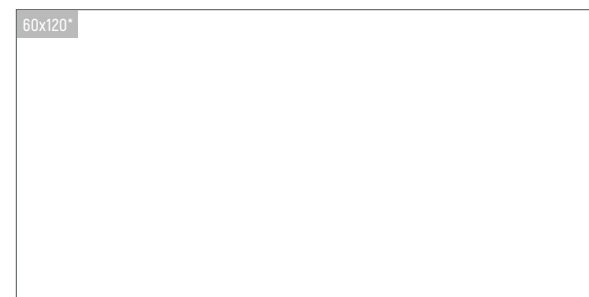
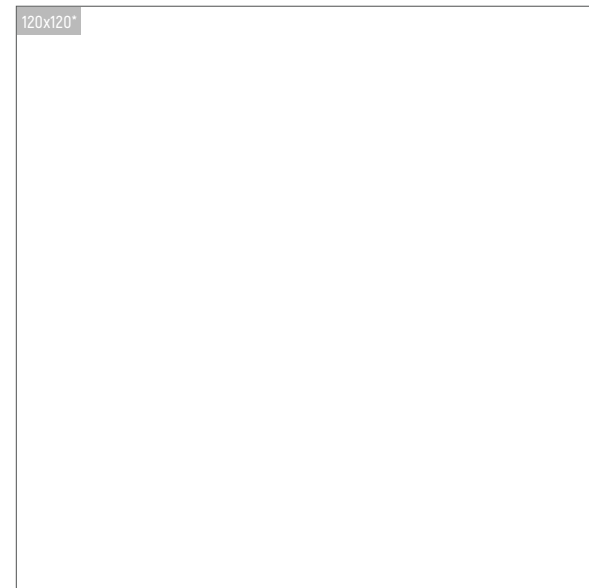

**120x120\***  
120 x 120 cm -  
47.2"x 47.2"

± 10 mm  
rectificado. rectified  
C-1/C-3

**60x120\***  
60 x 120 cm -  
23.6"x 47.2"

± 10 mm  
rectificado. rectified  
C-1/C-3

**14,5x120\***  
14,5 x 120 cm -  
5.7"x 47.2"

± 10 mm  
rectificado. rectified  
C-1

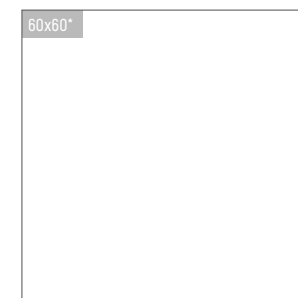

**60x60\***  
60 x 60 cm -  
23.6"x 23.6"

± 9,4 mm  
rectificado. rectified  
C-1

**33x66,5**  
33 x 66,5 cm -  
13.0"x 26.2"

± 10 mm  
C-1/C-3

PIEZAS ESPECIALES · SPECIAL PIECES · PIÈCES SPÉCIALES · СПЕЦИАЛЬНЫЕ ЭЛЕМЕНТЫ



**PELDAÑO RECTO 120**  
33 x 120 x 3 cm - 13.0"x 47.2"x 1.2"

± 12 mm  
rectificado. rectified  
C-1/C-3



**REMATE PELDAÑO RECTO**  
3 x 33 cm - 1.2"x 13.0"

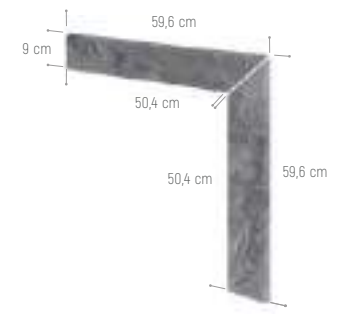

**ZANQUÍN INGLETADO RECTO**  
59,6 x 59,6 cm - 23.5"x 23.5"

± 11 mm



**PELDAÑO ML 120**  
33 x 120 x 4 cm - 13.0"x 47.2"x 1.6"

± 13 mm  
rectificado. rectified  
C-1



**REMATE ML IZDA/DCHA**  
4 x 33 cm - 1.6"x 13.0"



**ZANQUÍN INGLETADO ML IZDA/DCHA**  
59,6 x 59,6 cm - 23.5"x 23.5"

± 11 mm



**RODAPIÉ**  
9 x 60 cm - 3.6"x 23.6"

± 11 mm

\* GRES PORCELÁNICO · PORCELAIN STONEWARE · GRÈS PORCELAINÉ · КЕРАМОГРАНИТ

PIEZAS ESPECIALES · SPECIAL PIECES · PIÈCES SPÉCIALES · СПЕЦИАЛЬНЫЕ ЭЛЕМЕНТЫ

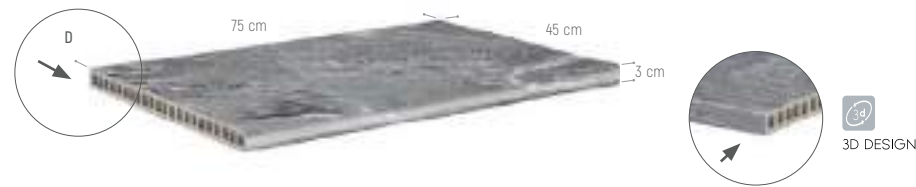

**BORDE SKIMMER**  
45 x 75 x 3 cm - 17.7"x 29.5"x1.2"  
 rectificado, rectified  
 C-3

D. Continuidad gráfica, parte trasera.  
Digitally printed backside.

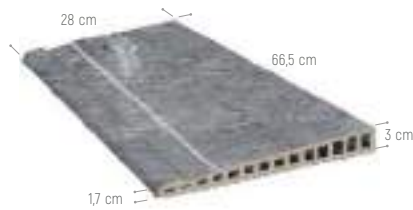

**BORDE DESBORDANTE**  
28 x 66,5 cm - 11.0"x26.2"  
 rectificado, rectified  
 C-3

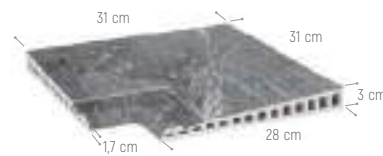

**ÁNGULO DESBORDANTE**  
31 x 31 cm - 12.2"x12.2"  
 rectificado, rectified  
 C-3



**REJILLA**  
24,5 x 24,5 cm - 9.6"x9.6"  
 rectificado, rectified  
 C-3



**ÁNGULO REJILLA IZDA/DCHA\***  
24,5 x 33 cm - 9.6"x13.0"  
 rectificado, rectified  
 C-3

\*set de 2 piezas (izda./dcha.) \*two pieces set (left/right)



**MEDIA CAÑA**  
33 x 4 cm - 13.0"x 1.6"  
r-3 cm



**UÑA**  
4 x 4 cm  
1.6"x 1.6"



**ÁNGULO EXTERIOR ARISTA**  
5 x 5 cm  
2"x 2"



**ARISTA**  
33 x 3 cm - 13.0"x 1.2"  
r-3 cm



**UÑA ARISTA**  
3 x 3 cm  
1.2"x 1.2"



**ÁNGULO INTERIOR ARISTA**  
5 x 5 cm  
2"x 2"

IMPERIAL CENIZA 60x120 CM [C-3] / 33x66,5 CM [C-3] - BORDE SKIMMER 45x75x3 CM [C-3] - PELDAÑO RECTO 120 33x120x3 CM [C-3] - TABICA IMPERIAL CENIZA 14,5x120 CM YOHO NATURAL 24,5x150 CM [C-3] - PELDAÑO RECTO 120 YOHO NATURAL 33x120x3 CM [C-3]



# IMPERIAL / CENIZA



OUTDOOR: IMPERIAL CENIZA 120x120 CM [C-3] - BORDE DESBORDANTE 28x66,5 CM [C-3] - REJILLA 24,5x24,5 CM [C-3]

INDOOR: IMPERIAL CENIZA 60x60 CM [C-1] - ÓPERA IVORY 60x120 CM [C-1]



# IMPERIAL / CENIZA

IMPERIAL CENIZA 60x120 CM (C-3) / 33x66,5 CM (C-3) - BORDE SKIMMER 45x75x3 CM (C-3) - PELDAÑO RECTO 120 33x120x3 CM (C-3) - TABICA IMPERIAL CENIZA 14,5x120 CM

YOHO NATURAL 24,5x150 CM (C-3) - PELDAÑO RECTO 120 YOHO NATURAL 33x120x3 CM (C-3)

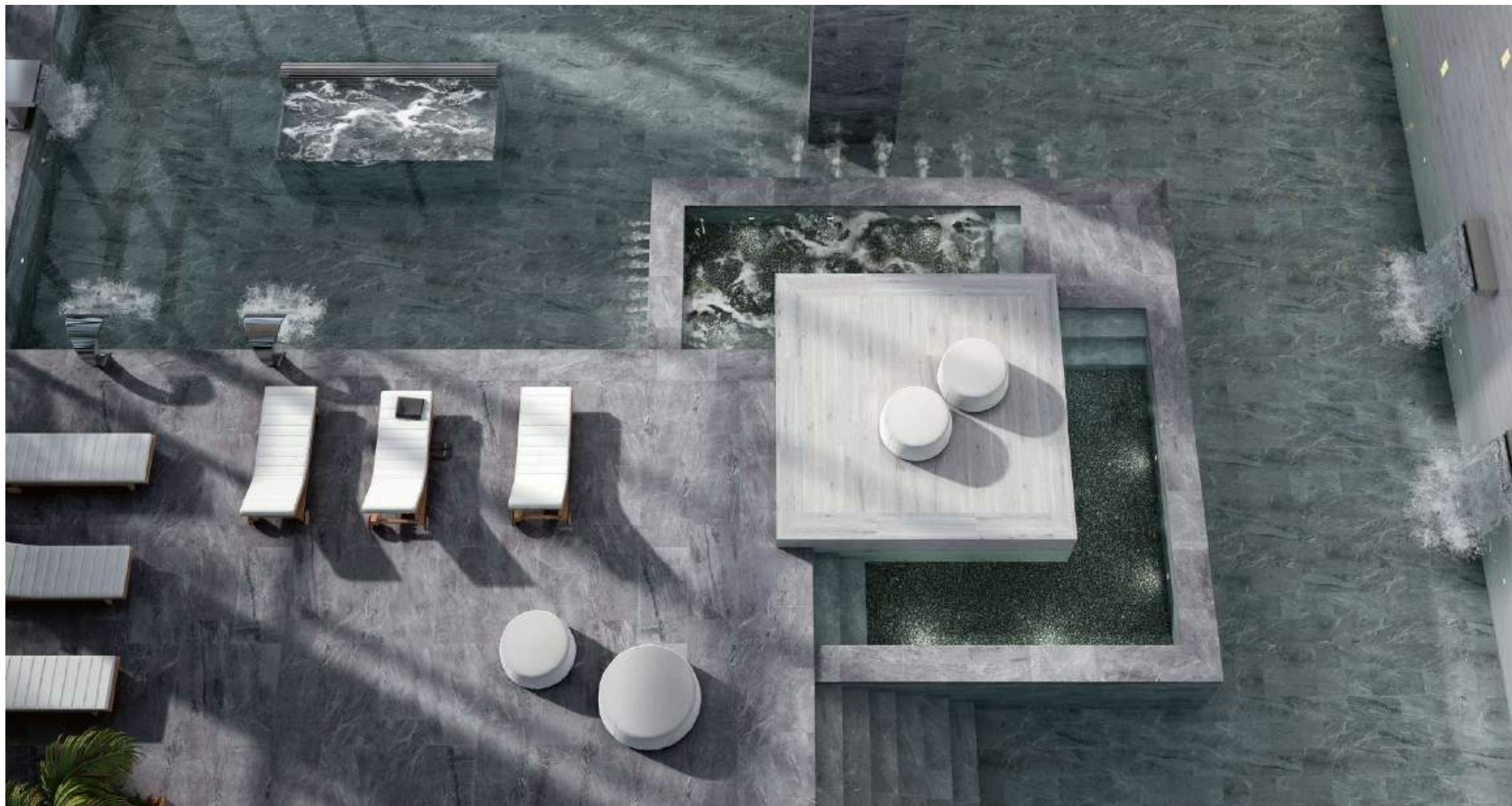



# IMPERIAL / MOCA

GRES EXTRUIDO · EXTRUDED KLINKER · GRÈS EXTRUDÉ · ЭКСТРУДИРОВАННЫЙ КЕРАМОГРАНИТ  
GRES PORCELÁNICO · PORCELAIN STONEWARE · GRÈS PORCELAINÉ · КЕРАМОГРАНИТ



R9 C-1 Alb <1,5% V2  
R11 C-3 CLASE C Bla <0,5%\*



FORMATOS · SIZES · FORMATS · ФОРМАТЫ

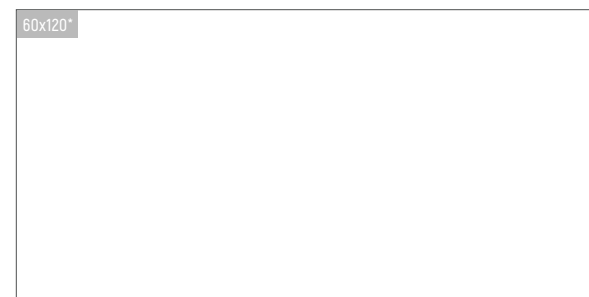
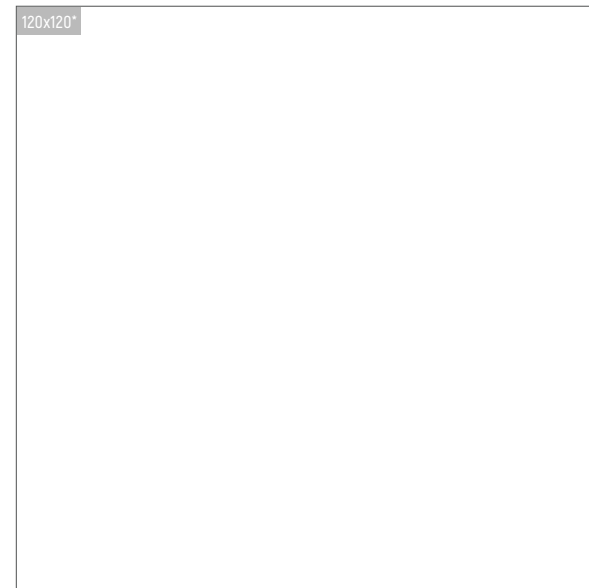

<b>120x120*</b> 120 x 120 cm - 47.2"x 47.2"	<b>60x120*</b> 60 x 120 cm - 23.6"x 47.2"	<b>14,5x120*</b> 14,5 x 120 cm - 5.7"x 47.2"
± 10 mm rectificado, rectified C-1/C-3	± 10 mm rectificado, rectified C-1/C-3	± 10 mm rectificado, rectified C-1

\* GRES PORCELÁNICO · PORCELAIN STONEWARE · GRÈS PORCELAINÉ · КЕРАМОГРАНИТ

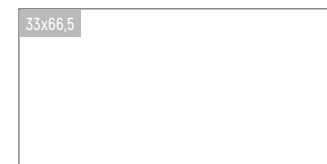
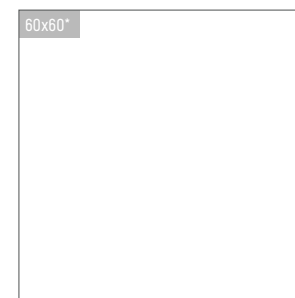

<b>60x60*</b> 60 x 60 cm - 23.6"x 23.6"	<b>33x66,5</b> 33 x 66,5 cm - 13.0"x 26.2"
± 9,4 mm rectificado, rectified C-1	± 10 mm C-1/C-3

PIEZAS ESPECIALES · SPECIAL PIECES · PIÈCES SPÉCIALES · СПЕЦИАЛЬНЫЕ ЭЛЕМЕНТЫ



**PELDAÑO RECTO 120**  
33 x 120 x 3 cm - 13.0"x 47.2"x 1.2"  
± 12 mm  
rectificado, rectified  
C-1/C-3



**REMATE PELDAÑO RECTO**  
3 x 33 cm - 1.2"x 13.0"



**ZANQUÍN INGLETADO RECTO**  
59,6 x 59,6 cm - 23.5"x 23.5"  
± 11 mm



**PELDAÑO ML 120**  
33 x 120 x 4 cm - 13.0"x 47.2"x 1.6"  
± 13 mm  
rectificado, rectified  
C-1



**REMATE ML IZDA/DCHA**  
4 x 33 cm - 1.6"x 13.0"

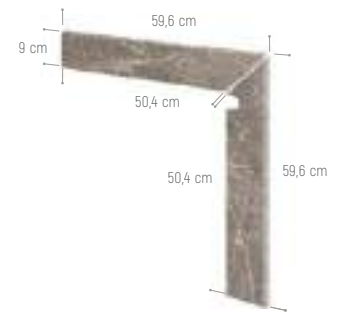

**ZANQUÍN INGLETADO ML IZDA/DCHA**  
59,6 x 59,6 cm - 23.5"x 23.5"  
± 11 mm



**RODAPIÉ**  
9 x 60 cm - 3.6"x 23.6"  
± 11 mm

PIEZAS ESPECIALES · SPECIAL PIECES · PIÈCES SPÉCIALES · СПЕЦИАЛЬНЫЕ ЭЛЕМЕНТЫ



**BORDE SKIMMER**  
45 x 75 x 3 cm - 17.7" x 29.5" x 1.2"  
 rectificado, rectified  
 C-3



**BORDE DESBORDANTE**  
28 x 66,5 cm - 11.0" x 26.2"  
 rectificado, rectified  
 C-3



**ÁNGULO DESBORDANTE**  
31 x 31 cm - 12.2" x 12.2"  
 rectificado, rectified  
 C-3



**REJILLA**  
24,5 x 24,5 cm - 9.6" x 9.6"  
 rectificado, rectified  
 C-3



**ÁNGULO REJILLA IZDA/DCHA\***  
24,5 x 33 cm - 9.6" x 13.0"  
 rectificado, rectified  
 C-3

\*set de 2 piezas (izda./dcha.) \*two pieces set (left/right)



**MEDIA CAÑA**  
33 x 4 cm - 13.0" x 1.6"  
 r-3 cm



**UÑA**  
4 x 4 cm  
 1.6" x 1.6"



**ÁNGULO EXTERIOR ARISTA**  
5 x 5 cm  
 2" x 2"



**ARISTA**  
33 x 3 cm - 13.0" x 1.2"  
 r-3 cm



**UÑA ARISTA**  
3 x 3 cm  
 1.2" x 1.2"



**ÁNGULO INTERIOR ARISTA**  
5 x 5 cm  
 2" x 2"

OUTDOOR: IMPERIAL MOCA 60x120 CM [C-3] - PELDAÑO RECTO 33x120x3 CM [C-3] - REMATE PELDAÑO RECTO 3x33 CM - TABICA 14,5x120 CM  
 BORDE DESBORDANTE 28x66,5 CM [C-3] - REJILLA 24,5x24,5 CM [C-3] - IMPERIAL MOCA 33x66,5 CM [C-1] - MEDIA CAÑA 33x4 CM - UÑA 4x4 CM

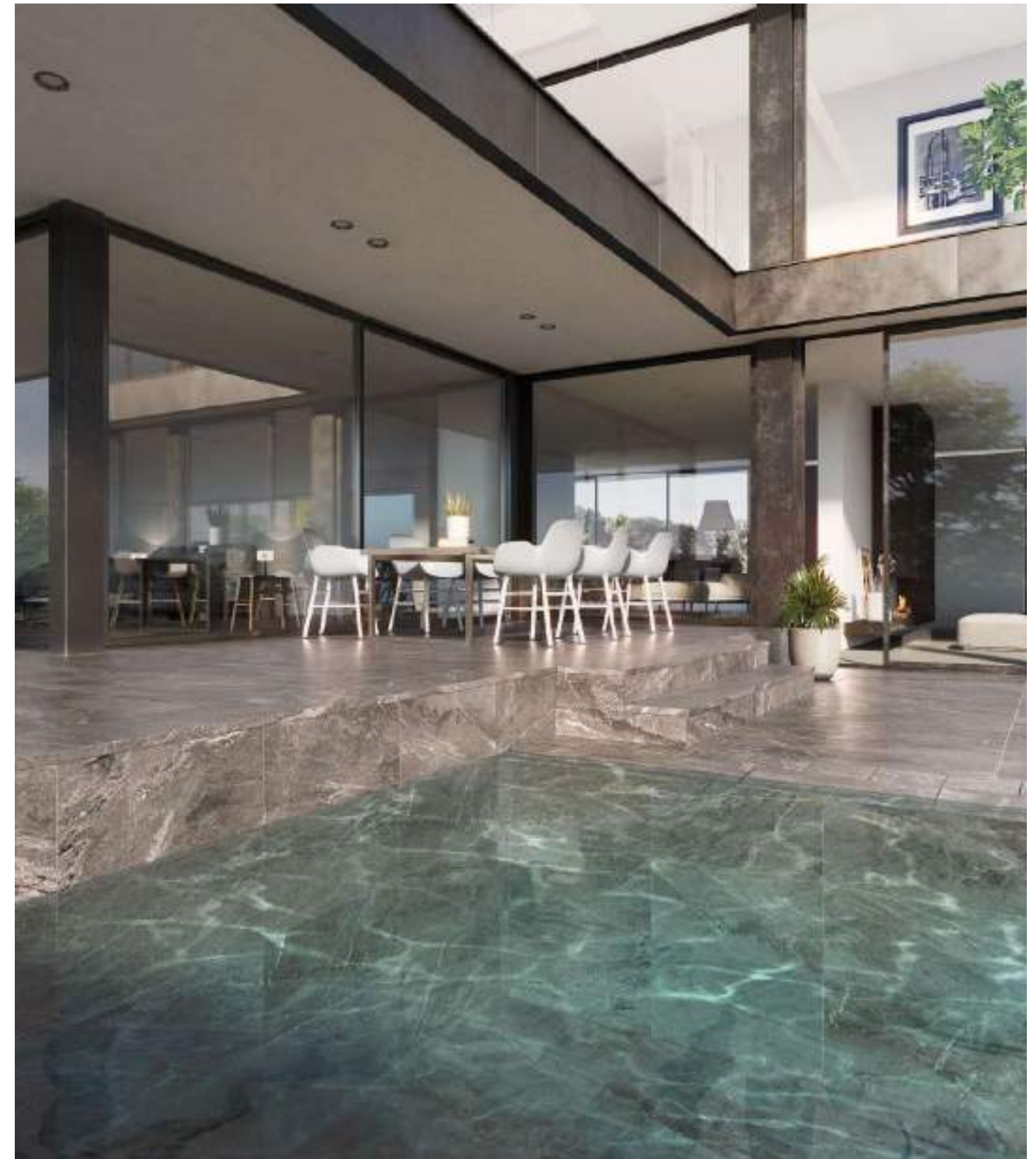

# IMPERIAL / MOCA



INDOOR: IMPERIAL MOCA 60x60 CM [C-1] - PELDAÑO ML 33x120x4 CM [C-1] - REMATE PELDAÑO ML 4x33 CM - TABICA 14,5x120 CM - ÓPERA IVORY 120x120 CM [C-1] / 60x120 CM [C-1] / 33x66,5 CM [C-1]

OUTDOOR: IMPERIAL MOCA 33x66,5 CM [C-3] - BORDE SKIMMER 45x75x3 CM [C-3] - IMPERIAL MOCA 33x66,5 CM [C-1]



# IMPERIAL / MOCA



OUTDOOR: IMPERIAL MOCA 60x120 CM [C-3] / 33x66,5 CM [C-1] - PELDAÑO RECTO 33x120x3 CM [C-3] - TABICA IMPERIAL MOCA 14,5x120 CM - BORDE DESBORDANTE 28x66,5 CM [C-3] -

REJILLA 24,5x24,5 CM [C-3]

INDOOR: IMPERIAL MOCA 60x120 CM [C-1]



# IMPERIAL / SIENA

GRES EXTRUIDO · EXTRUDED KLINKER · GRÈS EXTRUDÉ · ЭКСТРУДИРОВАННЫЙ КЕРАМОГРАНИТ  
GRES PORCELÁNICO · PORCELAIN STONEWARE · GRÈS PORCELAINÉ · КЕРАМОГРАНИТ



R9 C-1 Alb <1,5% V2  
R11 C-3 CLASE C Bla <0,5%\*

FORMATOS · SIZES · FORMATS · ФОРМАТЫ

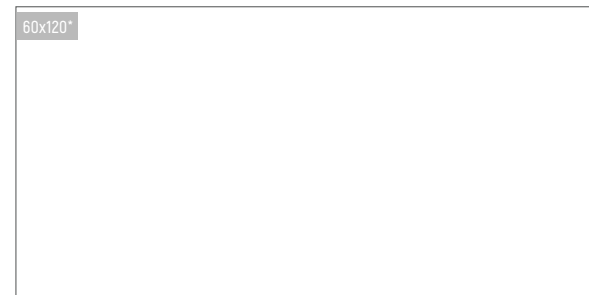
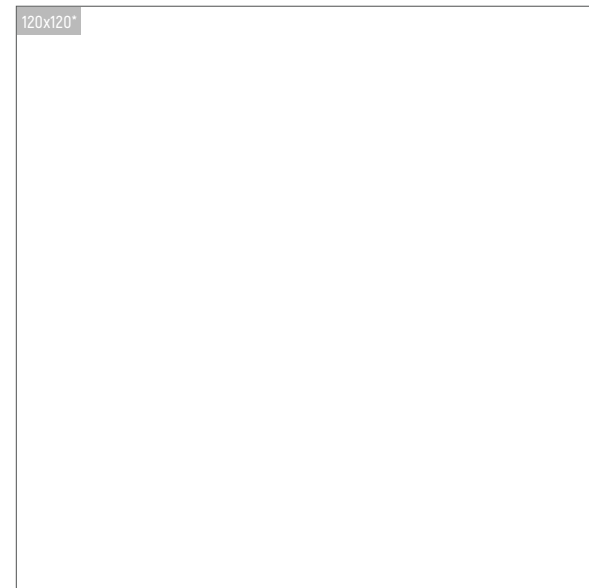

120x120\*  
120 x 120 cm -  
47.2"x 47.2"

± 10 mm  
rectificado, rectified  
C-1/C-3

60x120\*  
60 x 120 cm -  
23.6"x 47.2"

± 10 mm  
rectificado, rectified  
C-1/C-3

14,5x120\*  
14,5 x 120 cm -  
5.7"x 47.2"

± 10 mm  
rectificado, rectified  
C-1

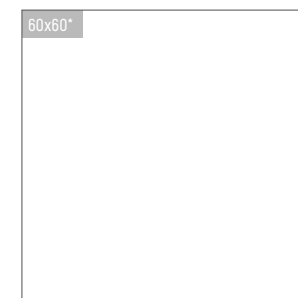

60x60\*  
60 x 60 cm -  
23.6"x 23.6"

± 9,4 mm  
rectificado, rectified  
C-1

33x66,5  
33 x 66,5 cm -  
13.0"x 26.2"

± 10 mm  
C-1/C-3

PIEZAS ESPECIALES · SPECIAL PIECES · PIÈCES SPÉCIALES · СПЕЦИАЛЬНЫЕ ЭЛЕМЕНТЫ



PELDAÑO RECTO 120  
33 x 120 x 3 cm - 13.0"x 47.2"x 1.2"

± 12 mm  
rectificado, rectified  
C-1/C-3



REMATE PELDAÑO RECTO  
3 x 33 cm - 1.2"x 13.0"



ZANQUÍN INGLETADO RECTO  
59,6 x 59,6 cm - 23.5"x 23.5"

± 11 mm



PELDAÑO ML 120  
33 x 120 x 4 cm - 13.0"x 47.2"x 1.6"

± 13 mm  
rectificado, rectified  
C-1



REMATE ML IZDA/DCHA  
4 x 33 cm - 1.6"x 13.0"



ZANQUÍN INGLETADO ML IZDA/DCHA  
59,6 x 59,6 cm - 23.5"x 23.5"

± 11 mm



RODAPIÉ  
9 x 60 cm - 3.6"x 23.6"

± 11 mm

\* GRES PORCELÁNICO · PORCELAIN STONEWARE · GRÈS PORCELAINÉ · КЕРАМОГРАНИТ

PIEZAS ESPECIALES · SPECIAL PIECES · PIÈCES SPÉCIALES · СПЕЦИАЛЬНЫЕ ЭЛЕМЕНТЫ



**BORDE SKIMMER**  
45 x 75 x 3 cm - 17.7" x 29.5" x 1.2"  
 rectificado, rectified  
 C-3



**BORDE DESBORDANTE**  
28 x 66,5 cm - 11.0" x 26.2"  
 rectificado, rectified  
 C-3



**ÁNGULO DESBORDANTE**  
31 x 31 cm - 12.2" x 12.2"  
 rectificado, rectified  
 C-3



**REJILLA**  
24,5 x 24,5 cm - 9.6" x 9.6"  
 rectificado, rectified  
 C-3



**ÁNGULO REJILLA IZDA/DCHA\***  
24,5 x 33 cm - 9.6" x 13.0"  
 rectificado, rectified  
 C-3

\*set de 2 piezas (izda/dcha.) \*two pieces set (left/right)



**MEDIA CAÑA**  
33 x 4 cm - 13.0" x 1.6"  
 r-3 cm



**UÑA**  
4 x 4 cm  
 1.6" x 1.6"



**ÁNGULO EXTERIOR ARISTA**  
5 x 5 cm  
 2" x 2"



**ARISTA**  
33 x 3 cm - 13.0" x 1.2"  
 r-3 cm



**UÑA ARISTA**  
3 x 3 cm  
 1.2" x 1.2"



**ÁNGULO INTERIOR ARISTA**  
5 x 5 cm  
 2" x 2"



# IMPERIAL / SIENA

IMPERIAL SIENA 120x120 CM [C-3] / 60x120 CM [C-1] / 33x66,5 CM [C-1] - PELDAÑO RECTO 120 33x120x3 CM [C-3] - TABICA 14,5x120 CM - BORDE SKIMMER 45x75x3 CM [C-3]

YOHO TECA 25x150 CM [C-3]



# IMPERIAL / SIENA

OUTDOOR: IMPERIAL SIENA 60x120 CM [C-3] - YOHO OAK 25x150 CM [C-3]

INDOOR: IMPERIAL SIENA 120x120 CM [C-1] - PELDAÑO RECTO 33x120x3 CM [C-3] - TABICA IMPERIAL SIENA 14,5x120 CM - OPERA IRON 120x120 CM [C-1]





MARBLE



# VENATTO

NEUTRAL AND CONTEMPORARY MARBLE  
IN&OUTDOOR  
STAIRS  
SWIMMINGPOOLS



ES



EN

COLORS:	SIZES (cm):	SIZES (inches):
PERLA	120x120 cm	47.2"x47.2"
	60x120 cm	23.6"x47.2"
	14,5x120 cm	5.7"x47.2"
	33x66,5 cm	13.0"x26.2"



INDOOR: VENATTO PERLA 120x120 CM [C-1]

OUTDOOR: VENATTO PERLA 120x120 CM [C-3] - PELDAÑO ML 33x120x4 CM [C-3]

# VENATTO / PERLA

exagres

TECHNICAL SOLUTIONS

GRES EXTRUIDO · EXTRUDED KLINKER · GRÈS EXTRUDÉ · ЭКСТРУДИРОВАННЫЙ КЕРАМОГРАНИТ  
 \*GRES PORCELÁNICO · PORCELAIN STONEWARE · GRÈS PORCELAINÉ · КЕРАМОГРАНИТ



R9 R11 C-1 C-3 CLASE C Alb <1.5% Bla <0.5% V1



## FORMATOS · SIZES · FORMATS · ФОРМАТЫ

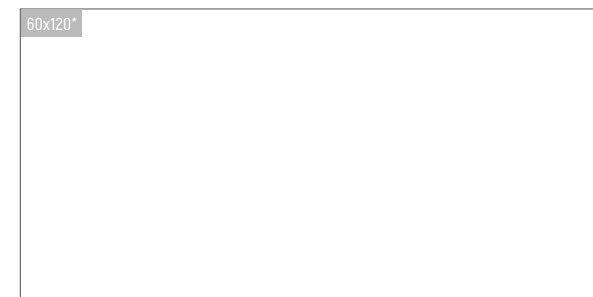
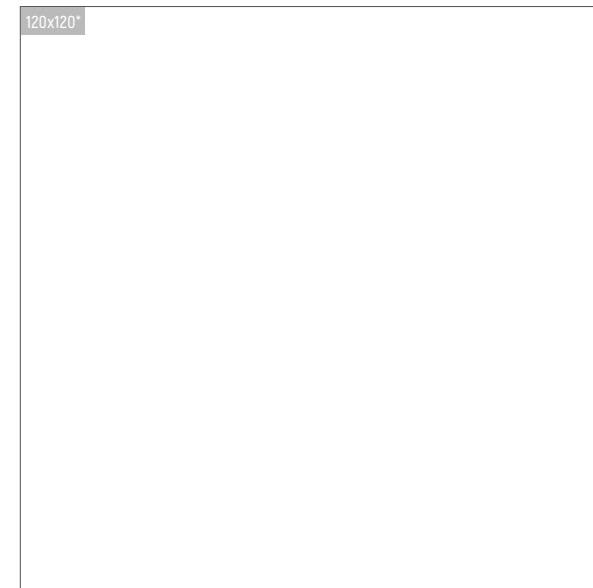

<b>120x120*</b> 120 x 120 cm - 47.2"x 47.2" 10 mm rectificado, rectified C-1/C-3	<b>60x120*</b> 60 x 120 cm - 23.6"x 47.2" 10 mm rectificado, rectified C-1/C-3	<b>14,5x120*</b> 14,5 x 120 cm - 5.7"x 47.2" 10 mm rectificado, rectified C-1	<b>33x66,5</b> 33 x 66,5 cm - 13.0"x 26.2" 10 mm rectificado, rectified C-1/C-3
--	--	---	---

## PIEZAS ESPECIALES · SPECIAL PIECES · PIÈCES SPÉCIALES · СПЕЦИАЛЬНЫЕ ЭЛЕМЕНТЫ

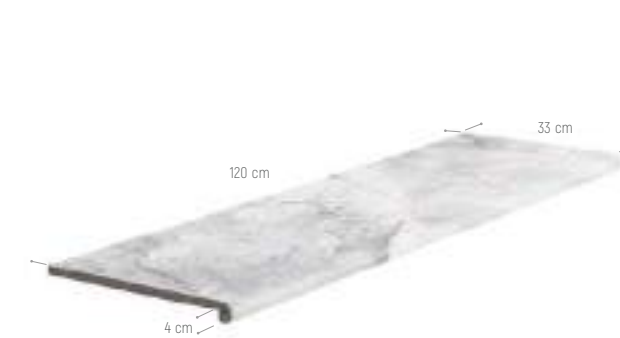

**PELDAÑO ML 120**  
 33 x 120 x 4 cm - 13.0"x 47.2"x 1.6"  
 13 mm  
 rectificado, rectified  
 C-1/C-3



**RODAPIÉ**  
 9 x 60 cm - 3.6"x 23.6"  
 11 mm

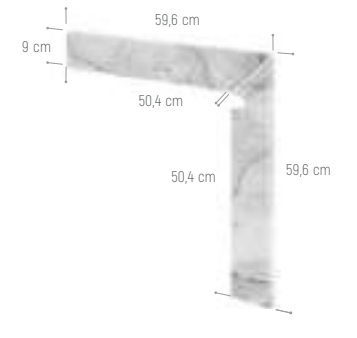

**ZANQUÍN INGLETADO ML IZDA/DCHA**  
 59,6 x 59,6 cm - 23.5"x 23.5"  
 11 mm



**BORDE SKIMMER**  
 45 x 75 x 3 cm - 17.7"x 29.5"x 1.2"  
 rectificado, rectified  
 C-3



D. Continuidad gráfica, parte trasera.  
 Graphic continuous, backside.



**BORDE DESBORDANTE**  
 28 x 66,5 cm - 11.0"x 26.2"  
 rectificado, rectified  
 C-3

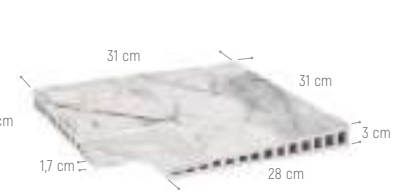

**ÁNGULO DESBORDANTE**  
 31 x 31 cm - 12.2"x 12.2"  
 rectificado, rectified  
 C-3



**REJILLA**  
 24,5 x 24,5 cm - 9.6"x 9.6"  
 rectificado, rectified  
 C-3



**ÁNGULO REJILLA IZDA/DCHA\***  
 24,5 x 33 cm - 9.6"x 13.0"  
 rectificado, rectified  
 C-3

\*set de 2 piezas (izda./dcha.) \*two pieces set (left/right)



**MEDIA CAÑA**  
 33 x 4 cm - 13.0"x 1.6"  
 r-3 cm



**UÑA**  
 4 x 4 cm  
 1.6"x 1.6"



**ÁNGULO EXTERIOR ARISTA**  
 5 x 5 cm  
 2"x 2"



**ARISTA**  
 33 x 3 cm - 13.0"x 1.2"  
 r-3 cm



**UÑA ARISTA**  
 3 x 3 cm  
 1.2"x 1.2"



**ÁNGULO INTERIOR ARISTA**  
 5 x 5 cm  
 2"x 2"

\*GRES PORCELÁNICO · PORCELAIN STONEWARE · GRÈS PORCELAINÉ · КЕРАМОГРАНИТ

# VENATTO / PERLA



OUTDOOR: VENATTO PERLA 60x120 CM [C-3] / 120x120 CM [C-3] - BORDE SKIMMER 45x75x3 CM [C-3]

WALL: OROBICO TAUPE 60x120 CM [C-1]

INDOOR: VENATTO PERLA 120x120 CM [C-1] - PELDAÑO ML 33x120x4 CM [C-1]



# VENATTO / PERLA



OUTDOOR: VENATTO PERLA 120x120 CM [C-3] - BORDE SKIMMER 45x75x3 CM [C-3] - VENATTO PERLA 33x66,5 CM [C-1] - MEDIA CAÑA 33x4 CM - UÑA 4x4 CM - PELDAÑO ML 33x120x4 CM [C-1]

WALL: OROBICO TAUPE 60x120 CM [C-1]



# VENATTO / PERLA

VENATTO PERLA 60x120 CM [C-1] - PELDAÑO ML 120 PERLA 33x120x4 CM [C-1] - TABICA VENATTO PERLA 14,5x120 CM [C-1]



# VENATTO / PERLA

VENATTO PERLA 120x120 CM [C-3] / 60x120 CM [C-1] - BORDE DESORDANTE 28x66,5 CM [C-3] - REJILLA 24,5x24,5 CM [C-3] - PELDAÑO ML 33x120x4 CM [C-3] -

YOHO TECA 25x150 CM [C-1 / C-3] - PELDAÑO RECTO 33x120x3 CM [C-3] - TABICA 14,5x120 CM



# VENATTO / PERLA

INDOOR: VENATTO PERLA 120x120 CM (C-1) - PELDAÑO ML 33x120x4 CM (C-1) - TABICA VENATTO PERLA 14,5x120 CM -

ÓPERA SILVER 60x120 CM (C-1)

OUTDOOR: VENATTO PERLA 120x120 CM (C-3)



MARBLE



# NUBIA

PURE BRUTALIST STYLE  
IN&OUTDOOR  
LARGE FORMATS  
STAIRS  
SWIMMINGPOOLS



ES



EN

COLORS:      SIZES (cm):      SIZES (inches):

NUBIA	60x120 cm 33x66,5 cm	23,6"x47.2" 13.0"x26.2"
-------	-------------------------	----------------------------



NUBIA 60x120 CM [C-1] - NUBIA 33x66,5 CM [C-1] - PELDAÑO RECTO 33x120x3 CM [C-3] - YOHO MAPLE 25x150 CM [C-3] - PELDAÑO RECTO 33x120x3 CM [C-3] - ÓPERA IVORY 120x120 CM [C-3] - BORDE DESBORDANTE 28x66,5 CM [C-3] - REJILLA 24,5x24,5 CM [C-3]



# NUBIA / NUBIA

GRES EXTRUIDO · EXTRUDED KLINKER · GRÈS EXTRUDÉ · ЭКСТРУДИРОВАННЫЙ КЕРАМОГРАНИТ  
GRES PORCELÁNICO · PORCELAIN STONEWARE · GRÈS PORCELAINÉ · КЕРАМОГРАНИТ



R9 C-1 Alb <1,5% V3  
R11 C-3 CLASE C Bla <0,5%\*



FORMATOS · SIZES · FORMATS · ФОРМАТЫ

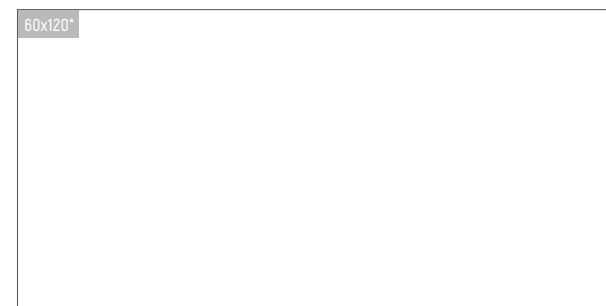

**60x120\***  
60 x 120 cm -  
23.6"x 47.2"

± 10 mm  
rectificado, rectified  
C-1/C-3

**33x66,5**  
33 x 66,5 cm -  
13.0"x 26.2"

± 10 mm  
C-1/C-3

\* GRES PORCELÁNICO · PORCELAIN STONEWARE · GRÈS PORCELAINÉ · КЕРАМОГРАНИТ

PIEZAS ESPECIALES · SPECIAL PIECES · PIÈCES SPÉCIALES · СПЕЦИАЛЬНЫЕ ЭЛЕМЕНТЫ



**PELDAÑO RECTO 120**  
33 x 120 x 3 cm - 13.0"x 47.2"x 1.2"

± 12 mm  
rectificado, rectified  
C-1/C-3



**MEDIA CAÑA**  
33 x 4 cm - 13.0"x 1.6"  
r-3 cm



**UÑA**  
4 x 4 cm - 1.6"x 1.6"



**ARISTA**  
33 x 3 cm - 13.0"x 1.2"  
r-3 cm



**UÑA ARISTA**  
3 x 3 cm - 1.2"x 1.2"

# NUBIA / NUBIA

exagres

TECHNICAL SOLUTIONS

OUTDOOR: NUBIA 60x120 CM [C-3]

INDOOR: NUBIA 60x120 CM [C-1] - YOHO MAPLE 25x150 CM [C-1]



# NUBIA / NUBIA

OUTDOOR: NUBIA 60x120 CM (C-1) - NUBIA 33x66,5 CM (C-1) - PELDAÑO RECTO 33x120x3 CM (C-3)

YOHO MAPLE 25x150 CM (C-3) - PELDAÑO RECTO 33x120x3 CM (C-3) - ÓPERA IVORY 120x120 CM (C-3) - BORDE DESBORDANTE 28x66,5 CM (C-3) - REJILLA 24,5x24,5 CM (C-3)



# NUBIA / NUBIA

INDOOR: NUBIA 60x120 CM [C-1] - PELDAÑO RECTO 33x120x3 CM [C-1] - TABICA 14,5x120 CM [C-1]

OUTDOOR: NUBIA 60x120 CM [C-3]



MARBLE

# OROBICO

DYNAMIC AND ELEGANT MARBLE  
INDOOR  
STAIRS



ES



EN

COLORS:      SIZES (cm):      SIZES (inches):

GRIS	60x120 cm	23.6"x47.2"
TAUPE	14,5x120 cm	5.7"x47.2"



OROBICO GRIS 60x120 CM [C-1] - PELDAÑO ML 33x120x4 CM [C-1] - TABICA OROBICO GRIS 14,5x120 CM [C-1] - RODAPIÉ 9x60 CM - ZANQUÍN ML 39,5x17,5 CM

# OROBICO / GRIS

GRES EXTRUIDO · EXTRUDED KLINKER · GRÈS EXTRUDÉ · ЭКСТРУДИРОВАННЫЙ КЕРАМОГРАНИТ  
GRES PORCELÁNICO · PORCELAIN STONEWARE · GRÈS PORCELAINÉ · КЕРАМОГРАНИТ

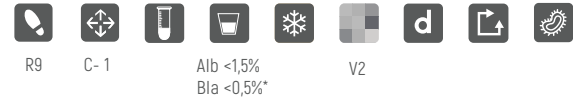

FORMATOS · SIZES · FORMATS · ФОРМАТЫ

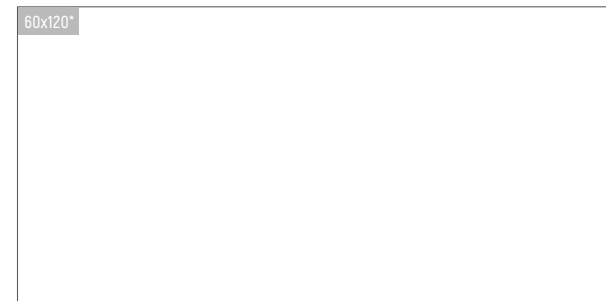

<p><b>60x120*</b> 60 x 120 cm - 23.6"x 47.2"</p> <p>± 10 mm rectificado, rectified C-1</p>	<p><b>14,5x120*</b> 14,5 x 120 cm - 5.7"x 47.2"</p> <p>± 10 mm rectificado, rectified C-1</p>
--	---

\* GRES PORCELÁNICO · PORCELAIN STONEWARE · GRÈS PORCELAINÉ · КЕРАМОГРАНИТ

PIEZAS ESPECIALES · SPECIAL PIECES · PIÈCES SPÉCIALES · СПЕЦИАЛЬНЫЕ ЭЛЕМЕНТЫ



**PELDAÑO ML 120**  
33 x 120 x 4 cm - 13.0"x 47.2"x 1.6"

± 13 mm  
rectificado, rectified  
C-1

**REMATE ML IZDA/DCHA**  
4 x 33 cm - 1.6"x 13.0"



**ZANQUÍN INGLETADO ML IZDA/DCHA**  
59,6 x 59,6 cm - 23.5"x 23.5"

± 11 mm



**RODAPIÉ**  
9 x 60 cm - 3,6"x 23.6"

± 11 mm

# OROBICO / GRIS

OROBICO GRIS 60x120 CM [C-1] - PELDAÑO ML 33x120x4 CM [C-1] - TABICA OROBICO GRIS 14,5x120 CM [C-1]



# OROBICO / TAUPE

GRES EXTRUIDO · EXTRUDED KLINKER · GRÈS EXTRUDÉ · ЭКСТРУДИРОВАННЫЙ КЕРАМОГРАНИТ  
 \*GRES PORCELÁNICO · PORCELAIN STONEWARE · GRÈS PORCELAINÉ · КЕРАМОГРАНИТ

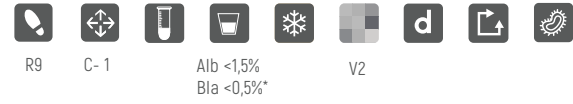

FORMATOS · SIZES · FORMATS · ФОРМАТЫ

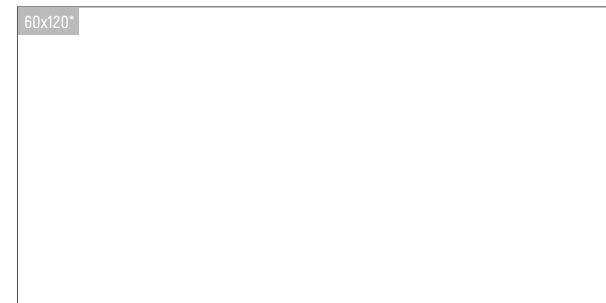

<p><b>60x120*</b> 60 x 120 cm - 23.6"x 47.2"</p> <p>± 10 mm   rectificado. rectified   C-1</p>	<p><b>14,5x120*</b> 14,5 x 120 cm - 5.7"x 47.2"</p> <p>± 10 mm   rectificado. rectified   C-1</p>
--	---

\*GRES PORCELÁNICO · PORCELAIN STONEWARE · GRÈS PORCELAINÉ · КЕРАМОГРАНИТ

PIEZAS ESPECIALES · SPECIAL PIECES · PIÈCES SPÉCIALES · СПЕЦИАЛЬНЫЕ ЭЛЕМЕНТЫ



**PELDAÑO ML 120**  
33 x 120 x 4 cm - 13.0"x 47.2"x 1.6"

± 13 mm  
 rectificado. rectified  
 C-1

**REMATE ML IZDA/DCHA**  
4 x 33 cm - 1.6"x 13.0"



**ZANQUÍN INGLETADO ML IZDA/DCHA**  
59,6 x 59,6 cm - 23.5"x 23.5"

± 11 mm



**RODAPIÉ**  
9 x 60 cm - 3,6"x 23.6"

± 11 mm



# OROBICO / TAUPE

OROBICO TAUPE 60x120 CM [C-1] - PELDAÑO ML 33x120x4 CM [C-1] - TABICA OROBICO TAUPE 14,5x120 CM [C-1] - REMATE ML 4x33 CM.



# OROBICO / TAUPE

OROBICO TAUPE 60x120 CM [C-1] - PELDAÑO ML 33x120x4 CM [C-1] - TABICA OROBICO TAUPE 14,5x120 CM [C-1] - REMATE ML 4x33 CM.



MARBLE



# MARBLES

ELEGANCE & TIMELESSNESS  
IN & OUTDOOR  
STAIRS  
SWIMMING POOLS



COLORS:	SIZES (cm):	SIZES (inches):
CALACATTA	60x120 cm	23.6"x47.2"
TRAVERTINO	14,5x120 cm	5.7"x47.2"
CREMA MARFIL	33x66,5 cm	13.0"x26.2"

TRAVERTINO 60x120 CM (C-1)

# MARBLES / CALACATTA



GRES EXTRUIDO · EXTRUDED KLINKER · GRÈS EXTRUDÉ · ЭКСТРУДИРОВАННЫЙ КЕРАМОГРАНИТ  
 \*GRES PORCELÁNICO · PORCELAIN STONEWARE · GRÈS PORCELAINÉ · КЕРАМОГРАНИТ



R9 C-1 Alb <1,5% V1  
 R11 C-3 CLASE C Bla <0,5%\*



FORMATOS · SIZES · FORMATS · ФОРМАТЫ

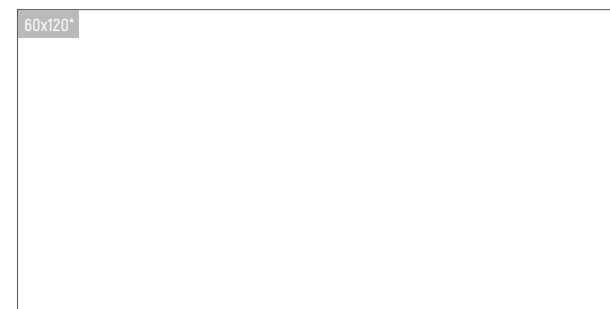

<b>60x120*</b> 60 x 120 cm - 23.6"x 47.2"	<b>14,5x120*</b> 14,5 x 120 cm - 5.7"x 47.2"	<b>33x66,5</b> 33 x 66,5 cm - 13.0"x 26.2"
± 10 mm rectificado, rectified C-1	± 10 mm rectificado, rectified C-1	± 10 mm C-1/C-3

PIEZAS ESPECIALES · SPECIAL PIECES · PIÈCES SPÉCIALES · СПЕЦИАЛЬНЫЕ ЭЛЕМЕНТЫ



**PELDAÑO RECTO 120**  
 33 x 120 x 3 cm - 13.0"x 47.2"x 1.2"  
 ± 12 mm  
 rectificado, rectified  
 C-3



**PELDAÑO FIORENTINO 120**  
 33 x 120 x 3 cm - 13.0"x 47.2"x 1.2"  
 ± 12 mm  
 rectificado, rectified  
 C-1

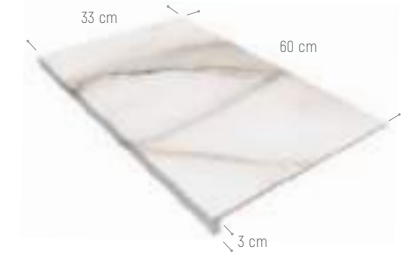

**PELDAÑO RECTO 60**  
 33 x 60 x 3 cm - 13.0"x 23.7"x 1.2"  
 ± 12 mm  
 rectificado, rectified  
 C-3



**REMATE PELDAÑO RECTO**  
 3 x 33 cm - 1.2"x 13.0"



**REMATE PELDAÑO FIORENTINO IZDA/DCHA**  
 3 x 33 cm - 1.2"x 13.0"



**ZANQUÍN RECTO**  
 40 x 18 cm - 15.7"x 7.1"  
 ± 15 mm



**ZANQUÍN FIORENTINO IZDA/DCHA**  
 40 x 18 cm - 15.7"x 7.1"  
 ± 15 mm



**RODAPIÉ**  
 9 x 40 cm - 3.5"x 15.7"  
 ± 15 mm



**MEDIA CAÑA**  
 33 x 4 cm - 13.0"x 1.6"  
 r-3 cm



**UÑA**  
 4 x 4 cm - 1.6"x 1.6"



**ARISTA**  
 33 x 3 cm - 13.0"x 1.2"  
 r-3 cm



**UÑA ARISTA**  
 3 x 3 cm - 1.2"x 1.2"

\*GRES PORCELÁNICO · PORCELAIN STONEWARE · GRÈS PORCELAINÉ · КЕРАМОГРАНИТ

# MARBLES / CALACATTA

OUTDOOR: MARBLES CALACATTA 33x66,5 CM [C-3] - PELDAÑO RECTO 33x60x3 CM [C-3]



OUTDOOR: MARBLES CALACATTA 33x66,5 CM [C-3] - PELDAÑO RECTO 33x60x3 CM [C-3] - MEDIA CAÑA 33x4 CM - UÑA 4x4 CM



# MARBLES / TRAVERTINO



GRES EXTRUIDO · EXTRUDED KLINKER · GRÈS EXTRUDÉ · ЭКСТРУДИРОВАННЫЙ КЕРАМОГРАНИТ  
 \*GRES PORCELÁNICO · PORCELAIN STONEWARE · GRÈS PORCELAINÉ · КЕРАМОГРАНИТ



FORMATOS · SIZES · FORMATS · ФОРМАТЫ

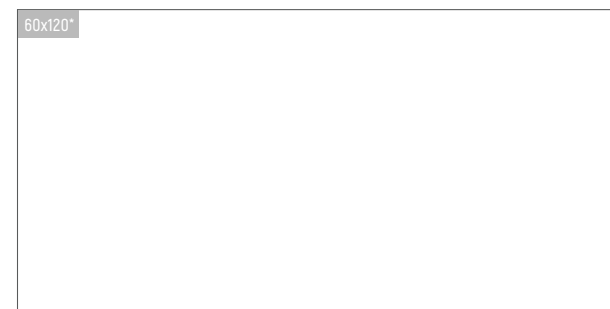

<b>60x120*</b> 60 x 120 cm - 23.6"x 47.2" 10 mm rectificado, rectified C-1	<b>14,5x120*</b> 14,5 x 120 cm - 5.7"x 47.2" 10 mm rectificado, rectified C-1	<b>33x66,5</b> 33 x 66,5 cm - 13.0"x 26.2" 10 mm rectificado, rectified C-1/C-3
--	---	---

PIEZAS ESPECIALES · SPECIAL PIECES · PIÈCES SPÉCIALES · СПЕЦИАЛЬНЫЕ ЭЛЕМЕНТЫ



**PELDAÑO RECTO 120**  
 33 x 120 x 3 cm - 13.0"x 47.2"x1.2"  
 12 mm  
 rectificado, rectified  
 C-3

**PELDAÑO FIORENTINO 120**  
 33 x 120 x 3 cm - 13.0"x 47.2"x1.2"  
 12 mm  
 rectificado, rectified  
 C-1

**PELDAÑO RECTO 60**  
 33 x 60 x 3 cm - 13.0"x 23.7"x1.2"  
 12 mm  
 rectificado, rectified  
 C-3



**REMATE PELDAÑO RECTO**  
 3 x 33 cm - 1.2"x 13.0"



**REMATE PELDAÑO FIORENTINO IZDA/DCHA**  
 3 x 33 cm - 1.2"x 13.0"



**ZANQUÍN RECTO**  
 40 x 18 cm - 15.7"x 7.1"  
 15 mm



**ZANQUÍN FIORENTINO IZDA/DCHA**  
 40 x 18 cm - 15.7"x 7.1"  
 15 mm



**RODAPIÉ**  
 9 x 40 cm - 3.5"x 15.7"  
 15 mm



**MEDIA CAÑA**  
 33 x 4 cm - 13.0"x 1.6"  
 r-3 cm



**UÑA**  
 4 x 4 cm - 1.6"x 1.6"



**ARISTA**  
 33 x 3 cm - 13.0"x 1.2"  
 r-3 cm



**UÑA ARISTA**  
 3 x 3 cm - 1.2"x 1.2"

\* GRES PORCELÁNICO · PORCELAIN STONEWARE · GRÈS PORCELAINÉ · КЕРАМОГРАНИТ

# MARBLES / CREMA MARFIL

GRES EXTRUIDO · EXTRUDED KLINKER · GRÈS EXTRUDÉ · ЭКСТРУДИРОВАННЫЙ КЕРАМОГРАНИТ  
GRES PORCELÁNICO · PORCELAIN STONEWARE · GRÈS PORCELAINÉ · КЕРАМОГРАНИТ



R9 C-1 Alb <1.5% V1  
R11 C-3 CLASE C Bla <0.5%\*



FORMATOS · SIZES · FORMATS · ФОРМАТЫ

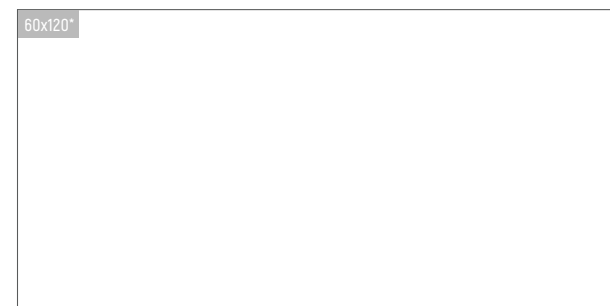

<b>60x120*</b> 60 x 120 cm - 23.6"x 47.2"	<b>14,5x120*</b> 14,5 x 120 cm - 5.7"x 47.2"	<b>33x66,5</b> 33 x 66,5 cm - 13.0"x 26.2"
10 mm rectificado, rectified C-1	10 mm rectificado, rectified C-1	10 mm C-1/C-3

PIEZAS ESPECIALES · SPECIAL PIECES · PIÈCES SPÉCIALES · СПЕЦИАЛЬНЫЕ ЭЛЕМЕНТЫ



**PELDAÑO RECTO 120**  
33 x 120 x 3 cm - 13.0"x 47.2"x 1.2"  
12 mm  
rectificado, rectified  
C-3



**REMATE PELDAÑO RECTO**  
3 x 33 cm - 1.2"x 13.0"



**PELDAÑO FIORENTINO 120**  
33 x 120 x 3 cm - 13.0"x 47.2"x 1.2"  
12 mm  
rectificado, rectified  
C-1



**REMATE PELDAÑO FIORENTINO IZDA/DCHA**  
3 x 33 cm - 1.2"x 13.0"



**PELDAÑO RECTO 60**  
33 x 60 x 3 cm - 13.0"x 23.7"x 1.2"  
12 mm  
rectificado, rectified  
C-3



**ZANQUÍN RECTO**  
40 x 18 cm - 15.7"x 7.1"  
15 mm



**ZANQUÍN FIORENTINO IZDA/DCHA**  
40 x 18 cm - 15.7"x 7.1"  
15 mm



**RODAPIÉ**  
9 x 40 cm - 3.5"x 15.7"  
15 mm



**MEDIA CAÑA**  
33 x 4 cm - 13.0"x 1.6"  
r-3 cm



**UÑA**  
4 x 4 cm - 1.6"x 1.6"



**ARISTA**  
33 x 3 cm - 13.0"x 1.2"  
r-3 cm



**UÑA ARISTA**  
3 x 3 cm - 1.2"x 1.2"

\* GRES PORCELÁNICO · PORCELAIN STONEWARE · GRÈS PORCELAINÉ · КЕРАМОГРАНИТ

# MARBLES / TRAVERTINO

OUTDOOR: TRAVERTINO 33x66,5 CM (C-3) - PELDAÑO RECTO 33x120x3 CM (C-3) / 33x60x3 CM (C-3) - TABICA 14,5x120 CM - MEDIA CAÑA 33x4 CM

FAÇADE: TRAVERTINO 33x66,5 CM (C-1)



# MARBLES / CREMA MARFIL

INDOOR: CREMA MARFIL 60x120 CM (C-1) - PELDAÑO RECTO 33x120x3 CM (C-3) - TABICA 14,5x120 CM





MARBLE

# MARKINA

MODERN GRAPHIC MARBLE  
LARGE FORMAT  
STAIRS  
SWIMMINGPOOLS



ES



EN



FR

COLORS:      SIZES (cm):      SIZES (inches):

BIANCO	62x120 cm	24.4"x47.2"
NERO	14,5x120 cm	5.7"x47.2"



MARKINA BIANCO 62x120 CM [C-3] - TABICA 14,5x120 CM [C-1] - PELDAÑO RECTO 35x120x3 CM [C-3]

# MARKINA / BIANCO

GRES EXTRUIDO · EXTRUDED KLINKER · GRÈS EXTRUDÉ · ЭКСТРУДИРОВАННЫЙ КЕРАМОГРАНИТ  
GRES PORCELÁNICO · PORCELAIN STONEWARE · GRÈS PORCELAINÉ · КЕРАМОГРАНИТ



R9 C-1 Alb <1,5% V1  
R11 C-3 Bla <0,5%

FORMATOS · SIZES · FORMATS · ФОРМАТЫ

PIEZAS ESPECIALES · SPECIAL PIECES · PIÈCES SPÉCIALES · СПЕЦИАЛЬНЫЕ ЭЛЕМЕНТЫ

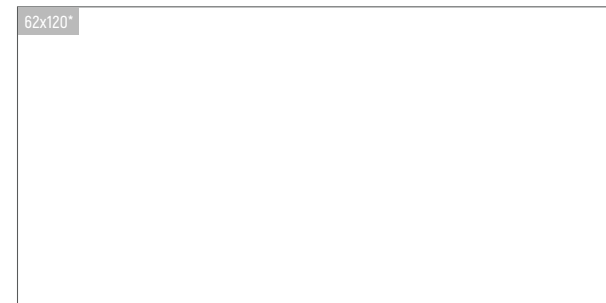
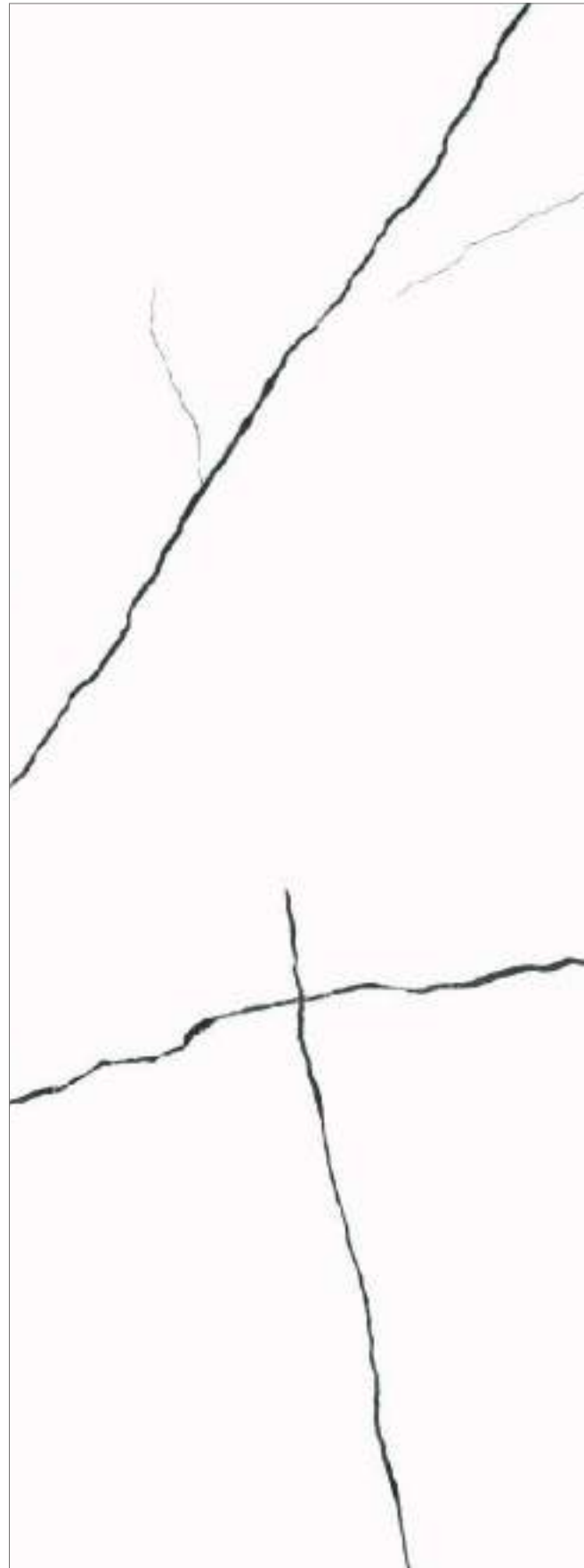

<b>62x120*</b> 62 x 120 cm - 24.4"x 47.2"	<b>14,5x120*</b> 14,5 x 120 cm - 5.7"x 47.2"
± 11 mm	± 11 mm
rectificado, rectified	rectificado, rectified
C-1/C-3	C-1

\* GRES PORCELÁNICO · PORCELAIN STONEWARE · GRÈS PORCELAINÉ · КЕРАМОГРАНИТ



**PELDAÑO RECTO 120**  
33 x 120 x 3 cm - 13.0"x 47.2"x 1.2"

± 12 mm  
rectificado, rectified  
C-1/C-3



**REMATE PELDAÑO RECTO**  
3 x 33 cm - 1.2"x 13.0"



**ZANQUÍN RECTO**  
40 x 18 cm - 15.7"x 7.1"

± 15 mm



**RODAPIÉ**  
9 x 40 cm - 3.5"x 15.7"

± 15 mm

# MARKINA / BIANCO



OUTDOOR: MARKINA BIANCO 62x120 CM [C-3] - PELDAÑO RECTO 120 - 33x120x3 CM [C-3]

INDOOR: MARKINA BIANCO 62x120 CM [C-1]



# MARKINA / NERO

GRES EXTRUIDO · EXTRUDED KLINKER · GRÈS EXTRUDÉ · ЭКСТРУДИРОВАННЫЙ КЕРАМОГРАНИТ  
 GRES PORCELÁNICO · PORCELAIN STONEWARE · GRÈS PORCELAINÉ · КЕРАМОГРАНИТ

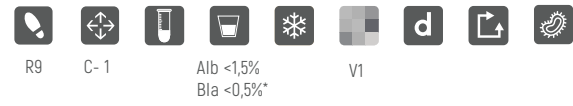

FORMATOS · SIZES · FORMATS · ФОРМАТЫ

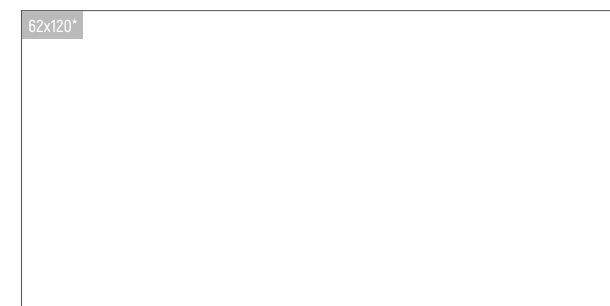

**62x120\***  
 62 x 120 cm - 24.4" x 47.2"  
 11 mm  
 rectificado, rectified  
 C-1

**14,5x120\***  
 14,5 x 120 cm - 5.7" x 47.2"  
 11 mm  
 rectificado, rectified  
 C-1

\* GRES PORCELÁNICO · PORCELAIN STONEWARE · GRÈS PORCELAINÉ · КЕРАМОГРАНИТ

PIEZAS ESPECIALES · SPECIAL PIECES · PIÈCES SPÉCIALES · СПЕЦИАЛЬНЫЕ ЭЛЕМЕНТЫ



**PELDAÑO RECTO 120**  
 33 x 120 x 3 cm - 13.0" x 47.2" x 1.2"  
 12 mm  
 rectificado, rectified  
 C-1



**REMATE PELDAÑO RECTO**  
 3 x 33 cm - 1.2" x 13.0"



**ZANQUÍN RECTO**  
 40 x 18 cm - 15.7" x 7.1"  
 15 mm



**RODAPIÉ**  
 9 x 40 cm - 3.5" x 15.7"  
 15 mm

# MARKINA / NERO

exagres

TECHNICAL SOLUTIONS

MARKINA NERO 62x120 CM [C-1] - PELDAÑO RECTO 33x120 CM [C-1] - TABICA 14,5x120 CM



# MARKINA / NERO

exagres

TECHNICAL SOLUTIONS

MARKINA NERO 62x120 CM [C-1] - PELDAÑO RECTO 33x120x3 CM [C-1] - TABICA 14,5x120 CM - LIZANA NOGAL 25x150 CM [C-1]



WOOD



# LIZANA

COLOURFUL AND VERSATILE WOOD  
IN&OUTDOOR  
STAIRS  
SWIMMINGPOOLS



ES



EN



FR

COLORS:	SIZES (cm):	SIZES (inches):
HAYA	25x150 cm	9.8"x59.0"
CEREZO	20x120 cm	7.9"x47.2"
OLIVO	14,5x120 cm	5.7"x47.2"
NOGAL	16,25x66,5 cm	6.4"x26.2"



OUTDOOR: LIZANA HAYA 16,25x66,5 CM [C-3] - REJILLA 24,5x66,5 CM [C-3] - ÁNG. REJILLA IZDA/DCHA 24,5x33 CM [C-3] - BORDE DESBORDANTE 28x66,5 CM [C-3] - ÁNG. DESBORDANTE 31x31 CM [C-3] INDOOR: LIZANA HAYA 25x150 CM [C-1]

# LIZANA / HAYA

exagres  
TECHNICAL SOLUTIONS

GRES EXTRUIDO · EXTRUDED KLINKER · GRÈS EXTRUDÉ · ЭКСТРУДИРОВАННЫЙ КЕРАМОГРАНИТ  
GRES PORCELÁNICO · PORCELAIN STONEWARE · GRÈS PORCELAINÉ · КЕРАМОГРАНИТ



R9 C-1 Alb <1,5% V1  
R12 C-3 CLASE C Bla <0,5%\*

FORMATOS · SIZES · FORMATS · ФОРМАТЫ

PIEZAS ESPECIALES · SPECIAL PIECES · PIÈCES SPÉCIALES · СПЕЦИАЛЬНЫЕ ЭЛЕМЕНТЫ



25x150*	20x120*	14,5x120*	16,25x66,5
25x150* 25 x 150 cm - 9.8"x 59.0"	20x120* 20 x 120 cm - 7.9"x 47.2"	14,5x120* 14,5 x 120 cm - 5.7"x 47.2"	16,25x66,5 16,25 x 66,5 cm - 6.4"x 26.2"
<ul style="list-style-type: none"> <li>9 mm</li> <li>rectificado, rectified</li> <li>C-1/C-3</li> </ul>	<ul style="list-style-type: none"> <li>9 mm</li> <li>rectificado, rectified</li> <li>C-1/C-3</li> </ul>	<ul style="list-style-type: none"> <li>10,1 mm</li> <li>rectificado, rectified</li> <li>C-1</li> </ul>	<ul style="list-style-type: none"> <li>10 mm</li> <li>C-3</li> </ul>

\* GRES PORCELÁNICO · PORCELAIN STONEWARE · GRÈS PORCELAINÉ · КЕРАМОГРАНИТ

<p><b>PELDAÑO RECTO 120</b> 33 x 120 x 3 cm - 13.0"x 47.2"x 1.2"</p> <ul style="list-style-type: none"> <li>12 mm</li> <li>rectificado, rectified</li> <li>C-1/C-3</li> </ul>	<p><b>REMATE PELDAÑO RECTO</b> 3 x 33 cm - 1.2"x 13.0"</p>	<p><b>ZANQUÍN INGLETADO RECTO</b> 59,6 x 59,6 cm - 23.5"x 23.5"</p> <ul style="list-style-type: none"> <li>11 mm</li> </ul>
<p><b>PELDAÑO ML 150</b> 33 x 150 x 4 cm - 13.0"x 59.1"x 1.6"</p> <ul style="list-style-type: none"> <li>13 mm</li> <li>rectificado, rectified</li> <li>C-1/C-3</li> </ul>	<p><b>REMATE ML IZDA/DCHA</b> 4 x 33 cm - 1.6"x 13.0"</p>	<p><b>ZANQUÍN INGLETADO ML IZDA/DCHA</b> 59,6 x 59,6 cm - 23.5"x 23.5"</p> <ul style="list-style-type: none"> <li>11 mm</li> </ul>
<p><b>BORDE DESBORDANTE</b> 28 x 66,5 cm - 11.0"x 26.2"</p> <ul style="list-style-type: none"> <li>rectificado, rectified</li> <li>C-3</li> </ul>	<p><b>ÁNGULO DESBORDANTE</b> 31 x 31 cm - 12.2"x 12.2"</p> <ul style="list-style-type: none"> <li>rectificado, rectified</li> <li>C-3</li> </ul>	
<p><b>REJILLA</b> 24,5 x 66,5 cm - 9.6"x 26.2"</p> <ul style="list-style-type: none"> <li>rectificado, rectified</li> <li>C-3</li> </ul>	<p><b>ÁNGULO REJILLA IZDA/DCHA*</b> 24,5 x 33 cm - 9.6"x 13.0"</p> <ul style="list-style-type: none"> <li>rectificado, rectified</li> <li>C-3</li> </ul> <p>*set de 2 piezas (izda/dcha) *two pieces set (left/right)</p>	<p><b>RODAPIÉ</b> 9 x 60 cm - 3.6"x 23.6"</p> <ul style="list-style-type: none"> <li>11 mm</li> </ul>



# LIZANA / HAYA

exagres

TECHNICAL SOLUTIONS

INDOOR: LIZANA HAYA 20x120 CM (C-1) - PELDAÑO RECTO 120 - 33x120x2 CM (C-1)

OUTDOOR: LIZANA HAYA 25x150 CM (C-3) - PELDAÑO ML 150 - 33x150x4 CM (C-3)



# LIZANA / HAYA



OUTDOOR: LIZANA HAYA 25x150 CM [C-3] - PELDAÑO ML 150 33x150x4 CM [C-3]

INDOOR: LIZANA HAYA 20x120 CM [C-1]



# LIZANA / HAYA

exagres

TECHNICAL SOLUTIONS

INDOOR: LIZANA HAYA 20x120 CM (C-1) - PELDAÑO RECTO 120 - 33x120x3 CM (C-1) - TABICA 14,5x120 CM - COSMOS STEEL 120x120 CM (C-1)



# LIZANA / HAYA

exagres

TECHNICAL SOLUTIONS

OUTDOOR: LIZANA HAYA 16,25x66,5 CM [C-3] - REJILLA 24,5x66,5 CM [C-3] - ÁNG. REJILLA IZDA/DCHA 24,5x33 CM [C-3] - BORDE DESBORDANTE 28x66,5 CM [C-3] - ÁNG. DESBORDANTE 31x31 CM [C-3]

INDOOR: LIZANA HAYA 25x120 CM [C-1]



# LIZANA / CEREZO

exagres  
TECHNICAL SOLUTIONS





GRES EXTRUIDO · EXTRUDED KLINKER · GRÈS EXTRUDÉ · ЭКСТРУДИРОВАННЫЙ КЕРАМОГРАНИТ  
GRES PORCELÁNICO · PORCELAIN STONEWARE · GRÈS PORCELAINÉ · КЕРАМОГРАНИТ



R9 R12 C-1 C-3 CLASE C Alb <1.5% Bla <0.5%\* V1













FORMATOS · SIZES · FORMATS · ФОРМАТЫ

 <p><b>25x150*</b> 25 x 150 cm - 9.8"x 59.0"</p> <p>± 9 mm rectificado. rectified C-1/C-3</p>	 <p><b>20x120*</b> 20 x 120 cm - 7.9"x 47.2"</p> <p>± 9 mm rectificado. rectified C-1/C-3</p>	 <p><b>14,5x120*</b> 14,5 x 120 cm - 5.7"x 47.2"</p> <p>± 10,1 mm rectificado. rectified C-1</p>	 <p><b>16,25x66,5</b> 16,25 x 66,5 cm - 6.4"x 26.2"</p> <p>± 10 mm C-3</p>
---	---	---	---

\* GRES PORCELÁNICO · PORCELAIN STONEWARE · GRÈS PORCELAINÉ · КЕРАМОГРАНИТ

PIEZAS ESPECIALES · SPECIAL PIECES · PIÈCES SPÉCIALES · СПЕЦИАЛЬНЫЕ ЭЛЕМЕНТЫ

 <p><b>PELDAÑO RECTO 120</b> 33 x 120 x 3 cm - 13.0"x 47.2"x 1.2"</p> <p>± 12 mm rectificado. rectified C-1/C-3</p>	 <p><b>REMATE PELDAÑO RECTO</b> 3 x 33 cm - 1.2"x 13.0"</p>	 <p><b>ZANQUÍN INGLETADO RECTO</b> 59,6 x 59,6 cm - 23.5"x 23.5"</p> <p>± 11 mm</p>
 <p><b>PELDAÑO ML 150</b> 33 x 150 x 4 cm - 13.0"x 59.1"x 1.6"</p> <p>± 13 mm rectificado. rectified C-1/C-3</p>	 <p><b>REMATE ML IZDA/DCHA</b> 4 x 33 cm - 1.6"x 13.0"</p>	 <p><b>ZANQUÍN INGLETADO ML IZDA/DCHA</b> 59,6 x 59,6 cm - 23.5"x 23.5"</p> <p>± 11 mm</p>
 <p><b>BORDE DESBORDANTE</b> 28 x 66,5 cm - 11.0"x 26.2"</p> <p>rectificado. rectified C-3</p>	 <p><b>ÁNGULO DESBORDANTE</b> 31 x 31 cm - 12.2"x 12.2"</p> <p>rectificado. rectified C-3</p>	
 <p><b>REJILLA</b> 24,5 x 66,5 cm - 9.6"x 26.2"</p> <p>rectificado. rectified C-3</p>	 <p><b>ÁNGULO REJILLA IZDA/DCHA*</b> 24,5 x 33 cm - 9.6"x 13.0"</p> <p>rectificado. rectified C-3</p> <p>*set de 2 piezas (izda/dcha) *two pieces set (left/right)</p>	 <p><b>RODAPIÉ</b> 9 x 60 cm - 3.6"x 23.6"</p> <p>± 11 mm</p>

# LIZANA / CEREZO

exagres

TECHNICAL SOLUTIONS

OUTDOOR: LIZANA CEREZO 16,25x66,5 CM (C-3)

INDOOR: LIZANA CEREZO 25x150 CM (C-1) - PELDAÑO RECTO 120 - 33x120x3 CM (C-1) - TABICA 14,5x120 CM (C-1) - REMATE PELDAÑO RECTO 3x33 CM



# LIZANA / CEREZO

OUTDOOR: LIZANA CEREZO 25x150 CM [C-3] - REJILLA 24,5x66,5 CM [C-3] - ÁNGULO REJILLA IZDA/DCHA 24,5x33 CM [C-3] - BORDE DESBORDANTE 28x66,5 CM [C-3] -

ÁNGULO DESBORDANTE 31x31 CM [C-3] - ÓPERA SILVER 60x120 CM [C-3] - PELDAÑO RECTO 33x120x3 CM [C-3] - TABICA 14,5x120 CM [C-1]



# LIZANA / CEREZO

LIZANA CEREZO 25x150 CM (C-1) - LIZANA CEREZO 20x120 CM (C-1) - PELDAÑO ML 150 - 33x150x4 CM (C-1)





# LIZANA / OLIVO

exagres  
TECHNICAL SOLUTIONS

GRES EXTRUIDO · EXTRUDED KLINKER · GRÈS EXTRUDÉ · ЭКСТРУДИРОВАННЫЙ КЕРАМОГРАНИТ  
GRES PORCELÁNICO · PORCELAIN STONEWARE · GRÈS PORCELAINÉ · КЕРАМОГРАНИТ



R9 C-1 Alb <1,5% V1  
R12 C-3 CLASE C Bla <0,5%\*

FORMATOS · SIZES · FORMATS · ФОРМАТЫ

PIEZAS ESPECIALES · SPECIAL PIECES · PIÈCES SPÉCIALES · СПЕЦИАЛЬНЫЕ ЭЛЕМЕНТЫ

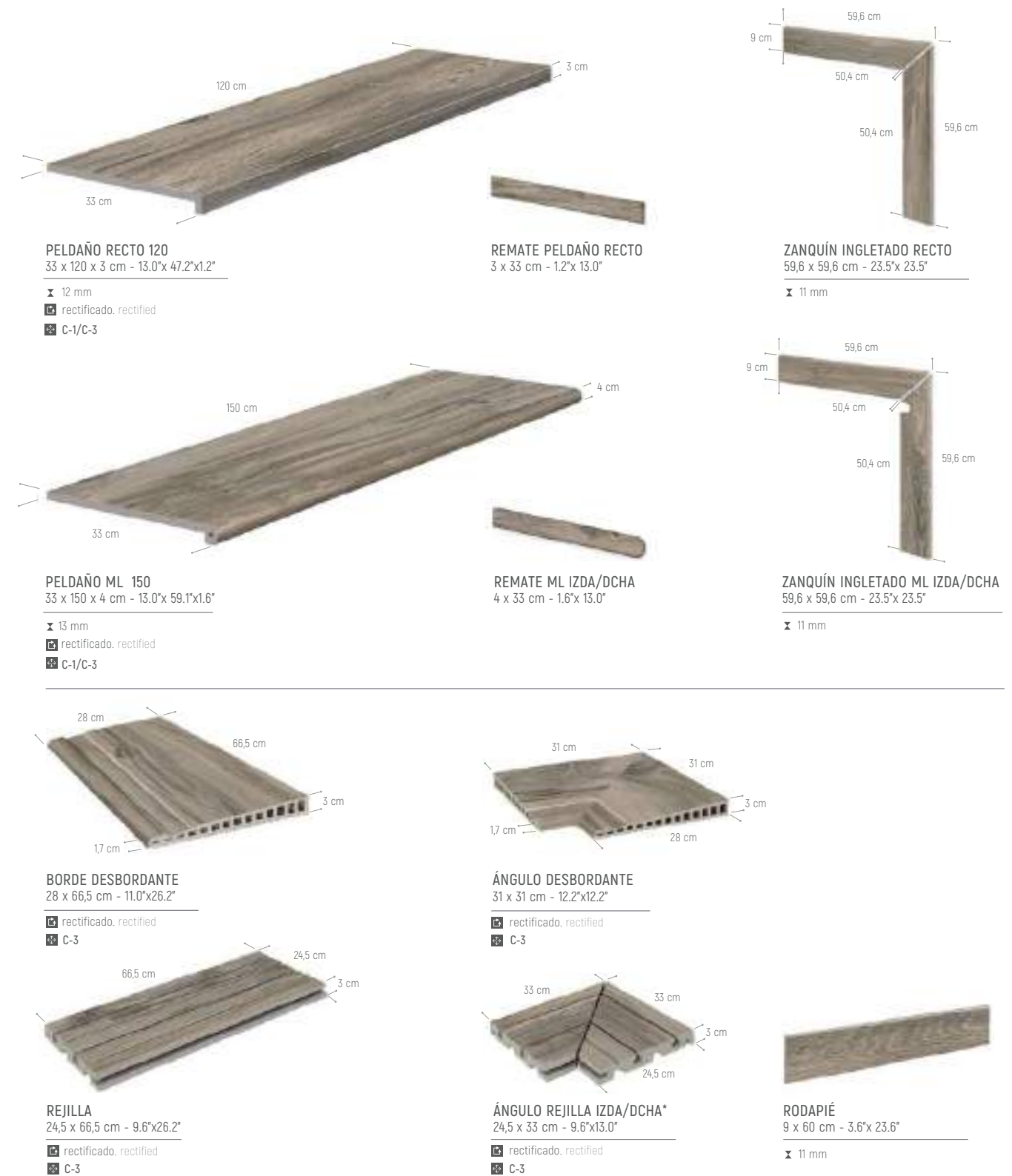
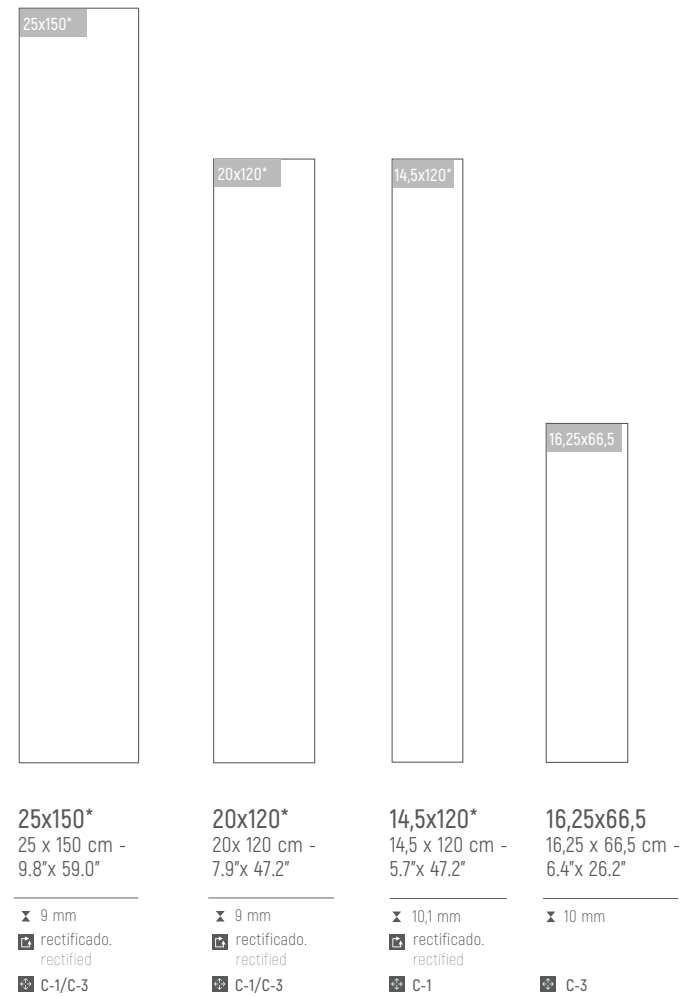

\* GRES PORCELÁNICO · PORCELAIN STONEWARE · GRÈS PORCELAINÉ · КЕРАМОГРАНИТ

\*set de 2 piezas (izda/dcha) \*two pieces set (left/right)

# LIZANA / OLIVO



INDOOR: LIZANA OLIVO 16,25x66,5 CM [C-3] - BORDE DESBORDANTE 28x66,5 CM [C-3] - ÁNGULO DESBORDANTE 31x31 CM [C-3] - REJILLA 24,5x66,5 CM [C-3]

ÁNGULO REJILLA IZDA/DCHA REJILLA 24,5x33 CM [C-3] -COSMOS VENUS 60x120 CM [C-1]

OUTDOOR: LIZANA OLIVO 16,25x66,5 CM [C-3]



# LIZANA / OLIVO

exagres

TECHNICAL SOLUTIONS

OUTDOOR: LIZANA OLIVO 20x120 CM [C-3] - PELDAÑO RECTO 120 - 33x120x3 CM [C-3] - TABICA 14,5x120 CM - COSMOS CORTEN 60x120 CM [C-1]

INDOOR: COSMOS CORTEN 120x120 CM [C-1]



# LIZANA / OLIVO

exagres

TECHNICAL SOLUTIONS

OUTDOOR: LIZANA OLIVO 25x150 CM (C-3)

INDOOR: LIZANA OLIVO 25x150 CM (C-1) - PELDAÑO ML 150 · 33x150x4 CM (C-1)



# LIZANA / NOGAL

exagres  
TECHNICAL SOLUTIONS

GRES EXTRUIDO · EXTRUDED KLINKER · GRÈS EXTRUDÉ · ЭКСТРУДИРОВАННЫЙ КЕРАМОГРАНИТ  
GRES PORCELÁNICO · PORCELAIN STONEWARE · GRÈS PORCELAINÉ · КЕРАМОГРАНИТ



R9 C-1 Alb <1,5% V1  
R12 C-3 CLASE C Bla <0,5%\*

FORMATOS · SIZES · FORMATS · ФОРМАТЫ

PIEZAS ESPECIALES · SPECIAL PIECES · PIÈCES SPÉCIALES · СПЕЦИАЛЬНЫЕ ЭЛЕМЕНТЫ

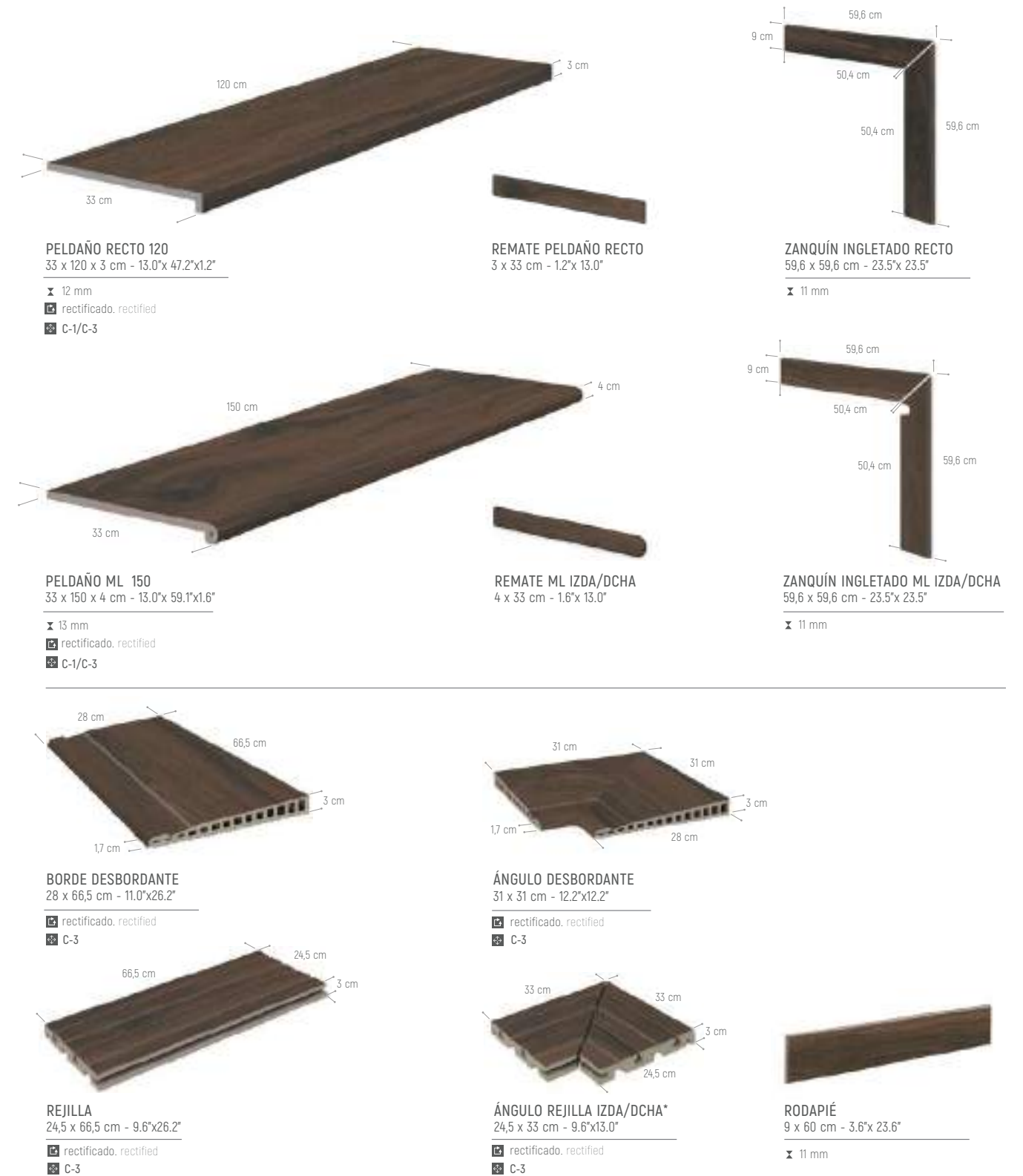
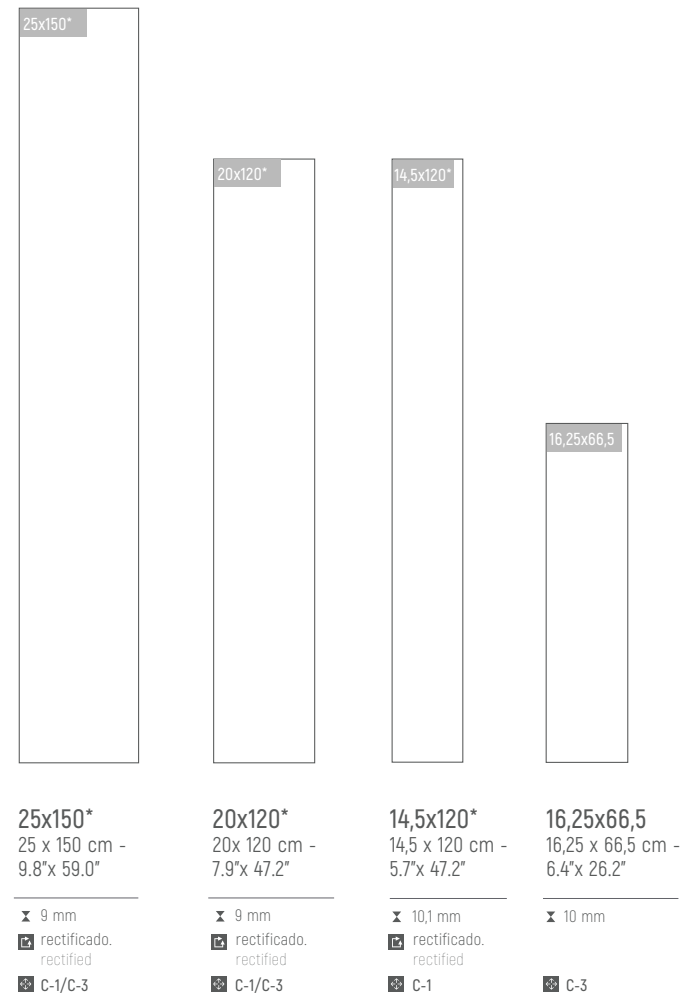

\* GRES PORCELÁNICO · PORCELAIN STONEWARE · GRÈS PORCELAINÉ · КЕРАМОГРАНИТ

# LIZANA / NOGAL

LIZANA NOGAL 25x120 CM [C-1] - PELDAÑO ML 150 33x150x4 CM [C-1] - RODAPIÉ 9x60 CM - ZANQUÍN INGLETADO ML IZDA/DCHA



# LIZANA / NOGAL

exagres  
TECHNICAL SOLUTIONS

INDOOR: ARDENAS MARFIL 60x120 CM (C-1)

OUTDOOR: LIZANA NOGAL 20x120 CM (C-3) - PELDAÑO ML 150 - 33x150x4 CM (C-3) - PELDAÑO RECTO 120 33x120x3 CM (C-3) - TABICA 14,5x120 CM

ARDENAS MARFIL 60x120 CM (C-3) - PELDAÑO RECTO 33x120x3 CM (C-3) - TABICA 14,5x120 CM - IMPERIAL SIENA 33x66,5 CM (C-1)



# LIZANA / NOGAL

INDOOR: LIZANA NOGAL 25x150 CM [C-1] - PELDAÑO RECTO 120 33x120x3 CM [C-1] - TABICA 14,5x120 CM [C-1] - RODAPIÉ 9x60 CM





WOOD



# YOHO

NATURAL WOOD ESSENCE  
IN&OUTDOOR  
STAIRS  
SWIMMINGPOOLS



ES / EN

COLORS:	SIZES (cm):	SIZES (inches):
NATURAL	25x150 cm	9.8"x59.0"
MAPLE	14,5x120 cm	5.7"x47.2"
OAK	16,25x66,5 cm	6.4"x26.2"
TECA		



INDOOR: YOHO NATURAL 24,5x150 CM [C-1]

OUTDOOR: YOHO NATURAL 16,25x66,5 CM [C-3] - BORDE SKIMMER 45x75x3 cm [C-3]

# YOHO / NATURAL

GRES EXTRUIDO · EXTRUDED KLINKER · GRÈS EXTRUDÉ · ЭКСТРУДИРОВАННЫЙ КЕРАМОГРАНИТ  
GRES PORCELÁNICO · PORCELAIN STONEWARE · GRÈS PORCELAINÉ · КЕРАМОГРАНИТ





R9 C-1 Alb <1.5% V1  
R11 C-3 CLASE C Bla <0.5%\*

FORMATOS · SIZES · FORMATS · ФОРМАТЫ

PIEZAS ESPECIALES · SPECIAL PIECES · PIÈCES SPÉCIALES · СПЕЦИАЛЬНЫЕ ЭЛЕМЕНТЫ

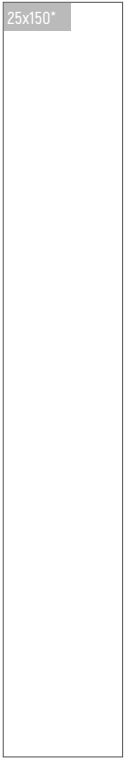

 <p><b>25x150*</b> 25 x 150 cm - 9.8"x 59.0"</p> <p>± 9 mm rectificado, rectified C-1/C-3</p>	 <p><b>14,5x120*</b> 14,5 x 120 cm - 5.7"x 47.2"</p> <p>± 10,1 mm rectificado, rectified C-1</p>	 <p><b>16,25x66,5</b> 16,25 x 66,5 cm - 6.4"x 26.2"</p> <p>± 10 mm C-3</p>
--	---	---

 <p><b>PELDAÑO RECTO 120</b> 33 x 120 x 3 cm - 13.0"x 47.2"x 1.2"</p> <p>± 12 mm rectificado, rectified C-1/C-3</p>	 <p><b>REMATE PELDAÑO RECTO</b> 3 x 33 cm - 1.2"x 13.0"</p>
 <p><b>ZANQUÍN INGLETADO RECTO</b> 59,6 x 59,6 cm - 23.5"x 23.5"</p> <p>± 11 mm</p>	 <p><b>RODAPIÉ</b> 9 x 60 cm - 3.6"x 23.6"</p> <p>± 11 mm</p>
 <p><b>BORDE SKIMMER</b> 45 x 75 x 3 cm - 17.7"x 29.5"x 1.2"</p> <p>rectificado, rectified C-3</p>	

 3D DESIGN  
 D. Continuidad gráfica, parte trasera.  
 Digitally printed backside.

\* GRES PORCELÁNICO · PORCELAIN STONEWARE · GRÈS PORCELAINÉ · КЕРАМОГРАНИТ

# YOHO / NATURAL

YOHO NATURAL 24,5x150 CM [C-3] - PELDAÑO RECTO 120 33x120x3 CM [C-3] - TABICA YOHO NATURAL 14,5x120 CM



YOHO NATURAL 24,5x150 CM [C-3] - BORDE SKIMMER 45x75x3 CM [C-3]

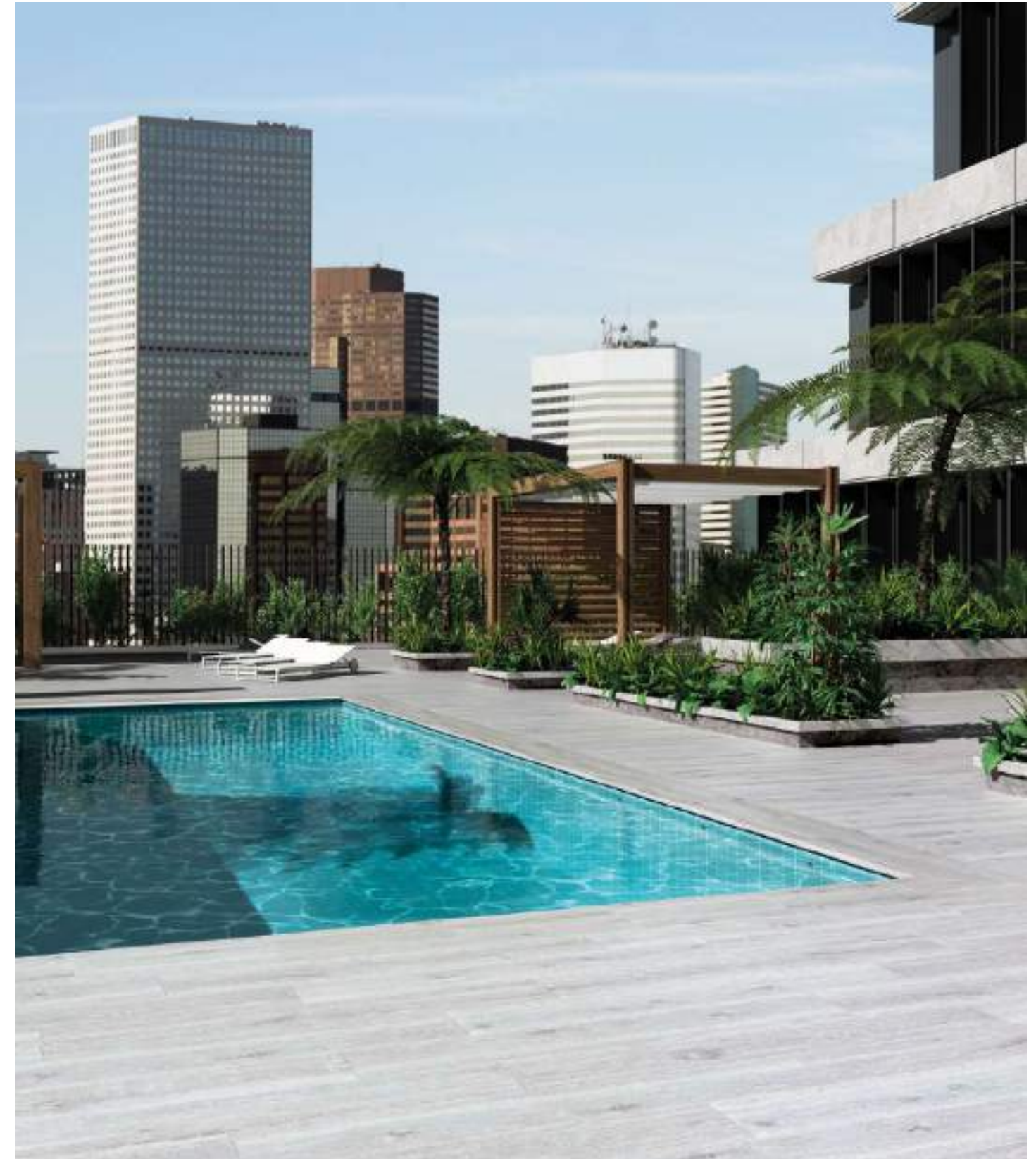

# YOHO / MAPLE

GRES EXTRUIDO · EXTRUDED KLINKER · GRÈS EXTRUDÉ · ЭКСТРУДИРОВАННЫЙ КЕРАМОГРАНИТ  
GRES PORCELÁNICO · PORCELAIN STONEWARE · GRÈS PORCELAINÉ · КЕРАМОГРАНИТ











R9 C-1 Alb <1,5% V1  
R11 C-3 CLASE C Bla <0,5%\*

FORMATOS · SIZES · FORMATS · ФОРМАТЫ

PIEZAS ESPECIALES · SPECIAL PIECES · PIÈCES SPÉCIALES · СПЕЦИАЛЬНЫЕ ЭЛЕМЕНТЫ



 <p><b>25x150*</b> 25 x 150 cm - 9.8"x 59.0"</p> <p>± 9 mm rectificado, rectified C-1/C-3</p>	 <p><b>14,5x120*</b> 14,5 x 120 cm - 5.7"x 47.2"</p> <p>± 10,1 mm rectificado, rectified C-1</p>	 <p><b>16,25x66,5</b> 16,25 x 66,5 cm - 6.4"x 26.2"</p> <p>± 10 mm C-3</p>
--	---	---

 <p><b>PELDAÑO RECTO 120</b> 33 x 120 x 3 cm - 13.0"x 47.2"x 1.2"</p> <p>± 12 mm rectificado, rectified C-1/C-3</p>	 <p><b>REMATE PELDAÑO RECTO</b> 3 x 33 cm - 1.2"x 13.0"</p>
 <p><b>ZANQUÍN RECTO IZDA/DCHA</b> 42,3 x 17,5 cm - 16.7"x 6.9"</p> <p>± 7,5 mm</p>	 <p><b>RODAPIÉ</b> 9 x 60 cm - 3.6"x 23.6"</p> <p>± 11 mm</p>
 <p><b>BORDE SKIMMER</b> 45 x 75 x 3 cm - 17.7"x 29.5"x 1.2"</p> <p>rectificado, rectified C-3</p>	 <p><b>3D DESIGN</b> D. Continuidad gráfica, parte trasera. Digitally printed backside.</p>

\* GRES PORCELÁNICO · PORCELAIN STONEWARE · GRÈS PORCELAINÉ · КЕРАМОГРАНИТ

# YOHO / MAPLE



INDOOR: YOHO MAPLE 24,5x150 CM [C-1] / 14,5x120 CM [C-1] - PELDAÑO RECTO 33x120x3 CM [C-1]

OUTDOOR: YOHO MAPLE 16,25x66,5 CM [C-3]



# YOHO / OAK

GRES EXTRUIDO · EXTRUDED KLINKER · GRÈS EXTRUDÉ · ЭКСТРУДИРОВАННЫЙ КЕРАМОГРАНИТ  
GRES PORCELÁNICO · PORCELAIN STONEWARE · GRÈS PORCELAINÉ · КЕРАМОГРАНИТ

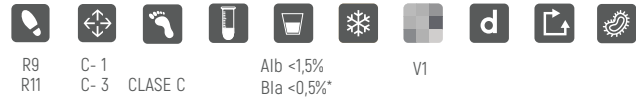

R9 R11 C-1 C-3 CLASE C Alb <1.5% Bla <0.5%\* V1

## FORMATOS · SIZES · FORMATS · ФОРМАТЫ

25x150\*



**25x150\***  
25 x 150 cm - 9.8"x 59.0"

± 9 mm  
rectificado, rectified  
C-1/C-3

14,5x120\*



**14,5x120\***  
14,5 x 120 cm - 5.7"x 47.2"

± 10,1 mm  
rectificado, rectified  
C-1

16,25x66,5



**16,25x66,5**  
16,25 x 66,5 cm - 6.4"x 26.2"

± 10 mm  
C-3

## PIEZAS ESPECIALES · SPECIAL PIECES · PIÈCES SPÉCIALES · СПЕЦИАЛЬНЫЕ ЭЛЕМЕНТЫ



**PELDAÑO RECTO 120**  
33 x 120 x 3 cm - 13.0"x 47.2"x 1.2"

± 12 mm  
rectificado, rectified  
C-1/C-3



**REMATE PELDAÑO RECTO**  
3 x 33 cm - 1.2"x 13.0"

---



**ZANQUÍN INGLETADO RECTO**  
59,6 x 59,6 cm - 23.5"x 23.5"

± 11 mm



**RODAPIÉ**  
9 x 60 cm - 3.6"x 23.6"

± 11 mm

---



**BORDE SKIMMER**  
45 x 75 x 3 cm - 17.7"x 29.5"x 1.2"

rectificado, rectified  
C-3

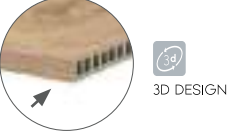

**3D DESIGN**

D. Continuidad gráfica, parte trasera.  
Digitally printed backside.

\* GRES PORCELÁNICO · PORCELAIN STONEWARE · GRÈS PORCELAINÉ · КЕРАМОГРАНИТ

# YOHO / OAK

OUTDOOR: YOHO OAK 24,5x150 CM (C-3) / 14,5x120 CM (C-1) - PELDAÑO RECTO 33x120x3 CM (C-3) - BORDE SKIMMER 45x75x3 CM (C-3)



# YOHO / TECA

GRES EXTRUIDO · EXTRUDED KLINKER · GRÈS EXTRUDÉ · ЭКСТРУДИРОВАННЫЙ КЕРАМОГРАНИТ  
GRES PORCELÁNICO · PORCELAIN STONEWARE · GRÈS PORCELAINÉ · КЕРАМОГРАНИТ





R9 R11 C-1 C-3 CLASE C Alb <1,5% Bla <0,5%\* V1

FORMATOS · SIZES · FORMATS · ФОРМАТЫ

PIEZAS ESPECIALES · SPECIAL PIECES · PIÈCES SPÉCIALES · СПЕЦИАЛЬНЫЕ ЭЛЕМЕНТЫ



 <p><b>25x150*</b> 25 x 150 cm - 9.8"x 59.0"</p> <p>± 9 mm rectificado, rectified C-1/C-3</p>	 <p><b>14,5x120*</b> 14,5 x 120 cm - 5.7"x 47.2"</p> <p>± 10,1 mm rectificado, rectified C-1</p>	 <p><b>16,25x66,5</b> 16,25 x 66,5 cm - 6.4"x 26.2"</p> <p>± 10 mm C-3</p>
--	---	---

 <p><b>PELDAÑO RECTO 120</b> 33 x 120 x 3 cm - 13.0"x 47.2"x 1.2"</p> <p>± 12 mm rectificado, rectified C-1/C-3</p>	 <p><b>REMATE PELDAÑO RECTO</b> 3 x 33 cm - 1.2"x 13.0"</p>
 <p><b>ZANQUÍN RECTO IZDA/DCHA</b> 42,3 x 17,5 cm - 16.7"x 6.9"</p> <p>± 7,5 mm</p>	 <p><b>RODAPÍE</b> 9 x 60 cm - 3.6"x 23.6"</p> <p>± 11 mm</p>
 <p><b>BORDE SKIMMER</b> 45 x 75 x 3 cm - 17.7"x 29.5"x 1.2"</p> <p>rectificado, rectified C-3</p>	

 3D DESIGN  
 D. Continuidad gráfica, parte trasera.  
 Digitally printed backside.

\* GRES PORCELÁNICO · PORCELAIN STONEWARE · GRÈS PORCELAINÉ · КЕРАМОГРАНИТ



# YOHO / TECA

OUTOOR: YOHO TECA 24,5x150 CM (C-3) / 16,25x66,5 CM (C-3) - MARKINA BIANCO 60x120 CM (C-1)



WOOD

# NATURA

ANTISLIP WOOD TEXTURE  
OUTDOOR  
STAIRS  
SWIMMINGPOOLS



ES



EN



FR

COLORS:      SIZES (cm):      SIZES (inches):

KENIA		
ETNA		
CRETA	16,25x66,5 cm	6.4"x26.2"



NATURA ETNA 16,25x66,5 CM - CHROMATIC 16,25x66,5 CM

# NATURA /

GRES EXTRUIDO · EXTRUDED KLINKER · GRÈS EXTRUDÉ · ЭКСТРУДИРОВАННЫЙ КЕРАМОГРАНИТ

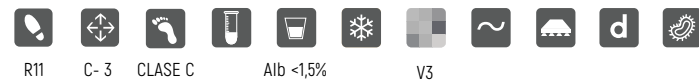

KENIA

ETNA

CRETA



FORMATOS · SIZES · FORMATS · ФОРМАТЫ

## KENIA / ETNA / CRETA



DECORADOS · DECORS · DÉCORÉ · УКРАШЕН



**NOTE KENIA\***  
16,25 x 66,5 cm - 6.4"x 26.2"  
± 10 mm \*1 set 3 piezas - 3 pieces pack



**CHROMATIC\***  
16,25 x 66,5 cm - 6.4"x 26.2"  
± 10 mm \*1 set 6 piezas - 6 pieces pack

PIEZAS ESPECIALES · SPECIAL PIECES · PIÈCES SPÉCIALES · СПЕЦИАЛЬНЫЕ ЭЛЕМЕНТЫ

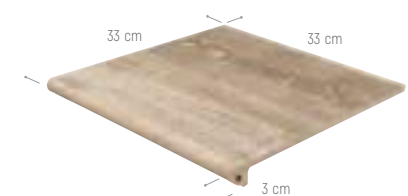

**PELDAÑO FIORENTINO**  
33 x 33 x 3 cm - 13.0"x 13.0" x 1.2"  
± 12 mm

☒ C-3

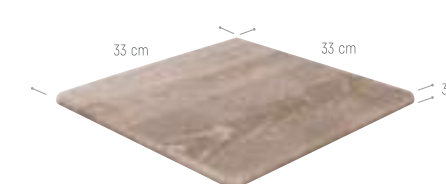

**CARTABÓN FIORENTINO IZDA/DCHA.**  
33 x 33 x 3 cm - 13.0"x 13.0" x 1.2"

± 14 mm  
☒ rectificado, rectified  
☒ C-3



**ZANQUÍN FIORENTINO IZDA/DCHA**  
39,5 x 17,5 cm - 15.6"x 6.9"  
± 7,5 mm



**RODAPIÉ**  
9 x 33 cm - 3.6"x 13.0"  
± 11 mm



**BORDE PISCINA**  
28 x 66,5 cm - 11.0"x 26.2"  
± 10 mm

☒ C-3

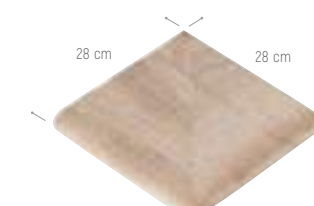

**ÁNGULO EXTERIOR PISCINA**  
28 x 28 cm - 11.0"x 11.0"  
± 10 mm

☒ rectificado, rectified  
☒ C-3



**ÁNGULO INTERIOR PISCINA**  
33 x 33 cm - 13.0"x 13.0"  
± 10 mm

☒ rectificado, rectified  
☒ C-3



**16,25x66,5**  
16,25 x 66,5 cm - 6.4"x 26.2"  
± 10 mm

☒ C-3

# NATURA / KENIA

INDOOR / OUTDOOR: NATURA KENIA 16,25x66,5 CM - PELDAÑO FIORENTINO 33x33x3 CM



# / CRETA

OUTDOOR: NATURA CRETA 16,25x66,5 CM - BORDE PISCINA 28x66,5 CM - ÁNGULO INTERIOR PISCINA 33x33 CM

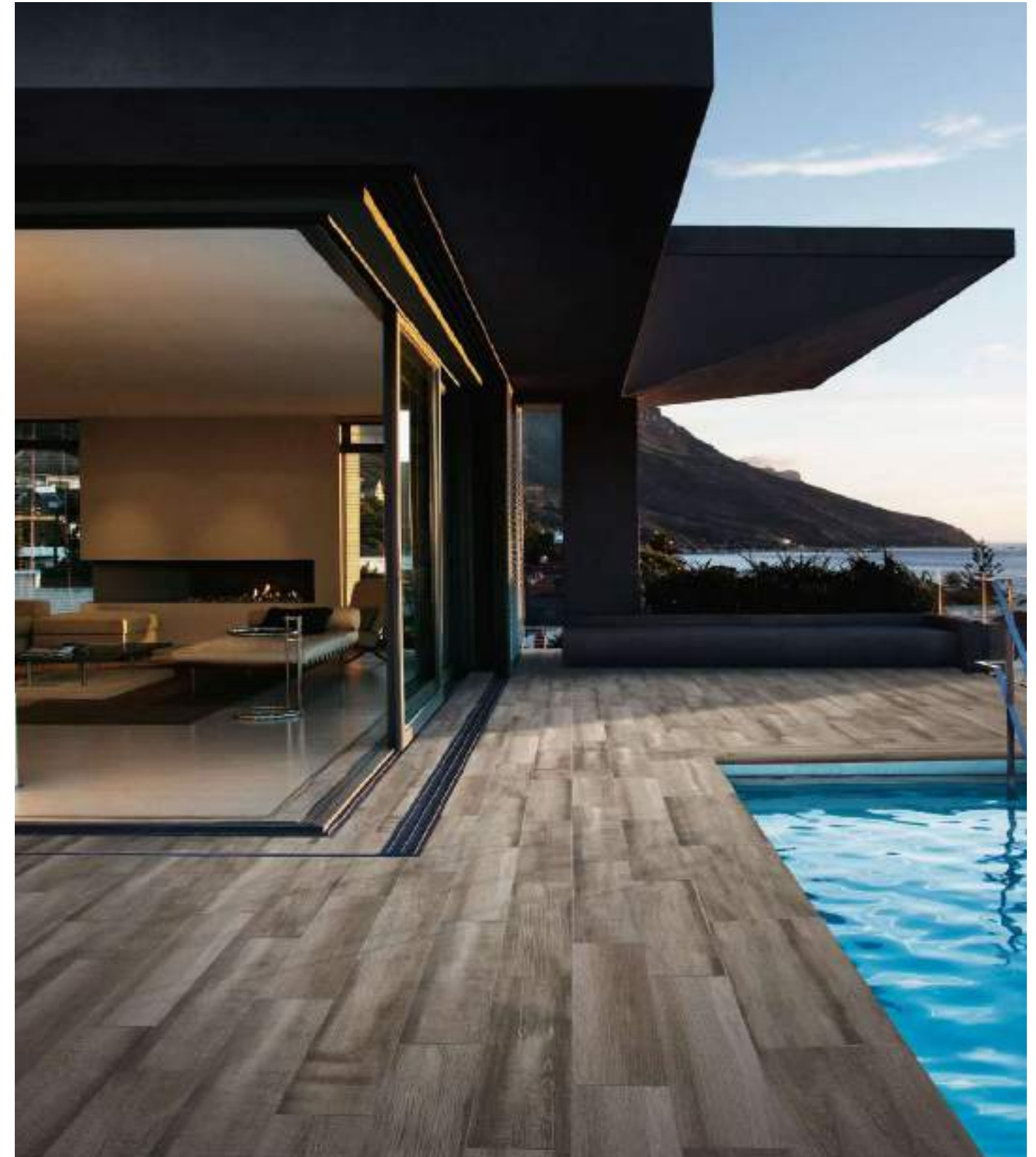

URBAN

# COSMOS

URBAN RUSTY METAL  
IN&OUTDOOR  
STAIRS  
SWIMMINGPOOLS



ES



EN



FR

COLORS:	SIZES (cm):	SIZES (inches):
STEEL	120x120 cm	47.2"x47.2"
COPPER	60x120 cm	23.6"x47.2"
CORTEN	14,5x120 cm	5.7"x47.2"
VENUS	33x66,5 cm	13.0"x26.2"



COSMOS CORTEN 120x120 CM [C-1]

# COSMOS / STEEL



GRES EXTRUIDO · EXTRUDED KLINKER · GRÈS EXTRUDÉ · ЭКСТРУДИРОВАННЫЙ КЕРАМОГРАНИТ  
 \*GRES PORCELÁNICO · PORCELAIN STONWARE · GRÈS PORCELAINÉ · КЕРАМОГРАНИТ

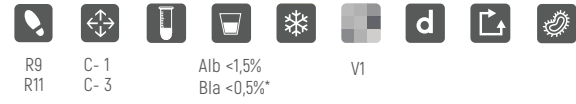

R9 C-1 Alb <1,5% V1  
 R11 C-3 Bla <0,5%

## FORMATOS · SIZES · FORMATS · ФОРМАТЫ

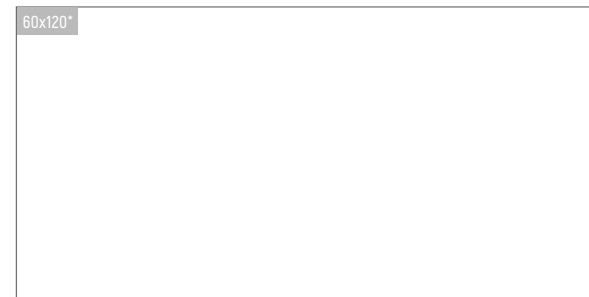
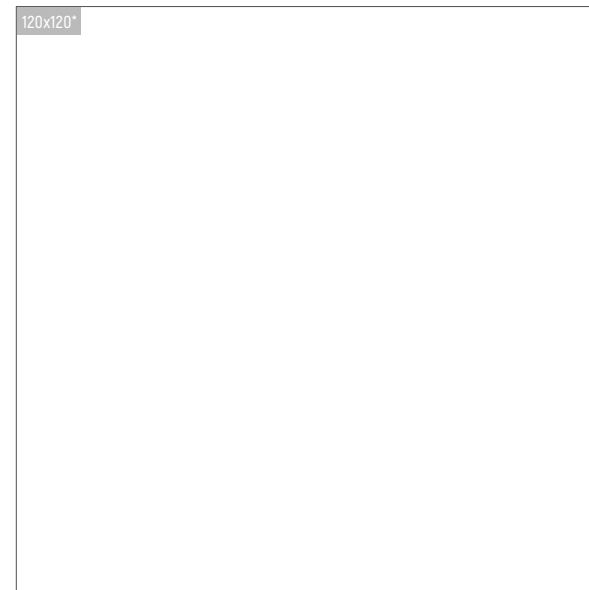

<b>120x120*</b> 120 x 120 cm - 47.2"x 47.2" ✂ 11 mm ✂ rectificado, rectified ✂ C-1	<b>60x120*</b> 60 x 120 cm - 23.6"x 47.2" ✂ 10,1 mm ✂ rectificado, rectified ✂ C-1	<b>14,5x120*</b> 14,5 x 120 cm - 5.7"x 47.2" ✂ 10,1 mm ✂ rectificado, rectified ✂ C-1	<b>33x66,5</b> 33 x 66,5 cm - 13.0"x 26.2" ✂ 10 mm ✂ C-1/C-3
---	---	--	--

## PIEZAS ESPECIALES · SPECIAL PIECES · PIÈCES SPÉCIALES · СПЕЦИАЛЬНЫЕ ЭЛЕМЕНТЫ



**PELDAÑO RECTO 120**  
 33 x 120 x 3 cm - 13.0"x 47.2"x1.2"  
 ✂ 12 mm  
 ✂ rectificado, rectified  
 ✂ C-1/C-3



**REMATE PELDAÑO RECTO**  
 3 x 33 cm - 1.2"x 13.0"



**RODAPIÉ**  
 9 x 60 cm - 3.6"x 23.6"  
 ✂ 11 mm

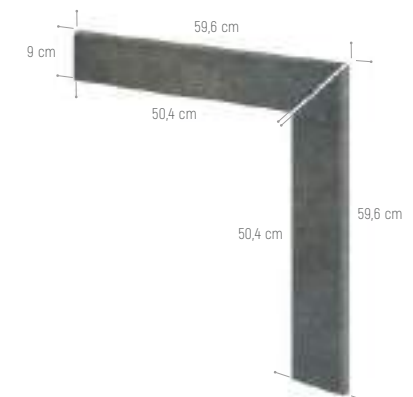

**ZANQUÍN INGLETADO RECTO**  
 59,6 x 59,6 cm - 23.5"x 23.5"  
 ✂ 11 mm

\* GRES PORCELÁNICO · PORCELAIN STONWARE · GRÈS PORCELAINÉ · КЕРАМОГРАНИТ

# COSMOS / STEEL

COSMOS STEEL 120x120 CM [C-1] - PELDAÑO RECTO 120 - 33x120x3 CM [C-1] - REMATE PELDAÑO RECTO 3x33 CM - TABICA 14,5x120 CM - COSMOS CORTEN 120x120 CM [C-1]



# COSMOS / STEEL



OUTDOOR: COSMOS STEEL 33x66,5 CM [C-3] - PELDAÑO RECTO 120 33x120x3 CM [C-3] - TABICA 14,5x120 CM [C-1]

INDOOR: COSMOS 33x66,5 CM [C-1]





# COSMOS / STEEL

INDOOR: COSMOS STEEL 60x120 CM [C-1] - PELDAÑO RECTO 120 - 33x120x3 CM [C-1] - TABICA 14,5x120 CM [C-1] - COSMOS CORTEN 60x120 CM [C-1]



# COSMOS / COPPER

exagres  
TECHNICAL SOLUTIONS

GRES EXTRUIDO · EXTRUDED KLINKER · GRÈS EXTRUDÉ · ЭКСТРУДИРОВАННЫЙ КЕРАМОГРАНИТ  
GRES PORCELÁNICO · PORCELAIN STONEWARE · GRÈS PORCELAINÉ · КЕРАМОГРАНИТ



R9 C-1 Alb <1,5% V1  
R11 C-3 Bla <0,5%

FORMATOS · SIZES · FORMATS · ФОРМАТЫ

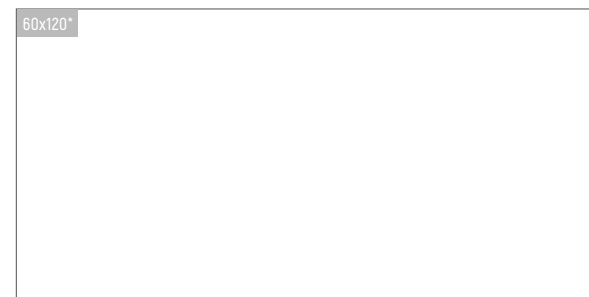
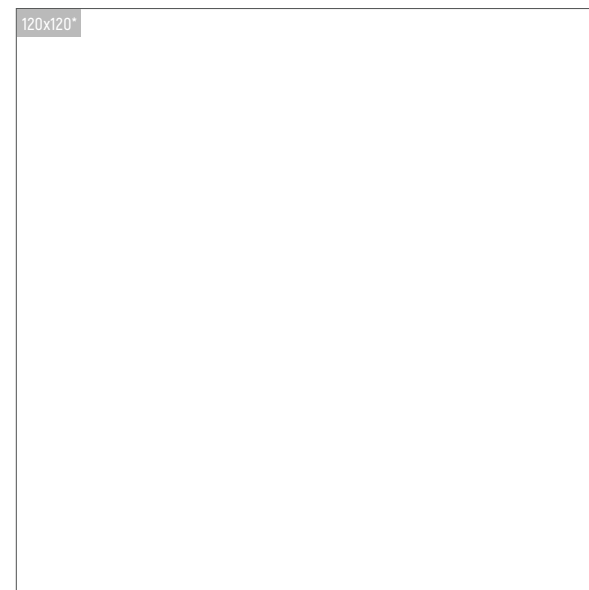

**120x120\***  
120 x 120 cm -  
47.2"x 47.2"

11 mm  
rectificado, rectified  
C-1

**60x120\***  
60 x 120 cm -  
23.6"x 47.2"

10,1 mm  
rectificado, rectified  
C-1

**14,5x120\***  
14,5 x 120 cm -  
5.7"x 47.2"

10,1 mm  
rectificado, rectified  
C-1

**33x66,5**  
33 x 66,5 cm -  
13.0"x 26.2"

10 mm  
C-1/C-3

PIEZAS ESPECIALES · SPECIAL PIECES · PIÈCES SPÉCIALES · СПЕЦИАЛЬНЫЕ ЭЛЕМЕНТЫ



**PELDAÑO RECTO 120**  
33 x 120 x 3 cm - 13.0"x 47.2"x1.2"

12 mm  
rectificado, rectified  
C-1/C-3



**REMATE PELDAÑO RECTO**  
3 x 33 cm - 1.2"x 13.0"



**ZANQUÍN INGLETADO RECTO**  
59,6 x 59,6 cm - 23.5"x 23.5"

11 mm



**RODAPIÉ**  
9 x 60 cm - 3.6"x 23.6"

11 mm

\* GRES PORCELÁNICO · PORCELAIN STONEWARE · GRÈS PORCELAINÉ · КЕРАМОГРАНИТ

# COSMOS / COPPER

COSMOS COPPER 120x120 CM [C-1] - PELDAÑO RECTO 120 · 33x120x3 CM [C-1] - TABICA 14,5x120 CM [C-1] - LIZANA HAYA 25x150 CM [C-1]



# COSMOS / COPPER

INDOOR: COSMOS COPPER 60x120 CM [C-1] - PELDAÑO RECTO 120 - 33x120x3 CM [C-1] - TABICA 14,5x120 CM [C-1]

OUTDOOR: COSMOS VENUS 33x66,5 CM [C-3] - PELDAÑO RECTO 120 - 33x120x3 CM [C-3]



# COSMOS / CORTEN

GRES EXTRUIDO · EXTRUDED KLINKER · GRÈS EXTRUDÉ · ЭКСТРУДИРОВАННЫЙ КЕРАМОГРАНИТ  
GRES PORCELÁNICO · PORCELAIN STONWARE · GRÈS PORCELAINÉ · КЕРАМОГРАНИТ



R9 C-1 Alb <1,5% V1  
R11 C-3 Bla <0,5%

## FORMATOS · SIZES · FORMATS · ФОРМАТЫ

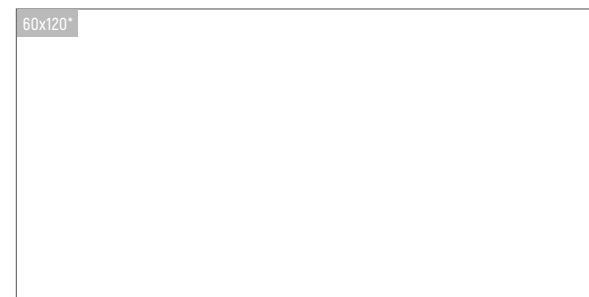
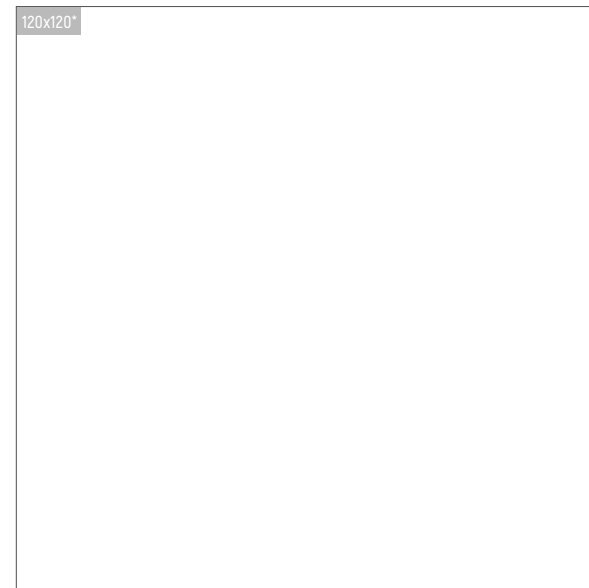

**120x120\***  
120 x 120 cm -  
47.2"x 47.2"

11 mm  
rectificado, rectified  
C-1

**60x120\***  
60 x 120 cm -  
23.6"x 47.2"

10,1 mm  
rectificado, rectified  
C-1

**14,5x120\***  
14,5 x 120 cm -  
5.7"x 47.2"

10,1 mm  
rectificado, rectified  
C-1

**33x66,5**  
33 x 66,5 cm -  
13.0"x 26.2"

10 mm  
C-1/C-3

## PIEZAS ESPECIALES · SPECIAL PIECES · PIÈCES SPÉCIALES · СПЕЦИАЛЬНЫЕ ЭЛЕМЕНТЫ



**PELDAÑO RECTO 120**  
33 x 120 x 3 cm - 13.0"x 47.2"x1.2"

12 mm  
rectificado, rectified  
C-1/C-3



**REMATE PELDAÑO RECTO**  
3 x 33 cm - 1.2"x 13.0"

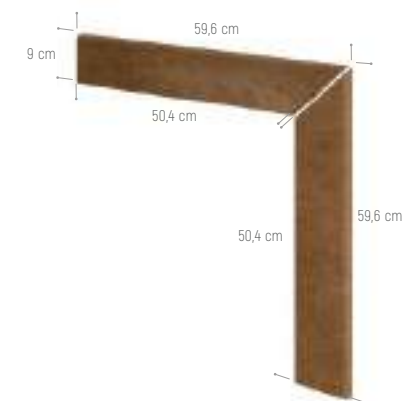

**ZANQUÍN INGLETADO RECTO**  
59,6 x 59,6 cm - 23.5"x 23.5"

11 mm



**RODAPIÉ**  
9 x 60 cm - 3.6"x 23.6"

11 mm

# COSMOS / CORTEN

COSMOS CORTEN 120x120 CM [C-1] - PELDAÑO RECTO 120 - 33x120x3 CM [C-1] - TABICA 14,5x120 CM [C-1] - LIZANA HAYA 20x120 CM [C-1]



# COSMOS / CORTEN



OUTDOOR: COSMOS CORTEN 33x66,5 CM [C-3] - PELDAÑO RECTO 120 - 33x120x3 CM [C-3] - IMPERIAL ARIAN 60x120 CM [C-1]

INDOOR: COSMOS CORTEN 60x120 CM [C-1]



# COSMOS / CORTEN

INDOOR: COSMOS CORTEN 60x120 CM [C-1] - PELDAÑO RECTO 120 - 33x120x3 CM [C-1] - TABICA 14,5x120 CM [C-1]

LIZANA HAYA 20x120 CM [C-1] - PELDAÑO RECTO 120 - 33x120x3 CM [C-1] - TABICA 14,5x120 CM [C-1]





# COSMOS / VENUS



GRES EXTRUIDO · EXTRUDED KLINKER · GRÈS EXTRUDÉ · ЭКСТРУДИРОВАННЫЙ КЕРАМОГРАНИТ  
 \*GRES PORCELÁNICO · PORCELAIN STONEWARE · GRÈS PORCELAINÉ · КЕРАМОГРАНИТ

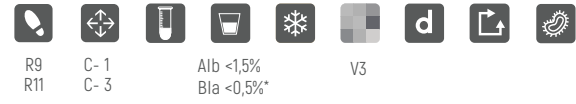

R9 C-1 Alb <1,5% V3  
 R11 C-3 Bla <0,5%\*

## FORMATOS · SIZES · FORMATS · ФОРМАТЫ

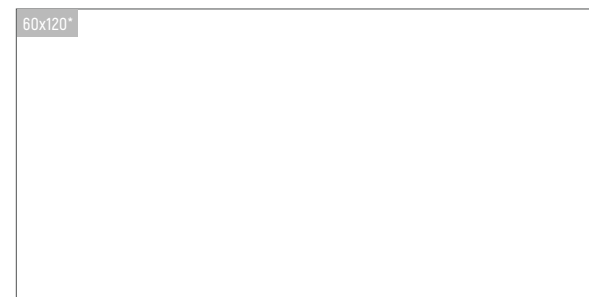
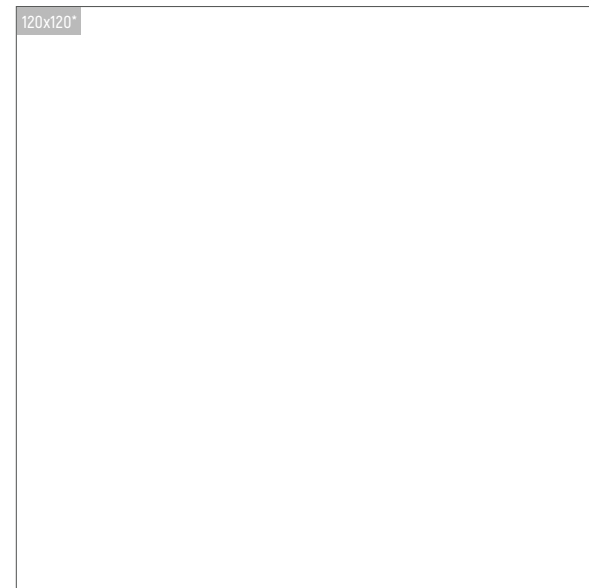

<b>120x120*</b> 120 x 120 cm - 47.2"x 47.2" ✂ 11 mm ✂ rectificado, rectified ✂ C-1	<b>60x120*</b> 60 x 120 cm - 23.6"x 47.2" ✂ 10,1 mm ✂ rectificado, rectified ✂ C-1	<b>14,5x120*</b> 14,5 x 120 cm - 5.7"x 47.2" ✂ 10,1 mm ✂ rectificado, rectified ✂ C-1	<b>33x66,5</b> 33 x 66,5 cm - 13.0"x 26.2" ✂ 10 mm ✂ C-1/C-3
---	---	--	--

## PIEZAS ESPECIALES · SPECIAL PIECES · PIÈCES SPÉCIALES · СПЕЦИАЛЬНЫЕ ЭЛЕМЕНТЫ



**PELDAÑO RECTO 120**  
 33 x 120 x 3 cm - 13.0"x 47.2"x1.2"  
 ✂ 12 mm  
 ✂ rectificado, rectified  
 ✂ C-1/C-3



**REMATE PELDAÑO RECTO**  
 3 x 33 cm - 1.2"x 13.0"



**RODAPIÉ**  
 9 x 60 cm - 3.6"x 23.6"  
 ✂ 11 mm



**ZANQUÍN INGLETADO RECTO**  
 59,6 x 59,6 cm - 23.5"x 23.5"  
 ✂ 11 mm

\*GRES PORCELÁNICO · PORCELAIN STONEWARE · GRÈS PORCELAINÉ · КЕРАМОГРАНИТ

# COSMOS / VENUS

INDOOR: COSMOS VENUS 120x120 CM [C-1] - PELDAÑO RECTO 120 · 33x120x3 CM [C-1] - TABICA 14,5x120 CM [C-1] - COSMOS CORTEN 60x120 CM [C-1]



# COSMOS / VENUS



OUTDOOR: COSMOS VENUS 33x66,5 CM [C-3] - PELDAÑO RECTO 120 - 33x120x3 CM [C-3] - TABICA 14,5x120 CM [C-1]

INDOOR: COSMOS VENUS 60x120 CM [C-1]



# COSMOS / VENUS

INDOOR: COSMOS VENUS 60x120 CM (C-1) - PELDAÑO RECTO 120 - 33x120x3 CM (C-1) - TABICA 14,5x120 CM



# ÓPERA

CONCRETE & INDUSTRIAL TREND  
IN&OUTDOOR  
LARGE FORMATS  
STAIRS  
SWIMMINGPOOLS



ES / EN

COLORS:	SIZES (cm):	SIZES (inches):
LIGHT	120x120 cm	47.2"x47.2"
IVORY	60x120 cm	23.6"x47.2"
SILVER	14,5x120 cm	5.7"x47.2"
IRON	33x66,5 cm	13.0"x26.2"

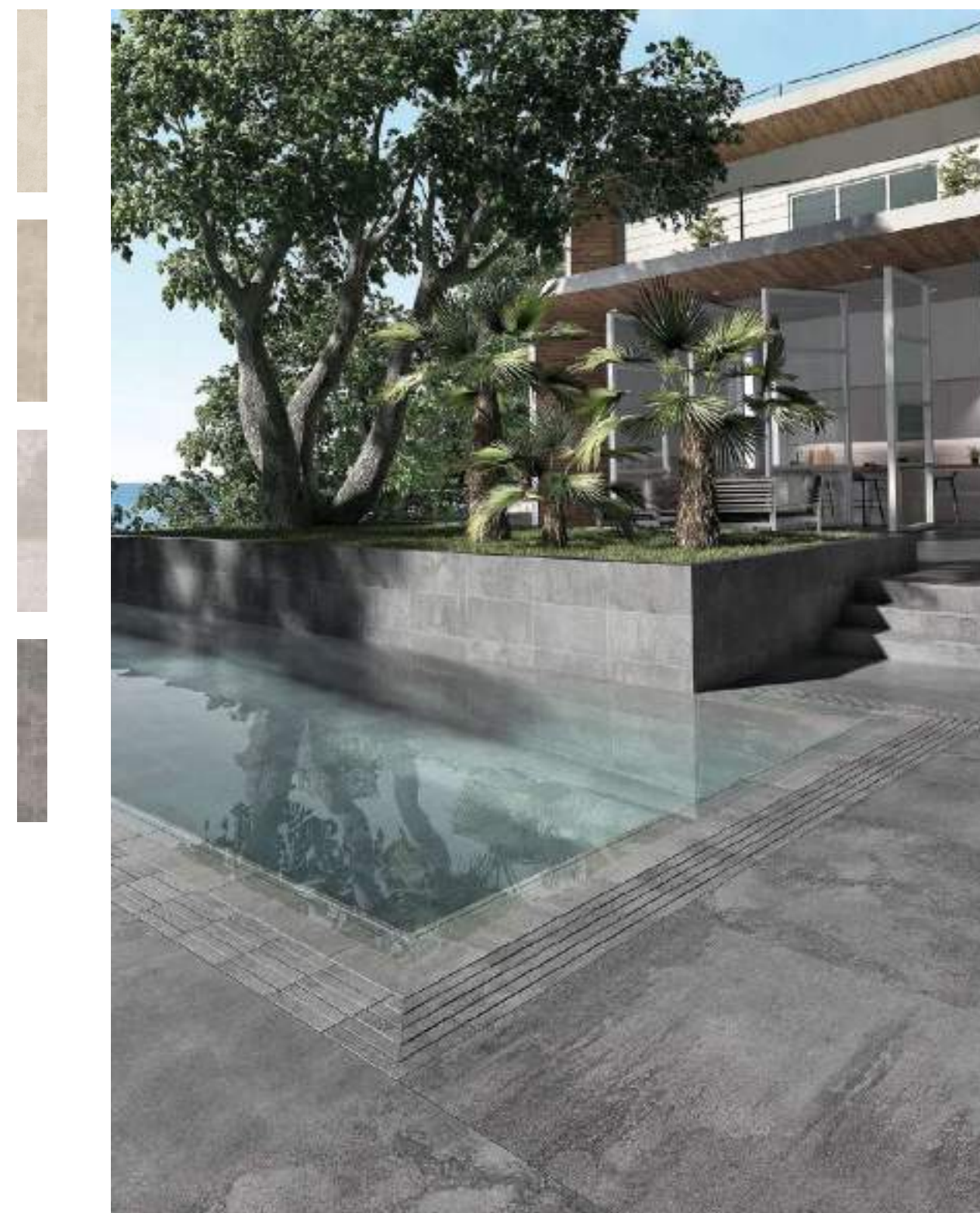

ÓPERA IRON 120x120 CM [C-3] - ÓPERA IRON 33x66,5 CM [C-1] / 14,5x120 CM [C-1] - PELDAÑO RECTO 33x120x3 CM [C-3] -BORDE DESBORDANTE 28x66,5 CM [C-3] - ÁNG. DESBORDANTE 31x31 CM [C-3] - REJILLA 24,5x24,5 CM - ANG. REJILLA 24,5x33 CM - MEDIA CAÑA 33x4 CM

# ÓPERA / IVORY



GRES EXTRUIDO · EXTRUDED KLINKER · GRÈS EXTRUDÉ · ЭКСТРУДИРОВАННЫЙ КЕРАМОГРАНИТ  
GRES PORCELÁNICO · PORCELAIN STONEWARE · GRÈS PORCELAINÉ · КЕРАМОГРАНИТ



R9 C-1 CLASE C Alb <1,5% V3  
R12 C-3

## FORMATOS · SIZES · FORMATS · ФОРМАТЫ

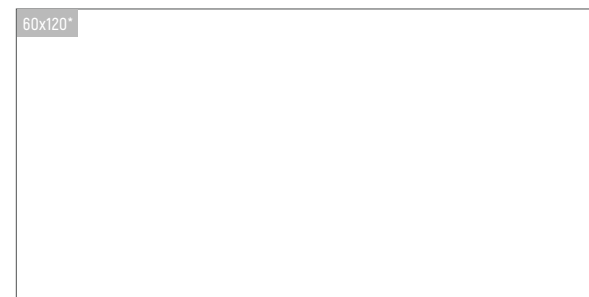
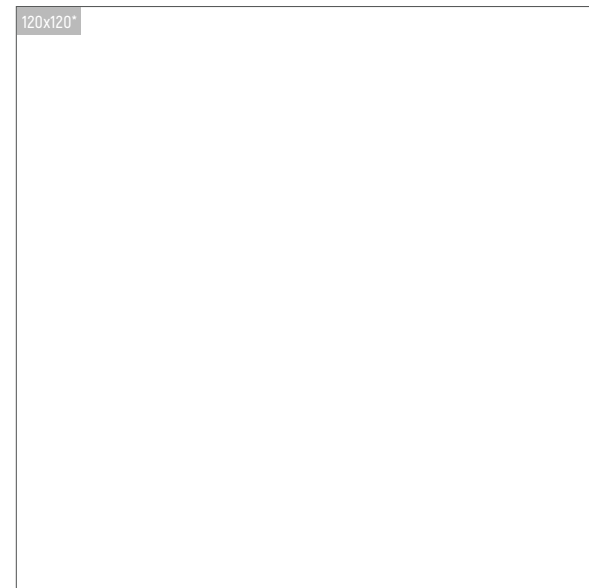

<b>120x120*</b> 120 x 120 cm - 47.2"x 47.2" x 10 mm rectificado. rectified C-1/C-3	<b>60x120*</b> 60 x 120 cm - 23.6"x 47.2" x 10,1 mm rectificado. rectified C-1/C-3	<b>14,5x120*</b> 14,5 x 120 cm - 5.7"x 47.2" x 10,1 mm rectificado. rectified C-1	<b>33x66,5</b> 33 x 66,5 cm - 13.0"x 26.2" x 10 mm rectificado. rectified C-1/C-3
--	--	---	---

## PIEZAS ESPECIALES · SPECIAL PIECES · PIÈCES SPÉCIALES · СПЕЦИАЛЬНЫЕ ЭЛЕМЕНТЫ

**PELDAÑO RECTO 120**  
33 x 120 x 3 cm - 13.0"x 47.2"x 1.2"  
x 12 mm  
rectificado. rectified  
C-1/C-3

**REMATE PELDAÑO RECTO**  
3 x 33 cm - 1.2"x 13.0"

**RODAPIÉ**  
9 x 60 cm - 3.6"x 23.6"  
x 11 mm

**ZANQUÍN RECTO IZDA/DCHA**  
42,3 x 17,5 cm - 16.7"x 6.9"  
x 7,5 mm

**BORDE SKIMMER**  
45 x 75 x 3 cm - 17.7"x 29.5"x 1.2"  
rectificado. rectified  
C-3  
D. Continuidad gráfica, parte trasera. Digitally printed, backside.

**BORDE DESBORDANTE**  
28 x 66,5 cm - 11.0"x 26.2"  
rectificado. rectified  
C-3

**ÁNGULO DESBORDANTE**  
31 x 31 cm - 12.2"x 12.2"  
rectificado. rectified  
C-3

**REJILLA**  
24,5 x 24,5 cm - 9.6"x 9.6"  
rectificado. rectified  
C-3

**ÁNGULO REJILLA IZDA/DCHA\***  
24,5 x 33 cm - 9.6"x 13.0"  
rectificado. rectified  
C-3  
\*set de 2 piezas [izda./dcha.] \*two pieces set [left/right]

**MEDIA CAÑA**  
33 x 4 cm - 13.0"x 1.6"  
r-3 cm

**UÑA**  
4 x 4 cm - 1.6"x 1.6"

**ARISTA**  
33 x 3 cm - 13.0"x 1.2"  
r-3 cm

**UÑA ARISTA**  
3 x 3 cm - 1.2"x 1.2"

# ÓPERA / IVORY

INDOOR: ÓPERA IVORY 120x120 CM (C-1)

OUTDOOR: ÓPERA IVORY 60x120 CM (C-3) - ÓPERA IVORY 120x120 CM (C-3) - BORDE DESBORDANTE 28x66,5 CM (C-3) -

REJILLA 24,5x24,5 CM (C-3) - ÁNGULO DESBORDANTE 31x31 CM - ÁNGULO REJILLA IZDA./DCHA. 24,5x33 CM (C-3) - MEDIA CAÑA 33x4 CM - ÓPERA IVORY 33x66,5 CM (C-1)



# ÓPERA / IVORY

INDOOR: ÓPERA IVORY 120x120 CM (C-1) - 60x120 CM (C-1) - PELDAÑO RECTO 120 33x120x3 CM - TABICA ÓPERA IVORY 14,5x120 CM





# ÓPERA / LIGHT



GRES EXTRUIDO · EXTRUDED KLINKER · GRÈS EXTRUDÉ · ЭКСТРУДИРОВАННЫЙ КЕРАМОГРАНИТ  
GRES PORCELÁNICO · PORCELAIN STONEWARE · GRÈS PORCELAINÉ · КЕРАМОГРАНИТ



R9 C-1 CLASE C Alb <1,5% V3  
R12 C-3

## FORMATOS · SIZES · FORMATS · ФОРМАТЫ

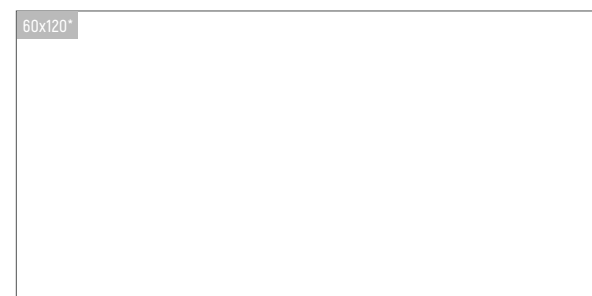
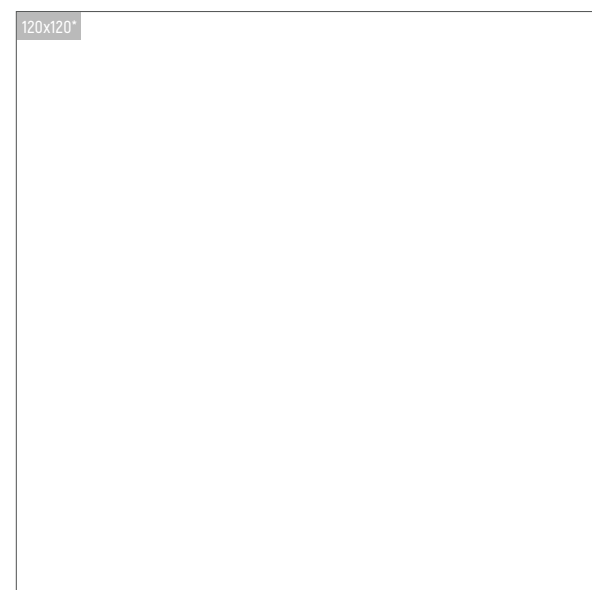

<b>120x120*</b> 120 x 120 cm - 47.2"x 47.2" 10 mm rectificado, rectified C-1/C-3	<b>60x120*</b> 60 x 120 cm - 23.6"x 47.2" 10,1 mm rectificado, rectified C-1/C-3	<b>14,5x120*</b> 14,5 x 120 cm - 5.7"x 47.2" 10,1 mm rectificado, rectified C-1	<b>33x66,5</b> 33 x 66,5 cm - 13.0"x 26.2" 10 mm rectificado, rectified C-1/C-3
--	--	---	---

## PIEZAS ESPECIALES · SPECIAL PIECES · PIÈCES SPÉCIALES · СПЕЦИАЛЬНЫЕ ЭЛЕМЕНТЫ

**PELDAÑO RECTO 120**  
33 x 120 x 3 cm - 13.0"x 47.2"x 1.2"  
 12 mm  
 rectificado, rectified  
 C-1/C-3

**REMATE PELDAÑO RECTO**  
3 x 33 cm - 1.2"x 13.0"

**RODAPIÉ**  
9 x 60 cm - 3.6"x 23.6"  
 11 mm

**ZANQUÍN RECTO IZDA/DCHA**  
42,3 x 17,5 cm - 16.7"x 6.9"  
 7,5 mm

**BORDE SKIMMER**  
45 x 75 x 3 cm - 17.7"x 29.5"x 1.2"  
 rectificado, rectified  
 C-3  
 D. Continuidad gráfica, parte trasera. Digitally printed, backside.

**BORDE DESBORDANTE**  
28 x 66,5 cm - 11.0"x 26.2"  
 rectificado, rectified  
 C-3

**ÁNGULO DESBORDANTE**  
31 x 31 cm - 12.2"x 12.2"  
 rectificado, rectified  
 C-3

**REJILLA**  
24,5 x 24,5 cm - 9.6"x 9.6"  
 rectificado, rectified  
 C-3

**ÁNGULO REJILLA IZDA/DCHA\***  
24,5 x 33 cm - 9.6"x 13.0"  
 rectificado, rectified  
 C-3  
 \*set de 2 piezas [izda/dcha.] \*two pieces set [left/right]

**MEDIA CAÑA**  
33 x 4 cm - 13.0"x 1.6"  
 r-3 cm

**UÑA**  
4 x 4 cm - 1.6"x 1.6"

**ARISTA**  
33 x 3 cm - 13.0"x 1.2"  
 r-3 cm

**UÑA ARISTA**  
3 x 3 cm - 1.2"x 1.2"

\* GRES PORCELÁNICO · PORCELAIN STONEWARE · GRÈS PORCELAINÉ · КЕРАМОГРАНИТ

# ÓPERA / LIGHT

exagres

TECHNICAL SOLUTIONS

OUTDOOR: ÓPERA LIGHT 60x120 CM [C-3] - PELDAÑO RECTO 33x120x3 CM [C-3] - TABICA 14,5x120 CM [C-1] - BORDE SKIMMER 45x75x3 CM [C-3]

INDOOR: ÓPERA LIGHT 60x120 CM [C-1]



# ÓPERA / LIGHT

INDOOR: ÓPERA LIGHT 120x120 CM [C-1] - PELDAÑO RECTO 33x120x3 CM [C-1] - TABICA ÓPERA LIGHT 14,5x120 CM



# ÓPERA / SILVER



GRES EXTRUIDO · EXTRUDED KLINKER · GRÈS EXTRUDÉ · ЭКСТРУДИРОВАННЫЙ КЕРАМОГРАНИТ  
 GRES PORCELÁNICO · PORCELAIN STONEWARE · GRÈS PORCELAINÉ · КЕРАМОГРАНИТ



R9 C-1 Alb <1.5% V3  
 R12 C-3 CLASE C Bla <0.5%\*



## FORMATOS · SIZES · FORMATS · ФОРМАТЫ

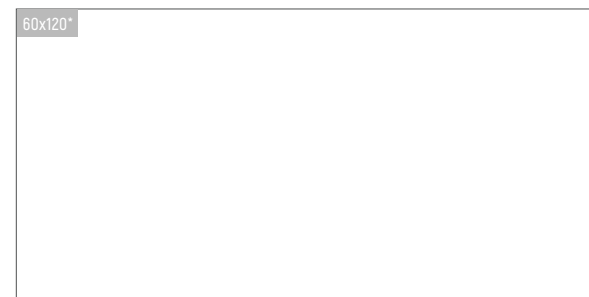
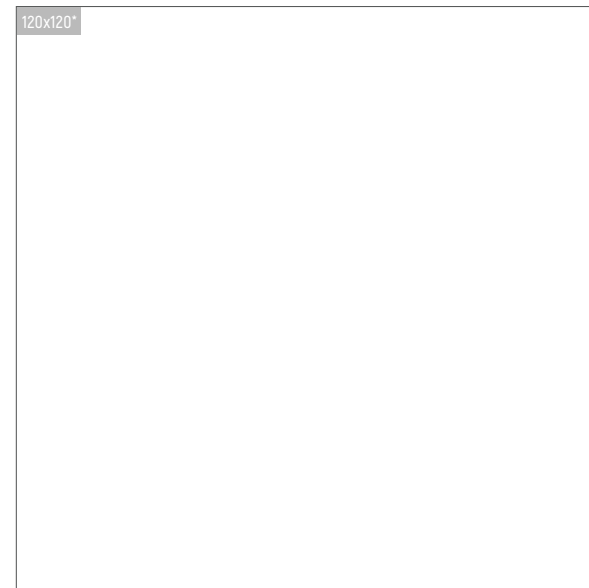

<b>120x120*</b> 120 x 120 cm - 47.2"x 47.2" 10 mm rectificado, rectified C-1/C-3	<b>60x120*</b> 60 x 120 cm - 23.6"x 47.2" 10,1 mm rectificado, rectified C-1/C-3	<b>14,5x120*</b> 14,5 x 120 cm - 5.7"x 47.2" 10,1 mm rectificado, rectified C-1	<b>33x66,5</b> 33 x 66,5 cm - 13.0"x 26.2" 10 mm rectificado, rectified C-1/C-3
--	--	---	---

## PIEZAS ESPECIALES · SPECIAL PIECES · PIÈCES SPÉCIALES · СПЕЦИАЛЬНЫЕ ЭЛЕМЕНТЫ



**PELDAÑO RECTO 120**  
 33 x 120 x 3 cm - 13.0"x 47.2"x 1.2"  
 12 mm  
 rectificado, rectified  
 C-1/C-3



**REMATE PELDAÑO RECTO**  
 3 x 33 cm - 1.2"x 13.0"



**RODAPIÉ**  
 9 x 60 cm - 3.6"x 23.6"  
 11 mm



**ZANQUÍN RECTO IZDA/DCHA**  
 42,3 x 17,5 cm - 16.7"x 6.9"  
 7,5 mm



**BORDE SKIMMER**  
 45 x 75 x 3 cm - 17.7"x 29.5"x 1.2"  
 rectificado, rectified  
 C-3



D. Continuidad gráfica, parte trasera.  
 Digitally printed, backside.



**BORDE DESBORDANTE**  
 28 x 66,5 cm - 11.0"x 26.2"  
 rectificado, rectified  
 C-3



**ÁNGULO DESBORDANTE**  
 31 x 31 cm - 12.2"x 12.2"  
 rectificado, rectified  
 C-3

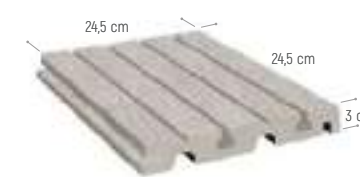

**REJILLA**  
 24,5 x 24,5 cm - 9.6"x 9.6"  
 rectificado, rectified  
 C-3



**ÁNGULO REJILLA IZDA/DCHA\***  
 24,5 x 33 cm - 9.6"x 13.0"  
 rectificado, rectified  
 C-3

\*set de 2 piezas [izda/dcha] \*two pieces set [left/right]



**MEDIA CAÑA**  
 33 x 4 cm - 13.0"x 1.6"  
 r-3 cm



**UÑA**  
 4 x 4 cm - 1.6"x 1.6"



**ARISTA**  
 33 x 3 cm - 13.0"x 1.2"  
 r-3 cm



**UÑA ARISTA**  
 3 x 3 cm - 1.2"x 1.2"

\* GRES PORCELÁNICO · PORCELAIN STONEWARE · GRÈS PORCELAINÉ · КЕРАМОГРАНИТ

# ÓPERA / SILVER

exagres

TECHNICAL SOLUTIONS

OUTDOOR: ÓPERA SILVER 60x120 CM [C-3] / 120x120 CM [C-3] - BORDE SKIMMER 45x75x3 CM [C-3] - ÓPERA SILVER 33x66,5 CM [C-1] - MEDIA CAÑA 33x4 CM - UÑA 4x4 CM

INDOOR: ÓPERA SILVER 60x120 CM [C-1]



# ÓPERA / IRON



GRES EXTRUIDO · EXTRUDED KLINKER · GRÈS EXTRUDÉ · ЭКСТРУДИРОВАННЫЙ КЕРАМОГРАНИТ  
GRES PORCELÁNICO · PORCELAIN STONEWARE · GRÈS PORCELAINÉ · КЕРАМОГРАНИТ



R9 C-1 CLASE C Alb <1,5% V3  
R12 C-3



## FORMATOS · SIZES · FORMATS · ФОРМАТЫ

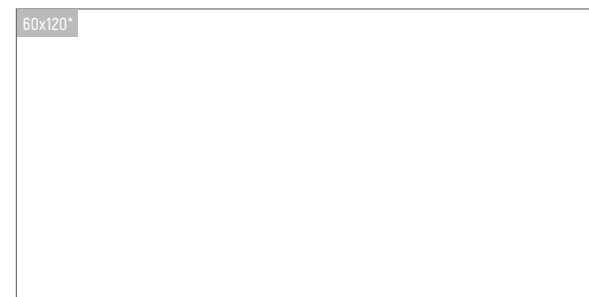
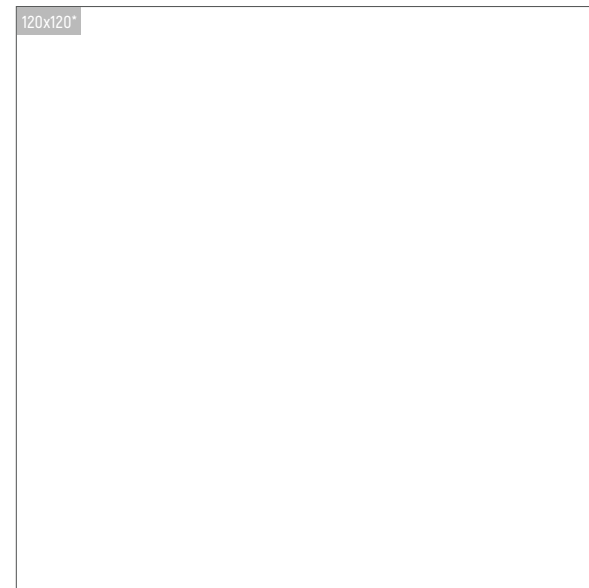

<b>120x120*</b> 120 x 120 cm - 47.2"x 47.2" 10 mm rectificado, rectified C-1/C-3	<b>60x120*</b> 60 x 120 cm - 23.6"x 47.2" 10,1 mm rectificado, rectified C-1/C-3	<b>14,5x120*</b> 14,5 x 120 cm - 5.7"x 47.2" 10,1 mm rectificado, rectified C-1	<b>33x66,5</b> 33 x 66,5 cm - 13.0"x 26.2" 10 mm rectificado, rectified C-1/C-3
--	--	---	---

## PIEZAS ESPECIALES · SPECIAL PIECES · PIÈCES SPÉCIALES · СПЕЦИАЛЬНЫЕ ЭЛЕМЕНТЫ



**PELDAÑO RECTO 120**  
33 x 120 x 3 cm - 13.0"x 47.2"x 1.2"  
 12 mm  
 rectificado, rectified  
 C-1/C-3



**REMATE PELDAÑO RECTO**  
3 x 33 cm - 1.2"x 13.0"



**RODAPIÉ**  
9 x 60 cm - 3.6"x 23.6"  
 11 mm



**ZANQUÍN RECTO IZDA/DCHA**  
42,3 x 17,5 cm - 16.7"x 6.9"  
 7,5 mm



**BORDE SKIMMER**  
45 x 75 x 3 cm - 17.7"x 29.5"x 1.2"  
 rectificado, rectified  
 C-3



D. Continuidad gráfica, parte trasera. Digitally printed, backside.



**BORDE DESBORDANTE**  
28 x 66,5 cm - 11.0"x 26.2"  
 rectificado, rectified  
 C-3



**ÁNGULO DESBORDANTE**  
31 x 31 cm - 12.2"x 12.2"  
 rectificado, rectified  
 C-3



**REJILLA**  
24,5 x 24,5 cm - 9.6"x 9.6"  
 rectificado, rectified  
 C-3



**ÁNGULO REJILLA IZDA/DCHA\***  
24,5 x 33 cm - 9.6"x 13.0"  
 rectificado, rectified  
 C-3

\*set de 2 piezas [izda/dcha.] \*two pieces set [left/right]



**MEDIA CAÑA**  
33 x 4 cm - 13.0"x 1.6"  
 r-3 cm



**UÑA**  
4 x 4 cm - 1.6"x 1.6"



**ARISTA**  
33 x 3 cm - 13.0"x 1.2"  
 r-3 cm



**UÑA ARISTA**  
3 x 3 cm - 1.2"x 1.2"

\* GRES PORCELÁNICO · PORCELAIN STONEWARE · GRÈS PORCELAINÉ · КЕРАМОГРАНИТ

# ÓPERA / IRON

exagres

TECHNICAL SOLUTIONS

INDOOR: ÓPERA IRON 60x120 CM [C-1]

OUTDOOR: ÓPERA IRON 120x120 CM [C-3] - BORDE SKIMMER 45x75x3 CM [C-3]



# ÓPERA / IRON

INDOOR: ÓPERA IRON 60x120 CM (C-1) - YOHO OAK 24,5x150 CM (C-1)





URBAN

# MEDITERRÁNEO

CEMENT SLATE DESIGN  
IN&OUTDOOR  
STAIRS



ES



EN



FR

COLORS:      SIZES (cm):      SIZES (inches):

ARENA	33x66,5 cm	13.0"x26.2"
GRAFITO	33x33 cm	13.0"x13.0"



PELDAÑO RECTO GRAFITO 33x33x3 CM (C-1) - ZANQUÍN RECTO IZDA. GRAFITO 42,3x17,5 CM

# MEDITERRÁNEO /

GRES EXTRUIDO · EXTRUDED KLINKER · GRÈS EXTRUDÉ · ЭКСТРУДИРОВАННЫЙ КЕРАМОГРАНИТ



R9  
R11

C-1  
C-3

Alib <1,5%

V1

ARENA

GRAFITO



FORMATOS · SIZES · FORMATS · ФОРМАТЫ

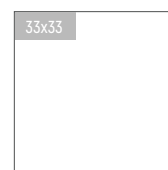

**33x66,5**  
33 x 66,5 cm -  
13.0"x 26.2"

10 mm  
C-1 / C-3

**33x33**  
33 x 33 cm -  
13.0"x 13.0"

10 mm  
C-1 / C-3

# ARENA / GRAFITO



PIEZAS ESPECIALES · SPECIAL PIECES · PIÈCES SPÉCIALES · СПЕЦИАЛЬНЫЕ ЭЛЕМЕНТЫ



**PELDAÑO FIORENTINO**  
33 x 33 x 3 cm - 13.0"x 13.0"x1.2"

12 mm  
C-1/C-3

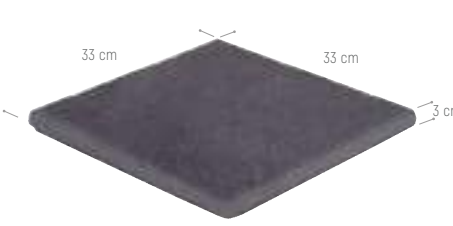

**CARTABÓN FIORENTINO**  
33 x 33 x 3 cm - 13.0"x 13.0"x1.2"

14 mm  
C-1/C-3  
rectificado, rectified



**PELDAÑO RECTO**  
33 x 33 x 3 cm - 13.0"x 13.0"x1.2"

12 mm  
C-1/C-3

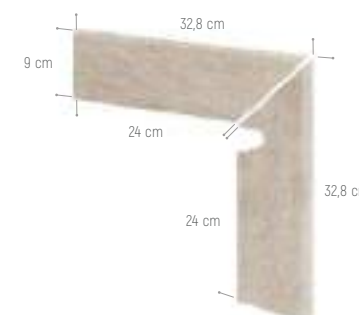

**ZANQUÍN FIORENTINO IZDA./DCHA\***  
32,8 x 32,8 cm - 12.9"x 12.9"

11 mm

\*sólo color arena. only arena color.



**ZANQUIN FIORENTINO IZDA./DCHA.**  
39,5 x 17,5 cm - 15.6"x 6.9"

7,5 mm

\*sólo color grafito. only grafito color.



**ZANQUIN RECTO IZDA./DCHA.**  
42,3 x 17,5 cm - 16.7"x 6.9"

7,5 mm



**RODAPIÉ**  
9 x 33 cm - 3.6"x 13.0"

11 mm



**VIERTEAGUAS**  
12 x 33 x 3 cm - 3.6"x 13.0"x1.2"

12 mm



**PASAMANOS 12\***  
12,5 x 66,5 x 4 cm - 4.9"x 26.2"x1.6"



**PASAMANOS 15\***  
15,5 x 66,5 x 4 cm - 6.1"x 26.2"x1.6"

\*medidas interiores. inner measures.

# MEDITERRÁNEO / ARENA

OUTDOOR: MEDITERRÁNEO ARENA 33x66,5 CM (C-3) - PELDAÑO RECTO 33x33x3 CM (C-3)



STONE



# ARDENAS / ARDENAS

PIERRE BELGE  
IN&OUTDOOR  
MULTIFORMAT  
STAIRS  
SWIMMINGPOOLS  
2 CM OUTDOOR



ES



EN



FR

COLORS:

SIZES (cm):

SIZES (inches):

120x120 cm

47.2"x47.2"

60x120 cm

23.6"x47.2"

60x120 cm **espesorado**

23.6"x47.2" **2 cm outdoor**

14,5x120 cm

5.7"x47.2"

MARFIL

33x66,5 cm

13.0"x26.2"

CROMO

33x33 cm

13.0"x13.0"

GRIS

16,25x33 cm

6.4"x13.0"

ANTRACITA

16,25x16,25 cm

6.4"x6.4"



ARDENAS GRIS 33x66,5 CM [C-3] - 33x33 CM [C-3] - 16,25x33 CM [C-3] - 16,25x16,25 CM [C-3] - BORDE SKIMMER 45x75x3 CM [C-3] - ARDENAS GRIS 2 CM OUTDOOR [C-3]

# ARDENAS / MARFIL



GRES EXTRUIDO · EXTRUDED KLINKER · GRÈS EXTRUDÉ · ЭКСТРУДИРОВАННЫЙ КЕРАМОГРАНИТ  
GRES PORCELÁNICO · PORCELAIN STONEWARE · GRÈS PORCELAINÉ · КЕРАМОГРАНИТ

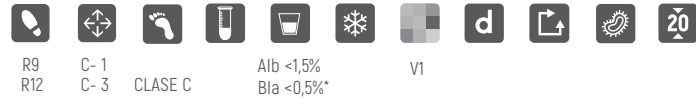

R9 C-1 Alb <1,5% V1  
R12 C-3 CLASE C Bla <0,5%\*

FORMATOS · SIZES · FORMATS · ФОРМАТЫ

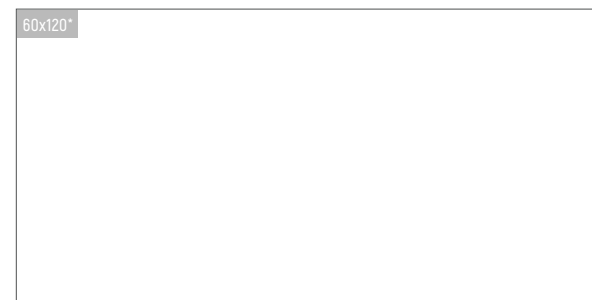
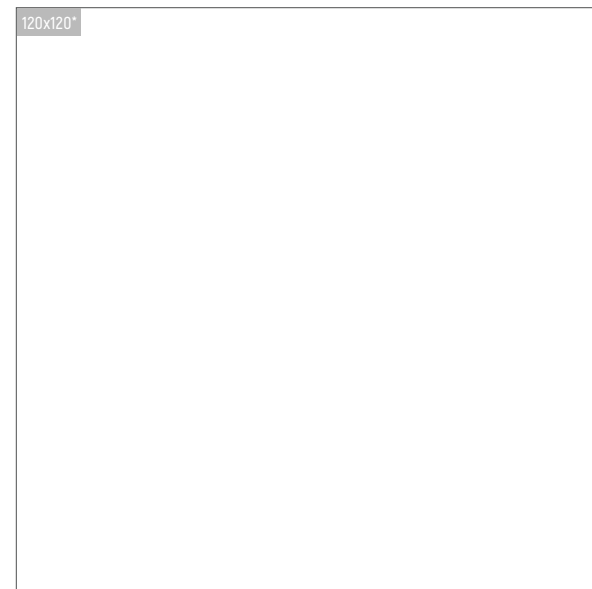

**120x120\***  
120 x 120 cm -  
47.2"x 47.2"

11 mm  
rectificado, rectified  
C-1/C-3

**60x120\***  
60 x 120 cm -  
23.6"x 47.2"

10,1 mm  
rectificado, rectified  
C-1/C-3

20 mm espesorado- 2 cm outdoor  
rectificado, rectified  
C-3

**14,5x120\***  
14,5 x 120 cm -  
5.7"x 47.2"

10,1 mm  
rectificado, rectified  
C-1

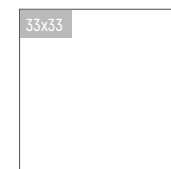

**33x66,5**  
33 x 66,5 cm -  
13.0"x 26.2"

10 mm  
C-3

**33x33**  
33 x 33 cm -  
13.0"x 13.0"

10 mm  
C-3

**16,25x33**  
16,25 x 33 cm -  
6.4"x 13.0"

10 mm  
C-3

**16,25x16,25**  
16,25 x 16,25 cm -  
6.4"x 6.4"

10 mm  
C-3

PIEZAS ESPECIALES · SPECIAL PIECES · PIÈCES SPÉCIALES · СПЕЦИАЛЬНЫЕ ЭЛЕМЕНТЫ



**PELDAÑO RECTO 120**  
33 x 120 x 3 cm - 13.0"x 47.2"x 1.2"

12 mm  
rectificado, rectified  
C-1/C-3



**REMATE PELDAÑO RECTO**  
3 x 33 cm - 1.2"x 13.0"



**PELDAÑO ML**  
33 x 33 x 4 cm - 13.0" x 13.0" x 1.6"

13 mm  
C-3



**CARTABÓN ML**  
33 x 33 x 4 cm - 13.0" x 13.0" x 1.6"

14 mm  
rectificado, rectified  
C-3



**ZANQUÍN INGLETADO RECTO**  
59,6 x 59,6 cm - 23.5"x 23.5"

11 mm

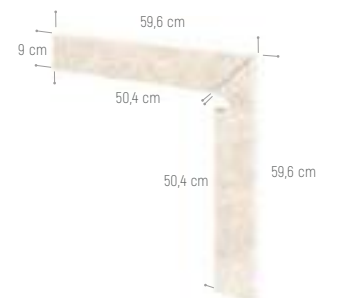

**ZANQUÍN INGLETADO ML IZDA/DCHA**  
59,6 x 59,6 cm - 23.5"x 23.5"

11 mm



**BORDE SKIMMER**  
45 x 75 x 3 cm - 17.7"x 29.5"x 1.2"

rectificado, rectified  
C-3



**RODAPIÉ**  
9 x 60 cm - 3.6"x 23.6"

11 mm

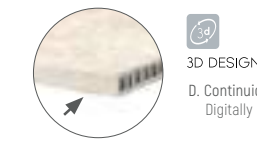

**3D DESIGN**  
D. Continuidad gráfica, parte trasera.  
Digitally printed, backside.

\* GRES PORCELÁNICO · PORCELAIN STONEWARE · GRÈS PORCELAINÉ · КЕРАМОГРАНИТ

# ARDENAS / MARFIL

exagres

TECHNICAL SOLUTIONS

INDOOR: ARDENAS MARFIL 60x120 CM [C-3] - BORDE SKIMMER 45x75x3 CM [C-3]

OUTDOOR: ARDENAS MARFIL 60x120 CM [C-3]



# ARDENAS / MARFIL

exagres

TECHNICAL SOLUTIONS

OUTDOOR: ARDENAS MARFIL 60x120 CM (C-3) - BORDE SKIMMER 45x75x3 CM (C-3) - PELDAÑO ML 33x33x4 CM (C-3) - CARTABÓN 33x33x4 CM (C-3)



# ARDENAS / MARFIL

ARDENAS MARFIL 120x120 CM [C-1] - PELDAÑO RECTO 33x120x3 CM [C-1] - TABICA 14,5x120 CM [C-1] - RODAPIÉ 9x60 CM - ZANQUÍN INGLETADO RECTO 59,6x59,6 CM





# ARDENAS / MARFIL

exagres

TECHNICAL SOLUTIONS

ARDENAS MARFIL 33x66,5 CM (C-3) - 33x33 CM (C-3) - 16,25x33 CM (C-3) - 16,25x16,25 CM (C-3) - BORDE SKIMMER 45x75x3 CM (C-3)



# ARDENAS / CROMO

exagres  
TECHNICAL SOLUTIONS

GRES EXTRUIDO · EXTRUDED KLINKER · GRÈS EXTRUDÉ · ЭКСТРУДИРОВАННЫЙ КЕРАМОГРАНИТ  
GRES PORCELÁNICO · PORCELAIN STONEWARE · GRÈS PORCELAINÉ · КЕРАМОГРАНИТ

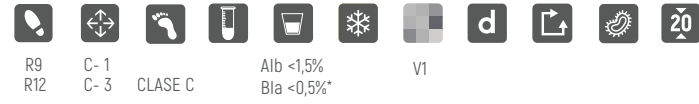

R9 R12 C-1 C-3 CLASE C Alb <1.5% Bla <0.5%\* V1

FORMATOS · SIZES · FORMATS · ФОРМАТЫ

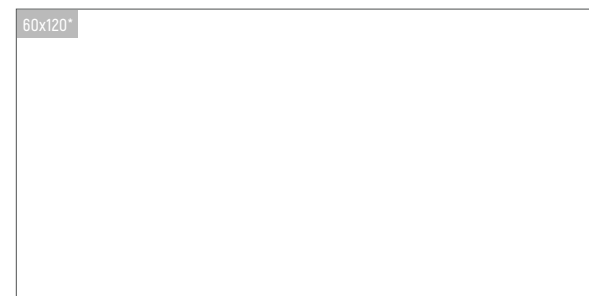
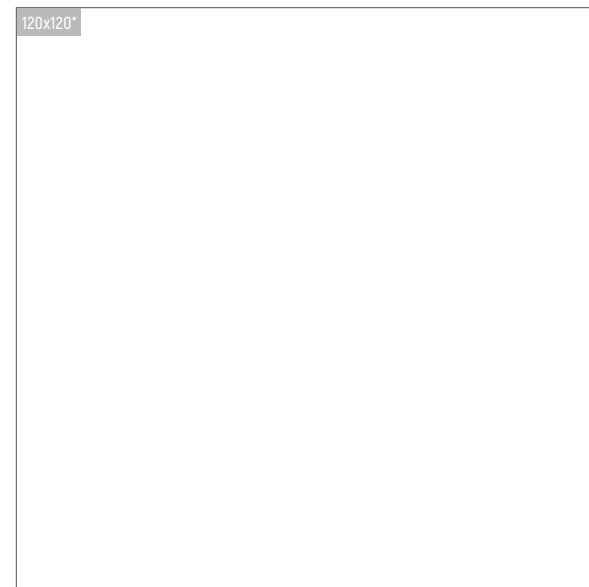

<p><b>120x120*</b> 120 x 120 cm - 47.2"x 47.2"</p> <p>11 mm rectificado, rectified C-1/C-3</p>	<p><b>60x120*</b> 60 x 120 cm - 23.6"x 47.2"</p> <p>10,1 mm rectificado, rectified C-1/C-3</p> <p>20 mm espesorado - 2 cm outdoor rectificado, rectified C-3</p>	<p><b>14,5x120*</b> 14,5 x 120 cm - 5.7"x 47.2"</p> <p>10,1 mm rectificado, rectified C-1</p>
--	--	---

\* GRES PORCELÁNICO · PORCELAIN STONEWARE · GRÈS PORCELAINÉ · КЕРАМОГРАНИТ

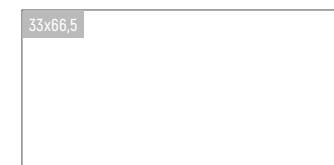
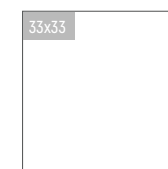

<p><b>33x66,5</b> 33 x 66,5 cm - 13.0"x 26.2"</p> <p>10 mm C-3</p>	<p><b>33x33</b> 33 x 33 cm - 13.0"x 13.0"</p> <p>10 mm C-3</p>	<p><b>16,25x33</b> 16,25 x 33 cm - 6.4"x 13.0"</p> <p>10 mm C-3</p>	<p><b>16,25x16,25</b> 16,25 x 16,25 cm - 6.4"x 6.4"</p> <p>10 mm C-3</p>
--	--	---	--

PIEZAS ESPECIALES · SPECIAL PIECES · PIÈCES SPÉCIALES · СПЕЦИАЛЬНЫЕ ЭЛЕМЕНТЫ



**PELDAÑO RECTO 120**  
33 x 120 x 3 cm - 13.0" x 47.2" x 1.2"  
12 mm  
rectificado, rectified  
C-1/C-3

**REMATE PELDAÑO RECTO**  
3 x 33 cm - 1.2" x 13.0"



**PELDAÑO ML**  
33 x 33 x 4 cm - 13.0" x 13.0" x 1.6"  
13 mm  
C-3



**CARTABÓN ML**  
33 x 33 x 4 cm - 13.0" x 13.0" x 1.6"  
14 mm  
rectificado, rectified  
C-3

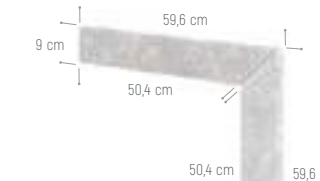

**ZANQUÍN INGLETADO RECTO**  
59,6 x 59,6 cm - 23.5" x 23.5"  
11 mm



**ZANQUÍN INGLETADO ML IZDA/DCHA**  
59,6 x 59,6 cm - 23.5" x 23.5"  
11 mm



**BORDE SKIMMER**  
45 x 75 x 3 cm - 17.7" x 29.5" x 1.2"  
rectificado, rectified  
C-3

**RODAPIÉ**  
9 x 60 cm - 3.6" x 23.6"  
11 mm



D. Continuidad gráfica, parte trasera.  
Digitally printed, backside.

# ARDENAS / CROMO



OUTDOOR: ARDENAS CROMO 120x120 CM (C-3) - PELDAÑO RECTO 33x120x3 CM (C-3) - TABICA 14,5x120 CM (C-1) - BORDE SKIMMER 45x75x3 CM (C-3) - ARDENAS GRIS 60x120 CM (C-1) -

PELDAÑO RECTO 33x120x3 CM (C-1)

INDOOR: ARDENAS CROMO 60x120 CM (C-1)



# ARDENAS / CROMO



OUTDOOR: ARDENAS CROMO 33x33 CM [C-3] - PELDAÑO ML 33x33x4 CM [C-3]

INDOOR: ARDENAS CROMO 60x120 CM [C-1]



# ARDENAS / CROMO

INDOOR: ARDENAS CROMO 120x120 CM [C-1] - PELDAÑO RECTO 120 - 33x120x3 CM [C-1] - TABICA 14,5x120 CM [C-1]

OUTDOOR: ARDENAS CROMO 60x120 CM [C-3] - ARDENAS CROMO 60x120 CM ESPESORADO [C-3]



# ARDENAS / GRIS

exagres  
TECHNICAL SOLUTIONS

GRES EXTRUIDO · EXTRUDED KLINKER · GRÈS EXTRUDÉ · ЭКСТРУДИРОВАННЫЙ КЕРАМОГРАНИТ  
GRES PORCELÁNICO · PORCELAIN STONWARE · GRÈS PORCELAINÉ · КЕРАМОГРАНИТ

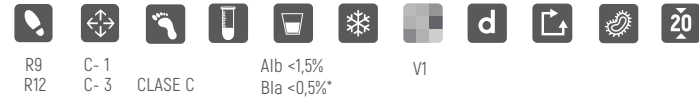

FORMATOS · SIZES · FORMATS · ФОРМАТЫ

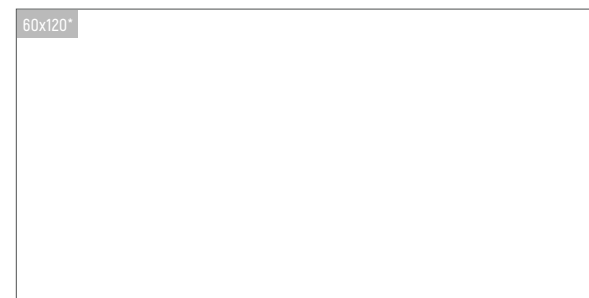
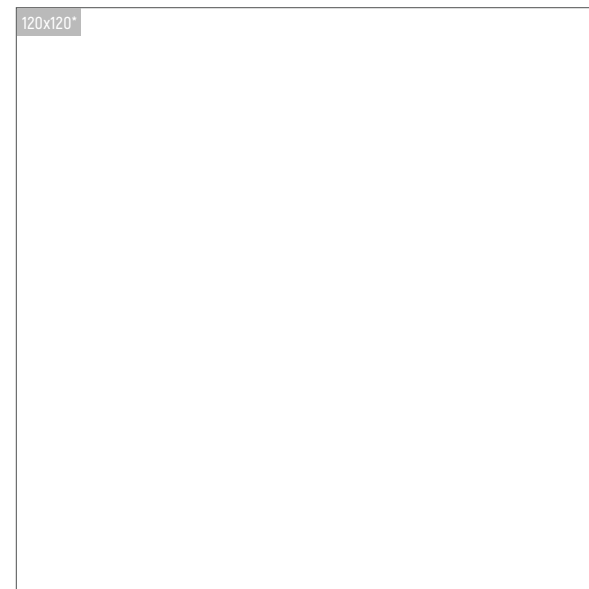

<p><b>120x120*</b> 120 x 120 cm - 47.2"x 47.2"</p> <p>11 mm rectificado, rectified C-1/C-3</p>	<p><b>60x120*</b> 60 x 120 cm - 23.6"x 47.2"</p> <p>10,1 mm rectificado, rectified C-1/C-3</p> <p>20 mm espesorado- 2 cm outdoor rectificado, rectified C-3</p>	<p><b>14,5x120*</b> 14,5 x 120 cm - 5.7"x 47.2"</p> <p>10,1 mm rectificado, rectified C-1</p>
--	---	---

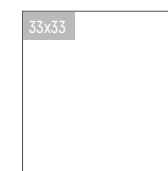

<p><b>33x66,5</b> 33 x 66,5 cm - 13.0"x 26.2"</p> <p>10 mm C-3</p>	<p><b>33x33</b> 33 x 33 cm - 13.0"x 13.0"</p> <p>10 mm C-3</p>	<p><b>16,25x33</b> 16,25 x 33 cm - 6.4"x 13.0"</p> <p>10 mm C-3</p>	<p><b>16,25x16,25</b> 16,25 x 16,25 cm - 6.4"x 6.4"</p> <p>10 mm C-3</p>
--	--	---	--

PIEZAS ESPECIALES · SPECIAL PIECES · PIÈCES SPÉCIALES · СПЕЦИАЛЬНЫЕ ЭЛЕМЕНТЫ



**PELDAÑO RECTO 120**  
33 x 120 x 3 cm - 13.0"x 47.2"x 1.2"

12 mm  
rectificado, rectified  
C-1/C-3

**REMATE PELDAÑO RECTO**  
3 x 33 cm - 1.2"x 13.0"



**PELDAÑO ML**  
33 x 33 x 4 cm - 13.0" x 13.0" x 1.6"

13 mm  
C-3



**CARTABÓN ML**  
33 x 33 x 4 cm - 13.0" x 13.0" x 1.6"

14 mm  
rectificado, rectified  
C-3

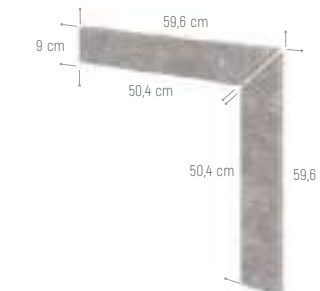

**ZANQUÍN INGLETADO RECTO**  
59,6 x 59,6 cm - 23.5"x 23.5"

11 mm



**ZANQUÍN INGLETADO ML IZDA/DCHA**  
59,6 x 59,6 cm - 23.5"x 23.5"

11 mm



**BORDE SKIMMER**  
45 x 75 x 3 cm - 17.7"x 29.5"x 1.2"

rectificado, rectified  
C-3

**RODAPIÉ**  
9 x 60 cm - 3.6"x 23.6"

11 mm



3D DESIGN  
D. Continuidad gráfica, parte trasera.  
Digitally printed, backside.



\*GRES PORCELÁNICO · PORCELAIN STONWARE · GRÈS PORCELAINÉ · КЕРАМОГРАНИТ

# ARDENAS / GRIS

OUTDOOR: ARDENAS GRIS 60x120 CM [C-3] - ARDENAS GRIS 120x120 CM [C-3] - PELDAÑO RECTO 33x120x3 CM [C-3] - TABICA 14,5x120 CM [C-1] - BORDE SKIMMER 45x75x3 CM [C-3]

ARDENAS ANTRACITA 60x120 CM [C-1]



# ARDENAS / GRIS

exagres  
TECHNICAL SOLUTIONS

ARDENAS GRIS 60x120 CM (C-1) - PELDAÑO RECTO 33x120x3 CM (C-1) - TABICA 14,5x120 CM (C-1) - ARDENAS ANTRACITA 60x120 CM (C-1)





# ARDENAS / GRIS

ARDENAS GRIS 120x120 CM (C-1) - PELDAÑO RECTO 120 - 33x120x3 CM (C-1) - TABICA 14,5x120 CM (C-1) - ARDENAS ANTRACITA 120x120 CM (C-1)

COSMOS CORTEN 120x120 CM (C-1)



# ARDENAS / ANTRACITA

exagres  
TECHNICAL SOLUTIONS

GRES EXTRUIDO · EXTRUDED KLINKER · GRÈS EXTRUDÉ · ЭКСТРУДИРОВАННЫЙ КЕРАМОГРАНИТ  
GRES PORCELÁNICO · PORCELAIN STONWARE · GRÈS PORCELAINÉ · КЕРАМОГРАНИТ



R9 C-1 Alb <1,5% V1  
R12 C-3 CLASE C Bla <0,5%\*

FORMATOS · SIZES · FORMATS · ФОРМАТЫ

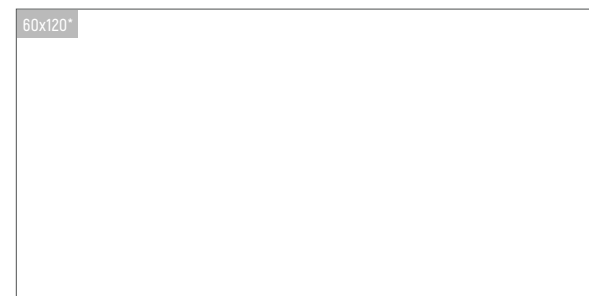
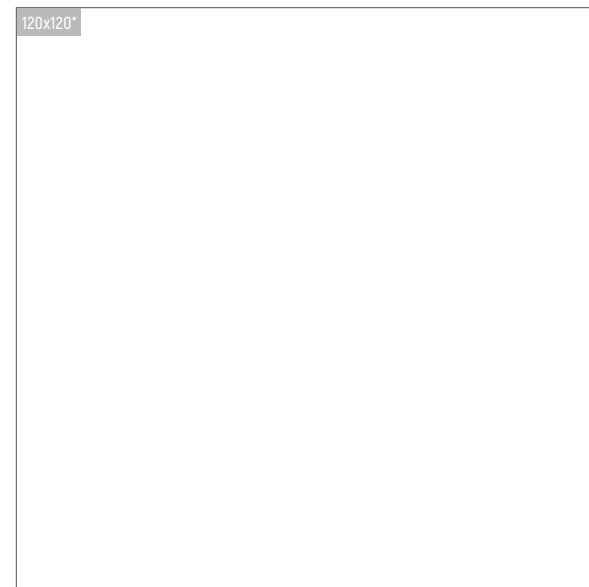

<p><b>120x120*</b> 120 x 120 cm - 47.2"x 47.2"</p> <p>11 mm rectificado, rectified C-1/C-3</p>	<p><b>60x120*</b> 60 x 120 cm - 23.6"x 47.2"</p> <p>10,1 mm rectificado, rectified C-1/C-3</p> <p>20 mm espesorado - 2 cm outdoor rectificado, rectified C-3</p>	<p><b>14,5x120*</b> 14,5 x 120 cm - 5.7"x 47.2"</p> <p>10,1 mm rectificado, rectified C-1</p>
--	--	---

\*GRES PORCELÁNICO · PORCELAIN STONWARE · GRÈS PORCELAINÉ · КЕРАМОГРАНИТ

16,25x16,25

16,25x33

33x33

33x66,5

<p><b>33x66,5</b> 33 x 66,5 cm - 13.0"x 26.2"</p> <p>10 mm C-3</p>	<p><b>33x33</b> 33 x 33 cm - 13.0"x 13.0"</p> <p>10 mm C-3</p>	<p><b>16,25x33</b> 16,25 x 33 cm - 6.4"x 13.0"</p> <p>10 mm C-3</p>	<p><b>16,25x16,25</b> 16,25 x 16,25 cm - 6.4"x 6.4"</p> <p>10 mm C-3</p>
--	--	---	--

PIEZAS ESPECIALES · SPECIAL PIECES · PIÈCES SPÉCIALES · СПЕЦИАЛЬНЫЕ ЭЛЕМЕНТЫ



**PELDAÑO RECTO 120**  
33 x 120 x 3 cm - 13.0" x 47.2" x 1.2"

12 mm  
rectificado, rectified  
C-1/C-3

**REMATE PELDAÑO RECTO**  
3 x 33 cm - 1.2" x 13.0"



**PELDAÑO ML**  
33 x 33 x 4 cm - 13.0" x 13.0" x 1.6"

13 mm  
C-3



**CARTABÓN ML**  
33 x 33 x 4 cm - 13.0" x 13.0" x 1.6"

14 mm  
rectificado, rectified  
C-3

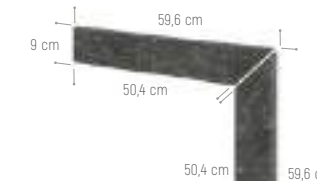

**ZANQUÍN INGLETADO RECTO**  
59,6 x 59,6 cm - 23.5" x 23.5"

11 mm



**ZANQUÍN INGLETADO ML IZDA/DCHA**  
59,6 x 59,6 cm - 23.5" x 23.5"

11 mm



**BORDE SKIMMER**  
45 x 75 x 3 cm - 17.7" x 29.5" x 1.2"

rectificado, rectified  
C-3

**RODAPIÉ**  
9 x 60 cm - 3.6" x 23.6"

11 mm



3D DESIGN  
D. Continuidad gráfica, parte trasera.  
Digitally printed, backside.



# ARDENAS / ANTRACITA

OUTDOOR: ARDENAS ANTRACITA 33x33 CM (C-3) - 16,25x33 CM (C-3) - 16,25x16,25 CM (C-3) - PELDAÑO ML 33x33x4 CM (C-3)

INDOOR: ARDENAS ANTRACITA 120x120 CM (C-1)



# ARDENAS / ANTRACITA

exagres

TECHNICAL SOLUTIONS

ARDENAS ANTRACITA 120x120 CM (C-1) - PELDAÑO RECTO 33x120x3 CM (C-1) - TABICA 14,5x120 CM (C-1) - LIZANA CEREZO 20x120 CM (C-1) - PELDAÑO RECTO 33x120x3 CM (C-1)



# ARDENAS / ANTRACITA

exagres

TECHNICAL SOLUTIONS

INDOOR: ARDENAS ANTRACITA 60x120 CM [C-1] - PELDAÑO RECTO 33x120x3 CM [C-1] - TABICA 14,5x120 CM [C-1] - COSMOS VENUS 120x120 CM [C-1]

OUTDOOR: ARDENAS ANTRACITA 60x120 CM [C-3]



# ARDENAS / ANTRACITA

exagres

TECHNICAL SOLUTIONS

INDOOR: ARDENAS ANTRACITA 60x120 CM [C-3] - BORDE SKIMMER 45x75x3 CM [C-3] - LIZANA HAYA 20x120 CM [C-1]

OUTDOOR: ARDENAS ANTRACITA 60x120 CM [C-3]



# ARDENAS / MARFIL / CROMO / GRIS / ANTRACITA



\* GRES PORCELÁNICO · PORCELAIN STONEWARE · GRÈS PORCELAINÉ · ΚΕΡΑΜΟΓΡΑΗΤ

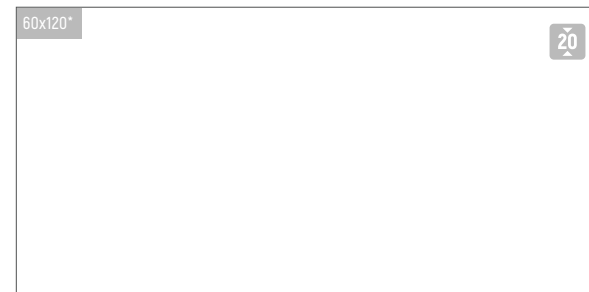

FORMATOS · SIZES · FORMATS · ΦΟΡΜΑΤΙ



60x120x2\*  
60 x 120 cm - 23.6"x 47.2"

-  20 mm **espesorado**- 2 cm outdoor
-  **rectificado**, rectified
-  C-3

\* GRES PORCELÁNICO · PORCELAIN STONEWARE · GRÈS PORCELAINÉ · ΚΕΡΑΜΟΓΡΑΗΤ





## VENTAJAS / ADVANTAGES · AVANTAGES · АДВАНТАЖИ



**Fácil instalación/**  
Easy installation · Installation facile · Простая установка



**Fácil limpieza/**  
Easy to clean · Nettoyage facile · Легкая очистка



**Antideslizante CLASE 3 - R 12/C**  
CLASS 3-R12 /C anti-slip properties · Antidérapant CLASSE 3 - R12/C · Коэффициент противоскольжения 3-R12/C



**Resistente al musgo y hongos/**  
Moss and fungus resistant · Résistant aux mousses et aux champignons · Устойчивость к мхам и грибкам



**Bajo coste de mantenimiento/**  
Low maintenance cost · Faible coût d'entretien · Низкая стоимость обслуживания



**Resistente a las manchas/**  
Stain resistant · Résistant aux taches · Устойчивость к пятнам



**Resistente a los cambios de temperatura/**  
Resistant to temperature changes · Résistant aux changements de température · Устойчивость к изменениям температуры



**Fácil sustitución de piezas/**  
Easy parts replacement · Remplacement facile des pièces · Простая замена деталей



**Resistente al rayado/**  
Scratch resistant · Résistant aux rayures · Устойчивость к царапинам



**Inalterable a la luz solar/**  
Unalterable to sunlight · Inaltérable au soleil · Не поддается воздействию солнечного света



**Resistente a las heladas/**  
Frost resistant · Résistant au gel · Морозостойкость



**Resistente a las sales, ácidos y químicos/**  
Resistant to salts, acids and chemicals · Résistant aux sels, aux acides et aux produits chimiques · Устойчивость к воздействию солей, кислот и химикатов



**Respetuoso con el medioambiente/**  
Environmentally friendly · Respect de l'environnement · Экологически чистый



**No necesita sellado/**  
No sealing required · Pas d'étanchéité requise · Уплотнение не требуется

## CARACTERÍSTICAS TÉCNICAS / TECHNICAL DATA · CARACTÉRISTIQUES TECHNIQUES · ТЕХНИЧЕСКИЕ ХАРАКТЕРИСТИКИ

NORMA TEST	DESCRIPCIÓN · DESCRIPTION	REQUISITOS · STANDARDS	VALOR MEDIO · AVERAGE VALUE
ISO 10545-2	Dimensiones / Sizes Longitud y anchura / Length and width Espesor / Thickness Rectitud de los lados / Straightness of sides Ortogonalidad / Rectangularity Planaridad / Surface Flatness	± 0,6% ± 2 mm ± 5,0% ± 0,5 mm ± 0,5% ± 1,5 mm ± 0,5% ± 2 mm ± 0,5% ± 2 mm	garantizado / guaranteed
ISO 10545-3	Absorción de agua / Water absorption	< 0,5 %	< 0,5 %
ISO 10545-4	Fuerza de rotura / Breaking strength	≥11.000 N	≥11.000 N
ISO 10545-4	Resistencia a la flexión / Modulus of rupture	≥ 35 N/mm <sup>2</sup>	> 35 N/mm <sup>2</sup>
ISO 10545-7	Resistencia a la abrasión superficial / Resistance to surface abrasion	1-5	4 marfil/cromo/gris 2 antracita
ISO 10545-9	Resistencia al choque térmico / Resistance to thermal shock	exigida / required	garantizado / guaranteed
ISO 10545-12	Resistencia a la helada / Frost resistance	exigida / required	garantizado / guaranteed
ISO 10545-13	Resistencia a los agentes químicos / Chemical resistance	mínimo B / minimum B	A-LA-HA
ISO 10545-14	Resistencia a las manchas / Stain resistance	mínimo clase 3 / minimum class3	clase 5 / class 5
UNE 41901 EX	Resistencia al deslizamiento (péndulo) / Slip Resistance (pendulum)	Exigida C.T.E. / C.T.E. required	CLASE 3 / CLASS 3
DIN 51130	Resistencia al deslizamiento (rampa pie calzado) / Anti-slip resistance (ramp)	-	R12
DIN 51097	Resistencia al deslizamiento (pie descalzo) / Anti-slip resistance (barefoot)	-	CLASE C / CLASS C

## USOS / USES · UTILISATIONS · ИСПОЛЬЗОВАНИЯ

**ÁMBITO RESIDENCIAL/**  
RESIDENTIAL SECTOR · SECTEUR RÉSIDENTIEL · ЖИЛОЙ СЕКТОР



**Jardines y patios**  
Gardens and courtyards · Jardins et cours · Сады и внутренние дворы



**Terrazas**  
Terraces · Terrasses · Террасы



**Piscinas**  
Swimming pools · Piscines · Плавательные бассейны



**Escaleras**  
Stairs · Escaliers · Лестницы

**ÁMBITO PÚBLICO/**  
PUBLIC SECTOR · SECTEUR PUBLIC · ОБЩЕСТВЕННЫЙ СЕКТОР



**Áreas públicas exteriores**  
Outdoor public areas · Espaces publics extérieurs · Открытые общественные зоны



**Restaurantes exteriores**  
Outdoor restaurants · Restaurants en plein air · Рестораны на открытом воздухе



**Bares y establecimientos de playa**  
Bars and beach establishments · Bars et établissements de plage · Бары и пляжные заведения



**Piscinas públicas**  
Public swimming pools · Piscines publiques · Общественные плавательные бассейны

## SISTEMAS DE COLOCACIÓN / PLACEMENT SYSTEMS · SYSTÈMES DE POSITIONNEMENT · СИСТЕМЫ ПОЗИЦИОНИРОВАНИЯ

**COLOCACIÓN SOBRE GRAVA O ARENA/**  
LAYING ON GRAVEL OR SAND · POSE SUR DU GRAVIER OU DU SABLE · УКЛАДКА НА ГРАВИЙ ИЛИ ПЕСОК



**COLOCACIÓN SOBRE PLOTS/**  
PLACEMENT ON PLOTS · PLACEMENT SUR PLOTS · РАЗМЕЩЕНИЕ НА УЧАСТКАХ



**COLOCACIÓN SOBRE CÉSPED/**  
LAYING ON GRASS · COUCHÉ SUR L'HERBE · ЛЕЖАТЬ НА ТРАВЕ



**COLOCACIÓN TRADICIONAL/**  
TRADITIONAL PLACEMENT · PLACEMENT TRADITIONNEL · ТРАДИЦИОННОЕ РАЗМЕЩЕНИЕ





ARDENAS CROMO 60x120 CM ESPESORADO (C-3) - BORDE SKIMMER 45x75x3 CM (C-3)



COLOCACIÓN EN PERÍMETROS/ PLACEMENT ON PERIMETERS -  
PLACEMENT SUR LES PÉRIMÈTRES - РАЗМЕЩЕНИЕ ПО ПЕРИМЕТРУ

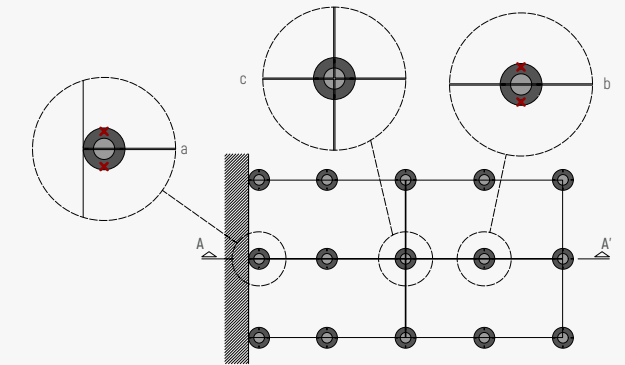

a-b. Corte 2 pestañas separadas/ Cut 2 separate tabs -  
Coupez 2 onglets séparés - Вырежьте 2 отдельные вкладки

c. Sin corte de pestañas separadas/ No cutting of separate eyelashes -  
Pas de coupe de cils séparés - Без подстригания отдельных ресниц

Sección vertical tipo A-A'/ Vertical section type A-A' -  
Section verticale de type A-A' - Тип вертикальной секции A-A'

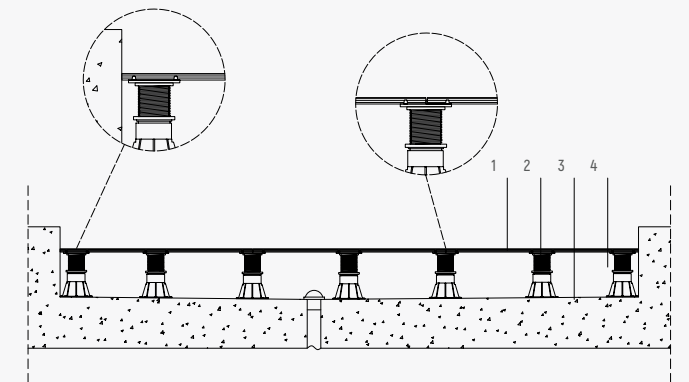

1. Baldosa cerámica 120x60 cm/Ceramic tile 120x60 cm - Carreau de céramique 120x60 cm -  
Керамическая плитка 120x60 см
2. Estructura elevada. PLOTS regulables/ Elevated structure, adjustable plots -  
Ouvrage surélevé, parcelles ajustables - Эстакадная конструкция, регулируемые участки
3. Formación de pendientes/ Slope formation - Formation de pente - формирование склона
4. Cámara de aire/ Air chamber - Chambre à air - Воздушная камера

POSICIÓN DE PLOTS/ PLOT POSITION - POSITION DU TRACÉ - ПОЗИЦИЯ УЧАСТКА

Uso privado/Private use -  
Usage privé/Частное использование

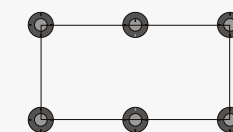

120x60 cm

Uso público/Public use -  
Usage public/Общественное использование

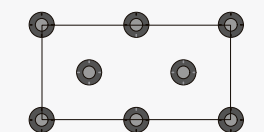

120x60 cm

# ARDENAS / MARFIL

exagres  
TECHNICAL SOLUTIONS

OUTDOOR: ARDENAS MARFIL 60x120 CM ESPESORADO (C-3) - PELDAÑO ML 33x33x4 CM (C-3) - CARTABÓN 33x33x4 CM (C-3)

INDOOR: ARDENAS MARFIL 60x120 CM (C-1)



# ARDENAS 20 / GRIS



OUTDOOR: ARDENAS GRIS 60x120 CM ESPESORADO [C-3] - PELDAÑO ML 33x33x4 CM [C-3] - CARTABÓN 33x33x4 CM [C-3] - ARDENAS GRIS 60x120 CM [C-3]

INDOOR: ARDENAS GRIS 60x120 CM [C-1]



STONE

# MILÁN

INSPIRED BY GEOLOGY  
IN&OUTDOOR  
STAIRS  
SWIMMINGPOOLS



ES / EN

COLORS:	SIZES (cm):	SIZES (inches):
ARENA	75x75 cm	29.5"x29.5"
GRIS	14,5x120 cm	5.7"x47.2"
MARENGO	33x33 cm	13.0"x13.0"

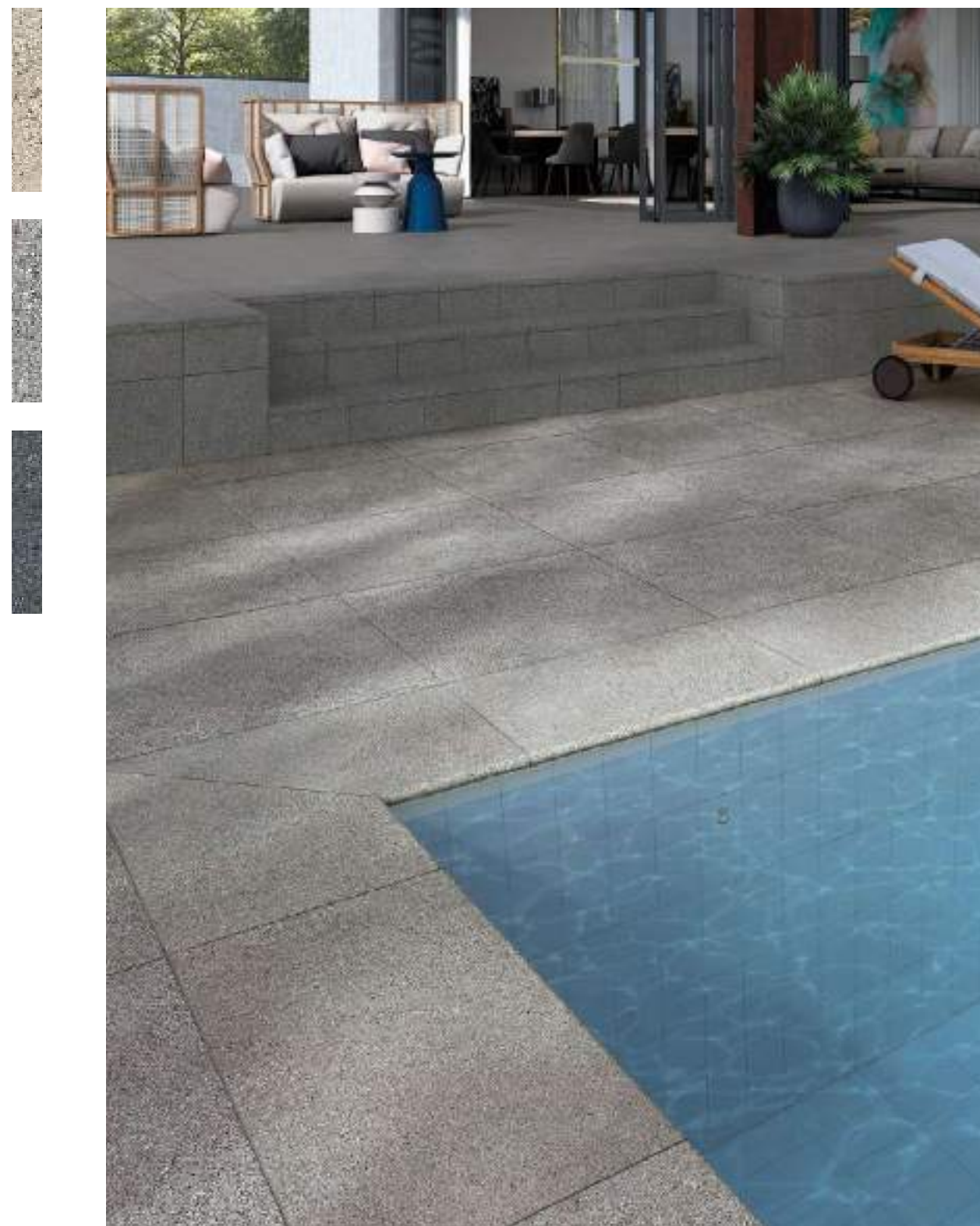

MILÁN GRIS 75x75 CM [C-3] - MILÁN MARENGO 33x33 CM [C-3] - BORDE SKIMMER MILÁN GRIS 45x75x3 CM [C-3] - MILÁN MARENGO PELDAÑO RECTO 33x33x3 CM [C-3]



R9 C-1 CLASE C Alb <1,5% Bla <0,5% V1

ARENA GRIS MARENGO



FORMATOS · SIZES · FORMATS · ФОРМАТЫ

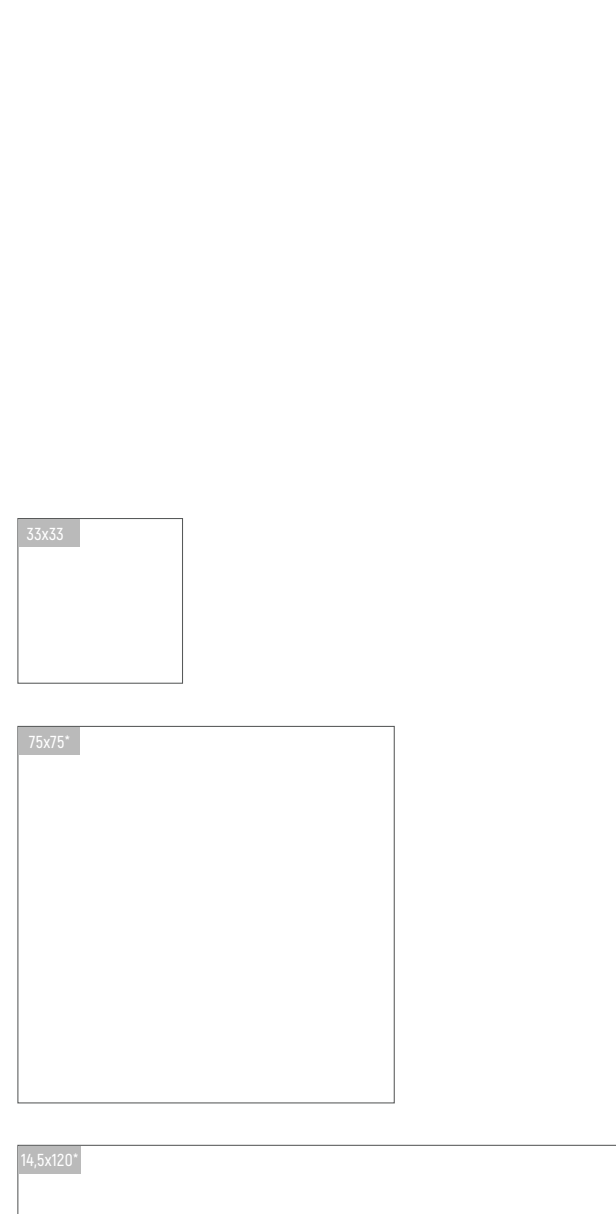

<p><b>75x75*</b> 75 x 75 cm - 29.5" x 29.5"</p> <p>± 9,5 mm rectificado, rectified C-1/C-3</p>	<p><b>14,5x120*</b> 14,5 x 120 cm - 5.7" x 47.2"</p> <p>± 10,1 mm rectificado, rectified C-1</p>	<p><b>33x33</b> 33 x 33 cm - 13.0" x 13.0"</p> <p>± 10 mm rectificado, rectified C-3</p>
--	--	--

\* GRES PORCELÁNICO · PORCELAIN STONEWARE · GRÈS PORCELAINÉ · КЕРАМОГРАНИТ

PIEZAS ESPECIALES · SPECIAL PIECES · PIÈCES SPÉCIALES · СПЕЦИАЛЬНЫЕ ЭЛЕМЕНТЫ



**PELDAÑO RECTO 120**  
33 x 120 x 3 cm - 13.0" x 47.2" x 1.2"

± 12 mm  
rectificado, rectified  
C-1/ C-3

**PELDAÑO RECTO**  
33 x 33 x 3 cm - 13.0" x 13.0" x 1.2"

± 12 mm  
rectificado, rectified  
C-3



**REMATE PELDAÑO RECTO**  
3 x 33 cm - 1.2" x 13.0"

**RODAPIÉ**  
9 x 60 cm - 3.6" x 23.6"

± 11 mm

**ZANQUÍN RECTO IZDA/DCHA**  
42,3 x 17,5 cm - 16.7" x 7.0"



**BORDE SKIMMER**  
45 x 75 x 3 cm - 17.7" x 29.5" x 1.2"

rectificado, rectified  
C-3

D. Continuidad gráfica, parte trasera.  
Graphic continuous, backside.



# MILÁN / GRIS

MILÁN GRIS 75x75 CM [C-3] - MILÁN MARENGO 33x33 CM [C-3] - BORDE SKIMMER MILÁN GRIS 45x75x3 CM [C-3] - MILÁN MARENGO PELDAÑO RECTO 33x33x3 CM [C-3]



# MILÁN / GRIS

exagres  
TECHNICAL SOLUTIONS

INDOOR: MILÁN GRIS 75x75 CM (C-1) - PELDAÑO RECTO 120 33x120x3 CM (C-1) - TABICA MILÁN GRIS 14,5x120 CM

OUTDOOR: MILÁN GRIS 33x33 CM (C-3)



# MILÁN / ARENA

INDOOR: MILÁN ARENA 75x75 CM [C-1]- PELDAÑO RECTO 120 33x120x3 CM [C-1] - TABICA MILÁN ARENA 14,5x120 CM





# MILÁN / ARENA

OUTDOOR: MILÁN ARENA / GRIS 33x33 CM (C-3) - PELDAÑO RECTO MILÁN ARENA 33x120x3 CM (C-3) - TABICA MILÁN ARENA 14,5x120 CM

INDOOR: MILÁN ARENA 75x75 CM (C-1) - PELDAÑO RECTO 33x120 CM (C-1)

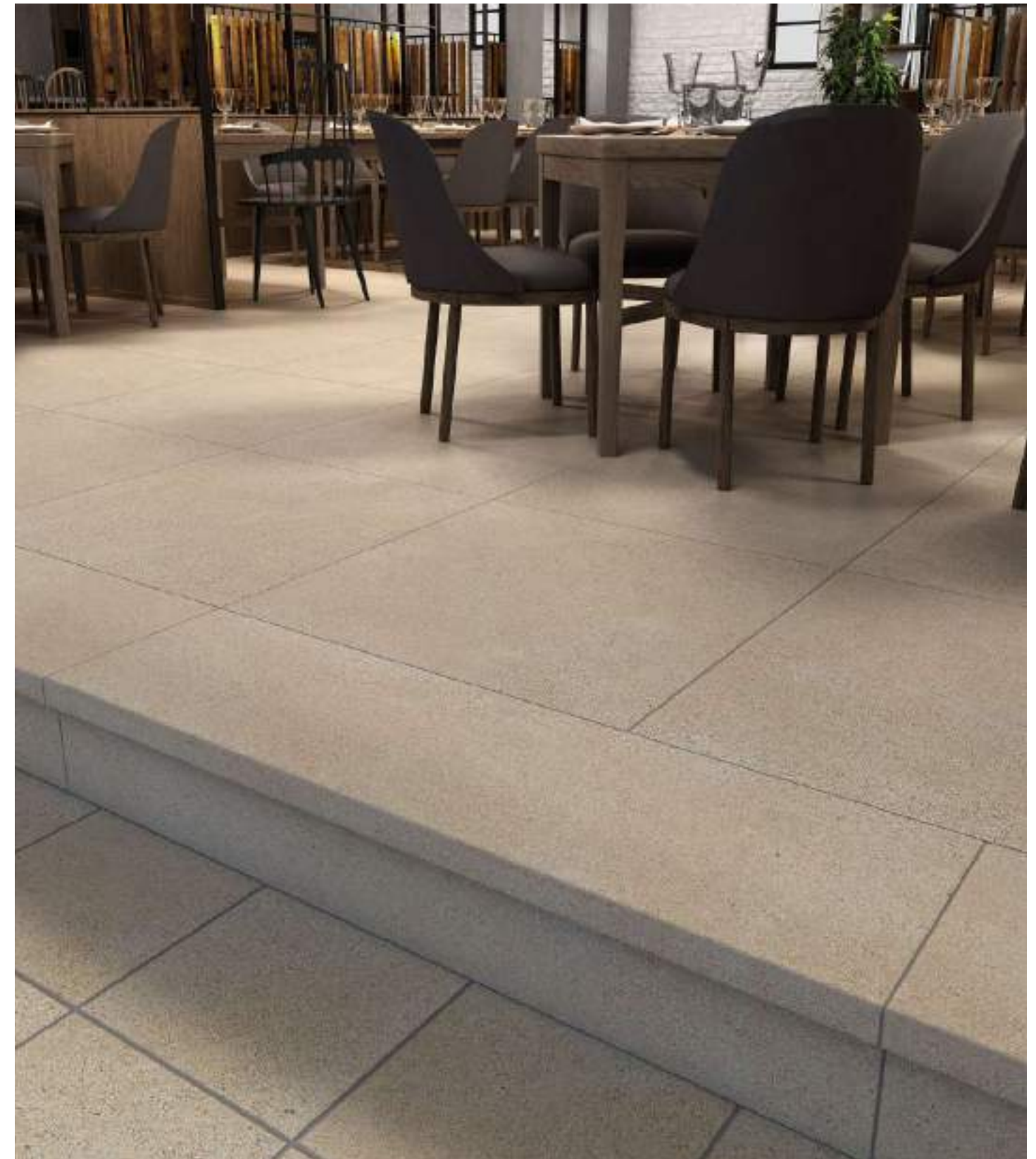

# MILÁN / MARENGO

exagres

TECHNICAL SOLUTIONS

OUTDOOR: MILÁN MARENGO 75x75 CM (C-3) - BORDE SKIMMER 45x75x3 CM (C-3) - PELDAÑO RECTO 33x120x3 CM (C-3)

INDOOR: MILÁN MARENGO 75x75 CM (C-1)



# MILÁN / MARENGO

exagres

TECHNICAL SOLUTIONS

INDOOR: MILÁN MARENGO 75x75 CM [C-1] - PELDAÑO RECTO 120 33x120x3 CM [C-1] - TABICA MILÁN MARENGO 14,5x120 CM

WALL: MANHATTAN RED 5,75x24,5 CM [C-2]



STONE

# ALBAROC

NATURAL STONE ESSENCE  
IN&OUTDOOR  
STAIRS  
SWIMMINGPOOLS



ES / EN

COLORS:	SIZES (cm):	SIZES (inches):
BOAL	100x100 cm	39.4"x39.4"
GALENA	14,5x120 cm	5.7"x47.2"
HULLA	33x66,5 cm	13.0"x26.2"
HULLA	33x33 cm	13.0"x13.0"



OUTDOOR: ALBAROC HULLA 33x66,5 CM [C-3] - PELDAÑO RECTO 33x120x3 CM [C-3]

INDOOR: ALBAROC HULLA 33x66,5 CM [C-1]

GRES EXTRUIDO · EXTRUDED KLINKER · GRÈS EXTRUDÉ · ЭКСТРУДИРОВАННЫЙ КЕРАМОГРАНИТ  
GRES PORCELÁNICO · PORCELAIN STONEWARE · GRÈS PORCELAINÉ · КЕРАМОГРАНИТ



R10 C-1 Alb <1,5% V2  
R12 C-3 Bla <0,5%

GALENA BOAL HULLA



FORMATOS · SIZES · FORMATS · ФОРМАТЫ

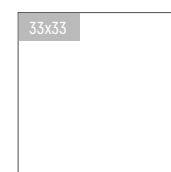
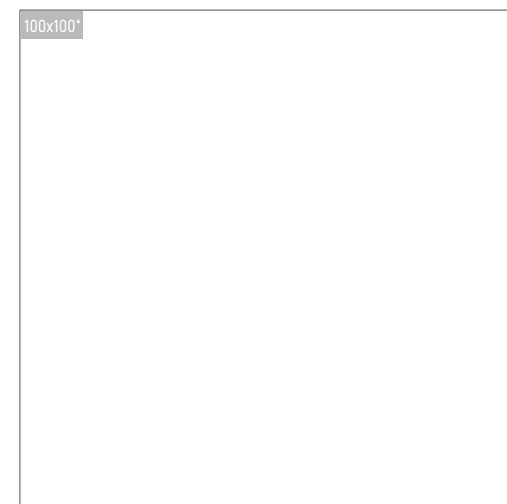

<b>100x100*</b> 100 x 100 cm - 39.4" x 39.4"	<b>14,5x120*</b> 14,5 x 120 cm - 5.7" x 47.2"	<b>33x66,5</b> 33 x 66,5 cm - 13.0" x 26.2"	<b>33x33</b> 33 x 33 cm - 13.0" x 13.0"
10 mm rectificado, rectified C-1/C-3	10,1 mm rectificado, rectified C-1	10 mm C-1/C-3	10 mm C-1/C-3

\* GRES PORCELÁNICO · PORCELAIN STONEWARE · GRÈS PORCELAINÉ · КЕРАМОГРАНИТ

PIEZAS ESPECIALES · SPECIAL PIECES · PIÈCES SPÉCIALES · СПЕЦИАЛЬНЫЕ ЭЛЕМЕНТЫ



**PELDAÑO RECTO 120**  
33 x 120 x 3 cm - 13.0" x 47.2" x 1.2"  
12 mm  
rectificado, rectified  
C-3



**REMATE PELDAÑO RECTO**  
3 x 33 cm - 1.2" x 13.0"



**PELDAÑO ML**  
33 x 33 x 4 cm - 13.0" x 13.0" x 1.6"  
13 mm  
C-3



**CARTABÓN ML**  
33 x 33 x 4 cm - 13.0" x 13.0" x 1.6"  
14 mm  
rectificado, rectified  
C-3



**RODAPIÉ**  
9 x 40 cm - 3.6" x 15.7"  
15 mm



**ZANQUÍN ML IZDA./DCHA.**  
18 x 40 cm - 7.1" x 15.7"  
15 mm



**ZANQUÍN RECTO IZDA./DCHA.**  
18 x 40 cm - 7.1" x 15.7"  
15 mm



**PASAMANOS 12°**  
12,5 x 66,5 x 4 cm - 4.9" x 26.2" x 1.6"



**PASAMANOS 15°**  
15,5 x 66,5 x 4 cm - 6.1" x 26.2" x 1.6"

\*medidas interiores. inner measures.

# ALBAROC / BOAL

OUTDOOR: ALBAROC BOAL 33x66,5 CM [C-3] - PASAMANOS 15,5x66,5x4 CM

INDOOR: ALBAROC BOAL 33x33 CM [C-1] - PELDAÑO ML 33x33x4 CM [C-3] - CARTABÓN ML 33x33x4 CM [C-3]



# ALBAROC / GALENA

INDOOR: ALBAROC GALENA 100x100 CM (C-1) - ALBAROC GALENA 14,5x120 (C-1) - PELDAÑO RECTO 33x120x3 CM (C-3) - REMATE PELDAÑO RECTO 3x33 CM

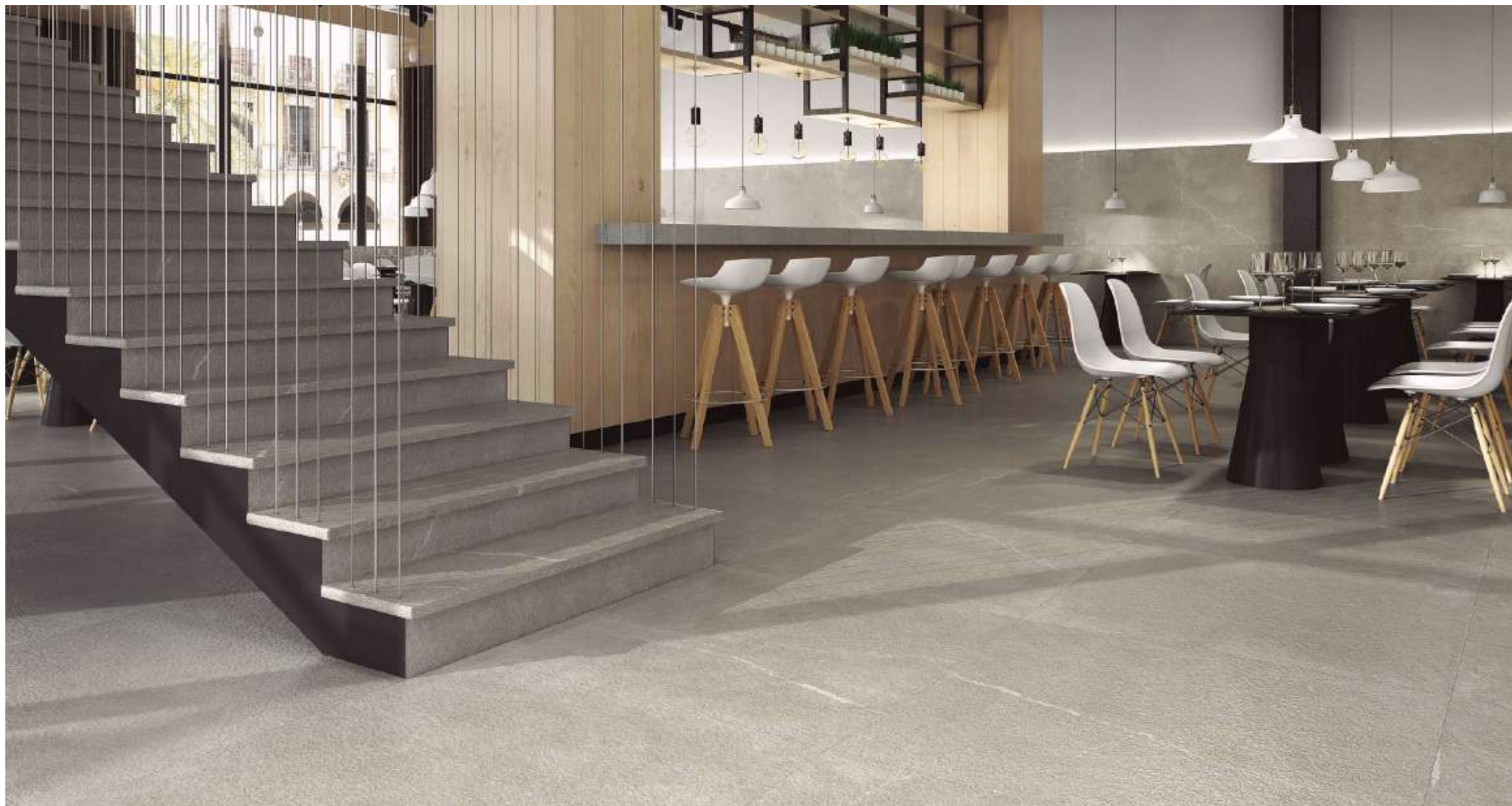

# ALBAROC / HULLA

OUTDOOR: ALBAROC HULLA 100x100 CM (C-3) - ALBAROC HULLA 14,5x120 CM (C-1) - PELDAÑO RECTO 33x120x3 CM (C-3) - PASAMANOS 15,5x66,5x4 CM





STONE

# LITOS

STONE & CEMENT FUSION  
IN&OUTDOOR  
STAIRS  
LARGE FORMATS  
SWIMMINGPOOLS



ES / EN

COLORS:	SIZES (cm):	SIZES (inches):
ÁRTICO	100x100 cm	39.4"x39.4"
SABANA	60x120 cm	23.6"x47.2"
SIBERIA	14,5x120 cm	5.7"x47.2"
	33x66,5 cm	13.0"x26.2"



LITOS SIBERIA 33x66,5 CM [C-1/C-3] - LITOS SIBERIA 14,5x120 CM [C-1] - LITOS SIBERIA 60x120 CM [C-3] - BORDE DESBORDANTE 28x66,5 CM [C-3] -  
ÁNGULO DESBORDANTE 33x33 CM [C-3] - REJILLA 24,5x24,5 CM [C-3] - ÁNGULO REJILLA IZDA. DCHA. 24,5x33 CM [C-3] - MEDIA CAÑA 33x4 CM - UÑA 4x4 CM

# LITOS /

GRES EXTRUIDO · EXTRUDED KLINKER · GRÈS EXTRUDÉ · ЭКСТРУДИРОВАННЫЙ КЕРАМОГРАНИТ  
GRES PORCELÁNICO · PORCELAIN STONWARE · GRÈS PORCELAINÉ · КЕРАМОГРАНИТ



R9 C-1 Alb <1.5% V2  
R12 C-3 CLASE C Bla <0.5%\*

ÁRTICO SABANA SIBERIA



FORMATOS · SIZES · FORMATS · ФОРМАТЫ

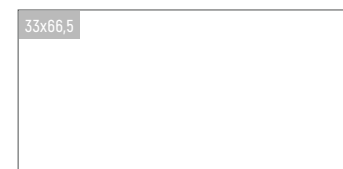
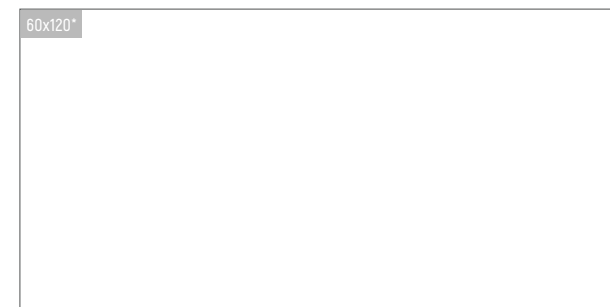
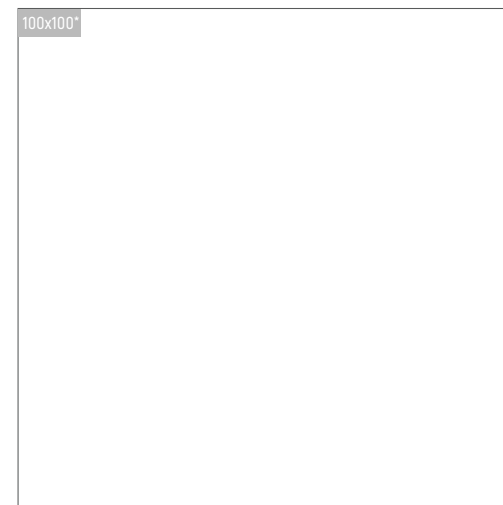

<b>100x100*</b> 100 x 100 cm - 39.4" x 39.4"	<b>60x120*</b> 60 x 120 cm - 23.6" x 47.2"	<b>14,5x120*</b> 14,5 x 120 cm - 5.7" x 47.2"	<b>33x66,5</b> 33 x 66,5 cm - 13.0" x 26.2"
± 10 mm	± 10,1 mm	± 10,1 mm	± 10 mm
rectificado, rectified	rectificado, rectified	rectificado, rectified	rectificado, rectified
C-1/C-3	C-1/C-3	C-1	C-1/C-3

\* GRES PORCELÁNICO · PORCELAIN STONWARE · GRÈS PORCELAINÉ · КЕРАМОГРАНИТ

# ÁRTICO / SABANA / SIBERIA



PIEZAS ESPECIALES · SPECIAL PIECES · PIÈCES SPÉCIALES · СПЕЦИАЛЬНЫЕ ЭЛЕМЕНТЫ



**PELDAÑO RECTO 120**  
33 x 120 x 3 cm - 13.0" x 47.2" x 1.2"  
± 12 mm  
rectificado, rectified  
C-3



**REMATE PELDAÑO RECTO**  
3 x 33 cm - 1.2" x 13.0"



**RODAPIÉ**  
9 x 40 cm - 3.6" x 15.7"  
± 15 mm



**ZANQUÍN RECTO**  
40 x 18 cm - 15.7" x 7.1"  
± 15 mm



**BORDE DESBORDANTE**  
28 x 66,5 cm - 11.0" x 26.2"  
rectificado, rectified  
C-3



**ÁNGULO DESBORDANTE**  
31 x 31 cm - 12.2" x 12.2"  
rectificado, rectified  
C-3



**REJILLA**  
24,5 x 24,5 cm - 9.6" x 9.6"  
rectificado, rectified  
C-3



**ÁNGULO REJILLA IZDA/DCHA\***  
24,5 x 33 cm - 9.6" x 13.0"  
rectificado, rectified  
C-3

\*set de 2 piezas [izda./dcha.] \*two pieces set [left/right]



**MEDIA CAÑA**  
33 x 4 cm - 13.0" x 1.6"  
r-3 cm



**UÑA**  
4 x 4 cm - 1.6" x 1.6"



**ARISTA**  
33 x 3 cm - 13.0" x 1.2"  
r-3 cm



**UÑA ARISTA**  
3 x 3 cm - 1.2" x 1.2"

# LITOS / ÁRTICO

exagres

TECHNICAL SOLUTIONS

OUTDOOR: LITOS ÁRTICO 60x120 CM (C-3)

INDOOR: LITOS ÁRTICO 60x120 CM (C-3) / 33x66,5 CM (C-1) / 14,5x120 CM (C-1) - BORDE DESBORDANTE 28x66,5 CM (C-3) - ÁNG. DESBORDANTE 33x33 CM (C-3) - REJILLA 24,5x24,5 CM (C-3) - ÁNGULOS REJILLA 24,5x33 CM (C-3) - MEDIA CAÑA 33x4 CM - UÑA 4x4 CM



# LITOS / SABANA

exagres

TECHNICAL SOLUTIONS

OUTDOOR: LITOS SABANA 33x66,5 CM (C-3) / 14,5x120 CM (C-1) - PELDAÑO RECTO 33x120x3 CM (C-3) - BORDE DESBORDANTE 28x66,5 CM (C-3) - ÁNGULO DESBORDANTE 33x33 CM (C-3)

REJILLA 24,5x24,5 CM (C-3) - ÁNGULOS REJILLA 24,5x33 CM (C-3) - LITOS SABANA 33x66,5 CM (C-1)

INDOOR: LITOS SABANA 60x120 CM (C-1)



# LITOS / SIBERIA

INDOOR: LITOS SIBERIA 100x100 CM (C-1) / 60x120 CM (C-1) / 14,5x120 CM (C-1) - PELDAÑO RECTO 33x120x3 CM (C-3) - REMATE PELDAÑO RECTO 3x33 CM



# MANHATTAN

TRENDS AND TECHNICAL  
SOLUTIONS IN EXTRUDED  
BRICK  
SMALL FORMAT  
STAIRS



ES



EN



FR

COLORS:	SIZES (cm):	SIZES (inches):
WHITE		
GREY	24,5x24,5 cm	9.6"x9.6"
MINK	12x24,5 cm	4.7"x9.6"
RED	5,75x24,5 cm	2.3"x9.6"



OUTDOOR: MANHATTAN GREY 24,5x24,5 CM ( C-2) - FAÇADE: MANHATTAN GREY 5,75x24,5 CM (C-2)

# MANHATTAN /

GRES EXTRUIDO · EXTRUDED KLINKER · GRÈS EXTRUDÉ · ЭКСТРУДИРОВАННЫЙ КЕРАМОГРАНИТ

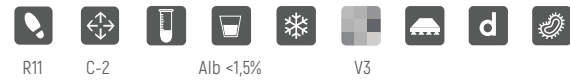

WHITE

GREY

MINK

RED

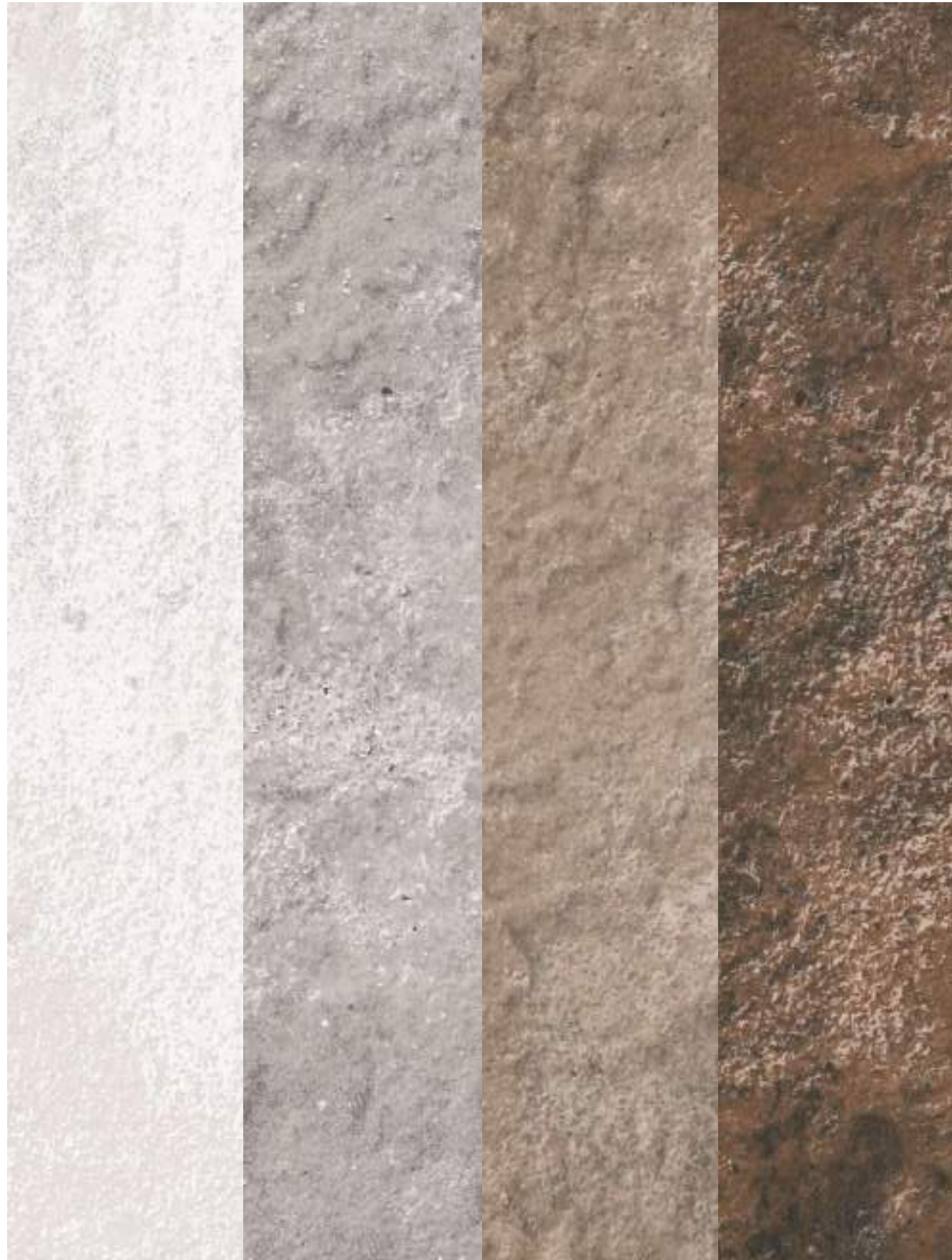

# WHITE / GREY / MINK / RED



FORMATOS · SIZES · FORMATS · ФОРМАТЫ

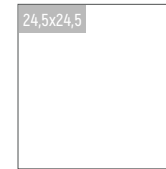

**24,5x24,5**  
24,5 x 24,5 cm - 9.6"x 9.6"  
± 9 mm  
C-2



**12x24,5**  
12 x 24,5 cm - 4.7"x 9.6"  
± 9 mm  
C-2



**5,75x24,5\***  
5,75 x 24,5 cm - 2.3"x9.6"  
± 9 mm  
C-2

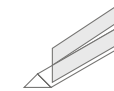

\*El brick 5,75x24,5 se consigue de la plaqueta doble de precorte que se separa en obra.  
The 5,75 x 24,5 brick is achieved from the double pre-cut plate that is separated on site.  
Le brick 5,75 x 24,5 s'obtient par la double plaquette de pré-découpage qui se sépare en construction.  
Плитка 5,75 x 24,5 см получается из двойной пластины с предварительно сделанным пазом, которая разделяется при выполнении облицовочных работ.

PIEZAS ESPECIALES · SPECIAL PIECES · PIÈCES SPÉCIALES · СПЕЦИАЛЬНЫЕ ЭЛЕМЕНТЫ



**PELDAÑO ML**  
24,5 x 33 x 4 cm - 9.6"x 13.0"x1.6"  
± 13 mm  
C-2



**CARTABÓN ML**  
33 x 33 x 4 cm - 13.0"x 13.0"x1.6"  
± 14 mm  
C-2  
rectificado, rectified



**ZANQUIN ML IZDA./DCHA.**  
39,5 x 17,5 cm - 15.6"x 6.9"  
± 7,5 mm



**RODAPIÉ**  
9 x 24,5 cm - 3.6"x 9.6"  
± 11 mm



**VIERTEAGUAS**  
15 x 24,5 x 4 cm - 5.9"x9.6"x1.6"  
± 10 mm

# MANHATTAN / WHITE

INDOOR: MANHATTAN WHITE 24,5x24,5 CM - MANHATTAN WHITE 12x24,5 CM - MANHATTAN WHITE 5,75x24,5 CM



# MANHATTAN / GREY

OUTDOOR: MANHATTAN GREY 24,5x24,5 CM - PELDAÑO ML 24,5x33x4 CM - CARTABÓN ML 33x33x4 CM - VIERTEAGUAS 15x24,5x4 CM





# MANHATTAN / MINK

INDOOR: MANHATTAN MINK 12x24,5 CM - MANHATTAN MINK 5,75x24,5 CM - PELDAÑO ML 24,5x33x4 CM - CARTABÓN ML 33x33x4 CM



# MANHATTAN / RED

OUTDOOR: MANHATTAN RED 24,5x24,5 CM / 12x24,5 CM / 5,75x24,5 CM - VIERTEAGUAS 15x24,5x4 CM FAÇADE: MANHATTAN RED 24,5x24,5 CM - 12x24,5 CM

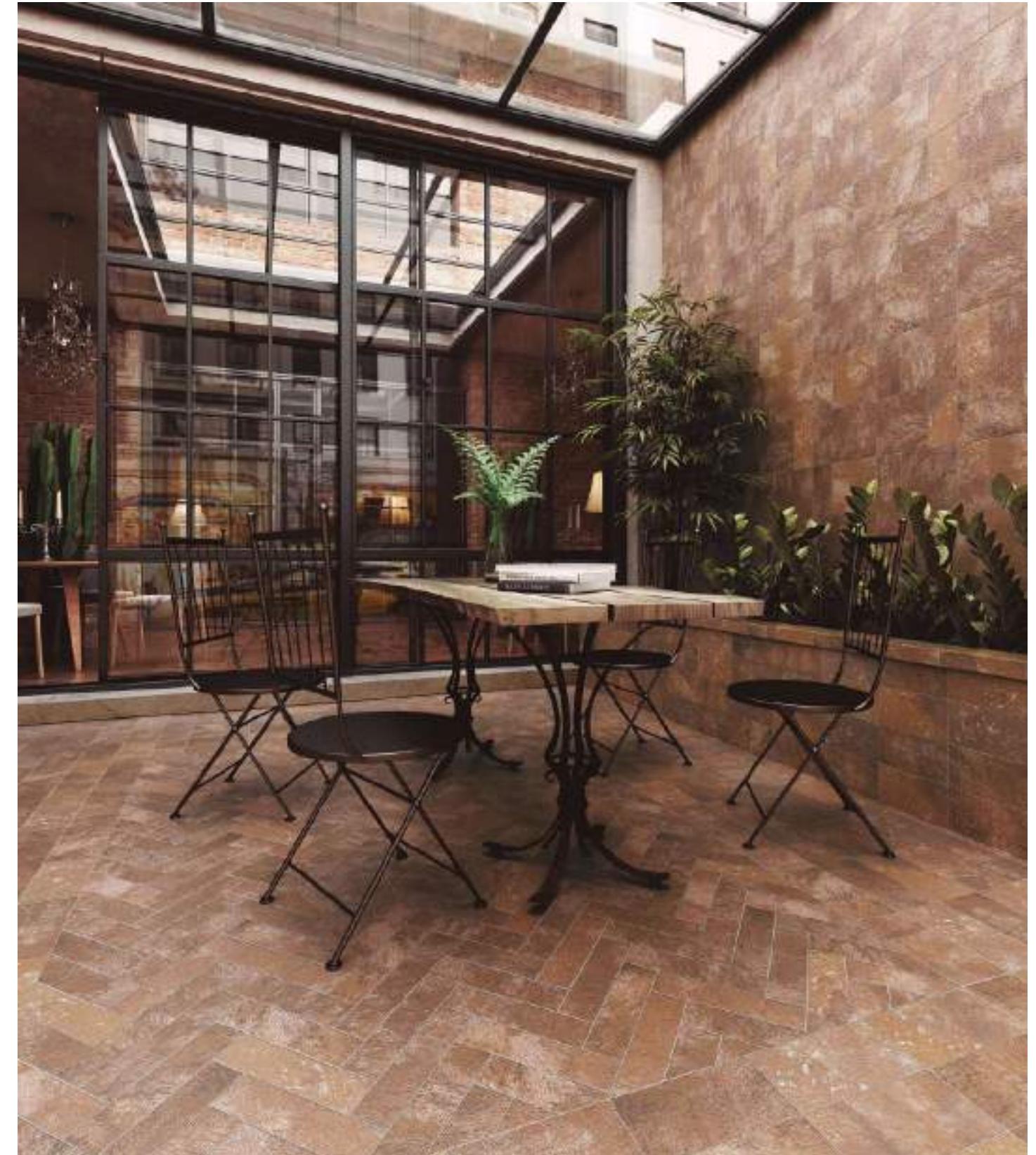

STONE

# PETRA

STONE GRAPH EXTRUDED  
STAIRS  
SWIMMINGPOOLS



ES



EN



FR

COLORS:      SIZES (cm):      SIZES (inches):

BONE  
OCRE  
GRIS      33x33 cm      13.0"x13.0"

exagres

TECHNICAL SOLUTIONS



PETRA GRIS 33x33 CM [C-3] - BORDE PISCINA 28x33 CM [C-3] - ÁNG. INTERIOR PISCINA 33x33 CM [C-3] - PELDAÑO FIORENTINO 33x33x3 CM [C-3]

# PETRA /

GRES EXTRUIDO · EXTRUDED KLINKER · GRÈS EXTRUDÉ · ЭКСТРУДИРОВАННЫЙ КЕРАМОГРАНИТ

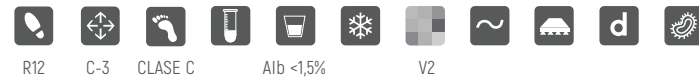

BONE

OCRE

GRIS



# BONE / OCRE / GRIS

FORMATOS · SIZES · FORMATS · ФОРМАТЫ

DECORADOS · DECORS · DÉCORÉ · УКРАШЕН



**TABICA PETRA ETNA**  
15 x 33 cm - 5.9"x 13.0"

± 10 mm



**TACO PETRA ETNA**  
8 x 8 cm - 3.15"x 3.15"

± 10 mm

PIEZAS ESPECIALES · SPECIAL PIECES · PIÈCES SPÉCIALES · СПЕЦИАЛЬНЫЕ ЭЛЕМЕНТЫ



**PELDAÑO FIORENTINO**  
33 x 33 x 3 cm - 13.0"x 13.0"x 1.2"

± 12 mm  
C-3



**CARTABÓN FIORENTINO**  
33 x 33 x 3 cm - 13.0"x 13.0"x 1.2"

± 14 mm  
C-3  
rectificado, rectified

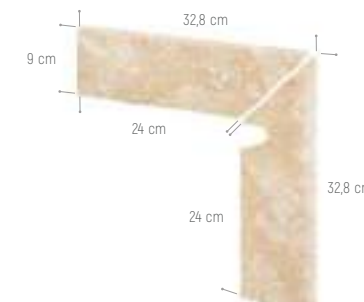

**ZANQUÍN FIORENTINO IZDA/DCHA\***  
32,8 x 32,8 cm - 12.9"x 12.9"

± 11 mm

\*colores bone y ocre. bone and ocre colors.



**ZANQUIN FIORENTINO IZDA./DCHA\***  
39,5 x 17,5 cm - 15.6"x 6.9"

± 7,5 mm

\*sólo color gris. only gris color.



**RODAPIÉ**  
9 x 33 cm - 3.6"x 13.0"

± 11 mm

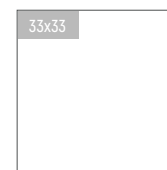

**33x33**  
33 x 33 cm - 13.0"x 13.0"

± 10 mm  
C-3



**BORDE PISCINA**  
28 x 33 cm - 11.0"x 13.0"

C-3



**ÁNGULO INTERIOR PISCINA**  
33 x 33 cm - 13.0"x 13.0"

C-3  
rectificado, rectified



**ÁNGULO EXTERIOR PISCINA**  
28 x 28 cm - 11.0"x 11.0"

C-3  
rectificado, rectified

# PETRA / BONE

OUTDOOR: PETRA BONE 33x33 CM (C-3)



# PETRA / GRIS

OUTDOOR: PETRA GRIS 33x33 CM (C-3)



STONE

# VEGA

SOFT STONE WITH RELIEF  
INDOOR  
STAIRS



ES



EN



FR

COLORS:

VISÓN  
GRIS  
ROJO  
OCRE

SIZES (cm):

33x33 cm

SIZES (inches):

13.0"x13.0"

exagres

TECHNICAL SOLUTIONS



VEGA OCRE 33x33 CM (C-1) - RODAPIÉ 9x33 CM

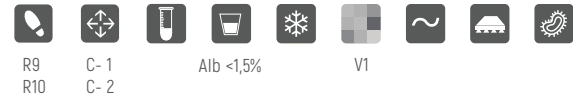

VISÓN

GRIS

ROJO

OCRE



FORMATOS · SIZES · FORMATS · ФОРМАТЫ

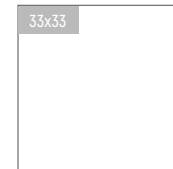

**33x33**  
33 x 33 cm - 13.0" x 13.0"  
± 10 mm  
C-1 / C-2

PIEZAS ESPECIALES · SPECIAL PIECES · PIÈCES SPÉCIALES · СПЕЦИАЛЬНЫЕ ЭЛЕМЕНТЫ

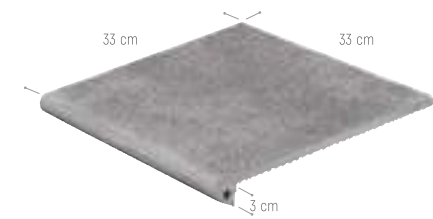

**PELDAÑO FIORENTINO**  
33 x 33 x 3 cm - 13.0" x 13.0" x 1.2"  
± 12 mm  
C-1/C-2

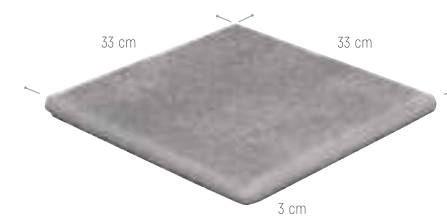

**CARTABÓN FIORENTINO**  
33 x 33 x 3 cm - 13.0" x 13.0" x 1.2"  
± 14 mm  
C-1/C-2  
rectificado. rectified

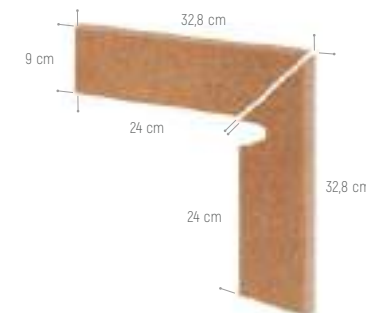

**ZANQUÍN FIORENTINO IZDA./DCHA\***  
32,8 x 32,8 cm - 12.9" x 12.9"  
± 11 mm

\*sólo color rojo. only rojo color.



**ZANQUIN FIORENTINO IZDA./DCHA.**  
39,5 x 17,5 cm - 15.6" x 6.9"  
± 7,5 mm



**RODAPIÉ**  
9 x 33 cm - 3.6" x 13.0"  
± 11 mm



**VIERTEAGUAS**  
12 x 33 x 3cm - 3.6" x 13.0" x 1.2"  
± 12 mm

\*colores ocre, visón y gris. ocre, visón and gris colors.

# ALHAMAR

THE AGEING EFFECT OF NATURAL CLAY  
IN&OUTDOOR  
MULTIFORMAT  
STAIRS  
DECORS



ES



EN



FR

COLORS:	SIZES (cm):	SIZES (inches):
BLANCO	33x33 cm	13.0"x13.0"
PAJA	16,25x33 cm	6.4"x13.0"
SALMÓN	16,25x33 cm	6.4"x13.0"
ROJO	16,25x16,25 cm	6.4"x6.4"



OUTDOOR: ALHAMAR BLANCO 33x33 CM [C-3] - PELDAÑO FIORENTINO BLANCO 33x33x3 CM [C-3]

INDOOR: ALHAMAR BLANCO 33x33 CM [C-1]



R9  
R12

C-1  
C-3

Alib <1,5%

V3

BLANCO PAJA SALMÓN ROJO



FORMATOS · SIZES · FORMATS · ФОРМАТЫ

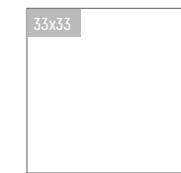

**33x33**  
33 x 33 cm -  
13.0" x 13.0"

10 mm  
C-1 / C-3

**16,25x33**  
16,25 x 33 cm -  
6.4" x 13.0"

10 mm  
C-3

**16,25x16,25**  
16,25 x 16,25 cm -  
6.4" x 6.4"

10 mm  
C-3

DECORADOS · DECORATED · DÉCORÉ · УКРАШЕН



**DECORATIVE**  
33 x 33 cm - 13.0" x 13.0"

10 mm  
C-3



\*1 set 4 piezas - 4 pieces pack



**CLAY**  
33 x 33 cm - 13.0" x 13.0"

10 mm  
C-3



\*1 set 2 piezas - 2 pieces pack



**TABICA CLAY**  
15 x 33 cm - 5.9" x 13.0"

10 mm  
C-3



\*1 set 2 piezas - 2 pieces pack

PIEZAS ESPECIALES · SPECIAL PIECES · PIÈCES SPÉCIALES · СПЕЦИАЛЬНЫЕ ЭЛЕМЕНТЫ

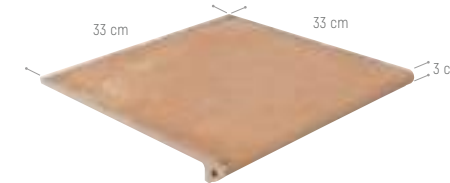

**PELDAÑO FIORENTINO**  
33 x 33 x 3 cm - 13.0" x 13.0" x 1.2"

12 mm  
C-3

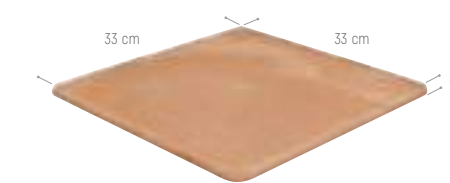

**CARTABÓN FIORENTINO**  
33 x 33 x 3 cm - 13.0" x 13.0" x 1.2"

14 mm  
C-3  
rectificado, rectified

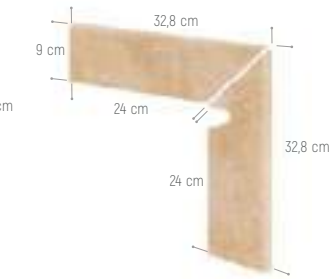

**ZANJAQUÍN INGLETADO FIORENTINO IZDA./DCHA\***  
32,8 x 32,8 cm - 12.9" x 12.9"

11 mm \*sólo color paja, only paja color.



**RODAPIÉ**  
9 x 33 cm - 3.5" x 13.0"

11 mm



**ZANJAQUÍN FIORENTINO IZDA./DCHA\***  
39,5 x 17,5 cm - 15.6" x 6.9"

7,5 mm  
\*colores blanco, salmón y rojo.  
blanco, salmón and rojo colors.

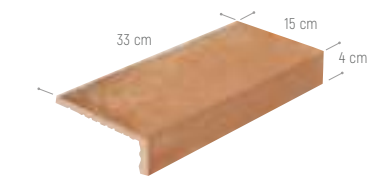

**VIERTEAGUAS**  
15 x 33 x 4 cm - 5.9" x 13.0" x 1.6"

10 mm  
C-3



# ALHAMAR / SALMÓN

OUTDOOR: ALHAMAR SALMÓN 33x33 CM (C-3) / 16,25x33 CM (C-3) - PELDAÑO FIORENTINO 33x33x3 CM (C-3) - CARTABÓN FIORENTINO 33x33x3 CM



# ALHAMAR / ROJO

INDOOR: ALHAMAR ROJO 33x33 CM (C-1) - DECORATIVE ROJO 33x33 CM (C-3)



OUTDOOR: ALHAMAR ROJO 33x33 CM (C-3) - VIERTEGUAS 15x33x4 CM

METAL

# METÁLICA

DESIGN AND METALLIC EFFECTS  
INDOOR  
STAIRS



ES



EN



FR

COLORS:	SIZES (cm):	SIZES (inches):
PURPLE		
CHERRY		
BASALT		
VULCANO	33x33 cm	13.0"x13.0"



INDOOR: METÁLICA VULCANO 33x33 CM - PELDAÑO FIORENTINO 33x33x3 CM

# METÁLICA /

GRES EXTRUIDO · EXTRUDED KLINKER · GRÈS EXTRUDÉ · ЭКСТРУДИРОВАННЫЙ КЕРАМОГРАНИТ

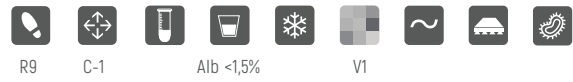

VULCANO

CHERRY

BASALT

PURPLE



# VULCANO / CHERRY / BASALT / PURPLE



FORMATOS · SIZES · FORMATS · ФОРМАТЫ

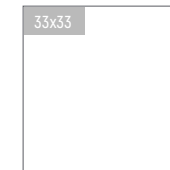

**33x33**  
33 x 33 cm - 13.0" x 13.0"  
± 10 mm  
C-1

PIEZAS ESPECIALES · SPECIAL PIECES · PIÈCES SPÉCIALES · СПЕЦИАЛЬНЫЕ ЭЛЕМЕНТЫ



**PELDAÑO FIORENTINO**  
33 x 33 x 3 cm - 13.0" x 13.0" x 1.2"  
± 12 mm  
C-1



**CARTABÓN FIORENTINO**  
33 x 33 x 3 cm - 13.0" x 13.0" x 1.2"  
± 14 mm  
rectificado, rectified  
C-1



**ZANQUIN FIORENTINO IZDA./DCHA.**  
39,5 x 17,5 cm - 15.6" x 6.9"  
± 7,5 mm



**RODAPIÉ**  
9 x 33 cm - 3.6" x 13.0"  
± 11 mm

# METÁLICA / VULCANO

INDOOR: METÁLICA PURPLE 33x33 CM (C-1) - PELDAÑO FIORENTINO 33x33x3 CM





MANHATTAN

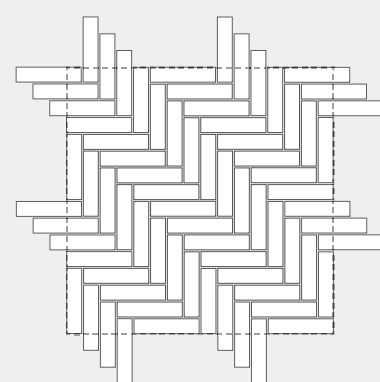

1 m<sup>2</sup>

5,75 x 24,5 cm | 76 uds/m<sup>2</sup>



ARDENAS

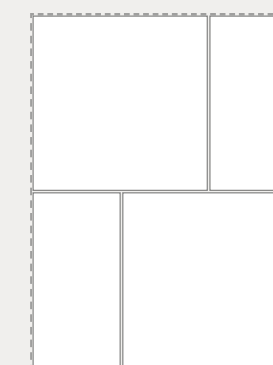

3,24 m<sup>2</sup>

120 x 120 cm | 2 piezas. pieces  
60 x 120 cm | 2 piezas. pieces



ALHAMAR

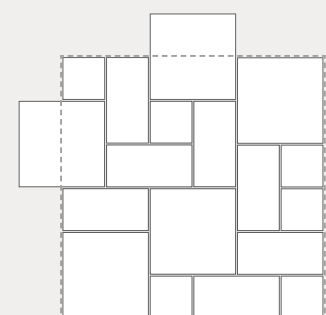

1 m<sup>2</sup>

33 x 33 cm | 5 piezas. pieces  
16,25 x 33 cm | 7 piezas. pieces  
16,25 x 16,25 cm | 6 piezas. pieces



ARDENAS

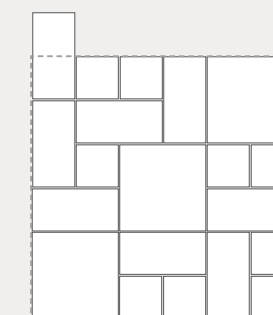

1 m<sup>2</sup>

33 x 33 cm | 3 piezas. pieces  
16,25 x 33 cm | 7 piezas. pieces  
16,25 x 16,25 cm | 9 piezas. pieces

Exagres se caracteriza por ofrecer una amplia gama de producto conformado mediante extrusión, con elevadas características técnicas, ideales tanto para el interior como el exterior de la vivienda, además de poderse dirigir a espacios públicos y privados.

Con el proceso de extrusión se consiguen piezas con determinadas geometrías y secciones complejas imposibles de alcanzar mediante el prensado, dando así soluciones completas para recubrimientos integrales y homogéneos con un mismo material cerámico.

Todo esto unido con la tecnología de impresión digital, que permite decorar con cualquier diseño la pieza cerámica por completo, desde los bajos relieves hasta los diferentes planos que ofrecen nuestras piezas, hace que Exagres pueda ofrecer un producto único y de calidad superior tanto técnica como estéticamente.

El objetivo principal de Exagres son los clientes, por ese motivo estamos al corriente de las últimas tendencias para poder ofrecer productos innovadores como soluciones en escalones de gran formato y piscinas.

Exagres is characterised by the wide range of products, shaped through extrusion, that it has on offer. These products have important technical characteristics, ideal for both inside and outside the home, as well as being suitable for both public and private spaces.

Through the extrusion process, pieces are obtained with certain geometries and complex sections that are impossible to achieve through compacting, thus providing complete solutions for integral and standardised cladding with the same ceramic material.

All of this, together with the digital printing technology which permits decoration on the entire ceramic piece with any design, from low relief to the various images offered by our pieces, means that Exagres can offer a unique product with superior quality both technically and aesthetically.

The principal objective of Exagres is our customers, therefore we stay up to date with the latest trends in order to be able to offer innovative products as solutions for large scale stairs and swimming pools.

La particularité d'Exagres est d'offrir une large gamme de produits mis en forme par extrusion, aux grandes caractéristiques techniques, idéales aussi bien pour l'intérieur que pour l'extérieur du logement, en plus de pouvoir s'adresser à des espaces publics et privés.

Grâce au procédé d'extrusion, il est possible d'obtenir des pièces aux géométries spécifiques et des sections complexes impossibles à atteindre par le pressage, apportant ainsi des solutions complètes pour des revêtements intégraux et homogènes avec un même matériau céramique.

Tout cela associé à la technologie d'impression numérique, qui permet de décorer entièrement avec n'importe quel design la pièce céramique, des bas-reliefs aux différents plans qu'offrent nos pièces, permet à Exagres d'offrir un produit unique et de qualité supérieure aussi bien technique qu'esthétique.

L'objectif principal d'Exagres sont les clients, pour cette raison nous suivons les dernières tendances afin de pouvoir offrir des produits innovants tels que des solutions pour le marché des piscines et des marches de grand format.

Компания Exagres предлагает широкий спектр продукции, изготовленной путем экструзии, с высокими техническими характеристиками, идеально подходящей как для внутренней, так и наружной отделки домов, в дополнение к тому, что она может использоваться для частных и общественных пространств.

С помощью процесса экструзии мы можем изготавливать изделия с заданными размерами и сложными формами, которые невозможно достичь путем прессования, что позволяет нам предлагать универсальные решения для комплексной и однородной отделки с одним и тем же видом керамического материала.

Все это в сочетании с технологией цифровой печати, которая позволяет наносить любые изображения на керамическую плитку, начиная от рельефных текстур и заканчивая различными цветовыми решениями выпускаемых нами изделий, позволяет компании Exagres предлагать уникальную высококачественную продукцию как с технической, так и эстетической точки зрения.

Основной задачей компании Exagres является удовлетворение потребностей клиентов, поэтому мы всегда следим за последними тенденциями с тем, чтобы предлагать инновационную продукцию как крупноформатные ступени и изделия для бассейнов.

Los peldaños 150 y 120 son un avance como solución constructiva, que se adapta a las necesidades del mercado actual, evitando cortes y juntas.

Step 120 is an advance as a constructive solution, which adapts to the needs of the current market, avoiding cuts and joints

La marche 120 représente un progrès comme solution de construction, qui s'adapte aux besoins du marché actuel, en évitant les coupures et les jointures.

Ступень 120 см является шагом вперед в качестве конструктивного решения, что отвечает потребностям современного рынка и позволяет предотвратить резку плитки и образование швов.

## PELDAÑO 120 RECTO 33 x 120 x 3 cm / 33 x 60 x 3 cm

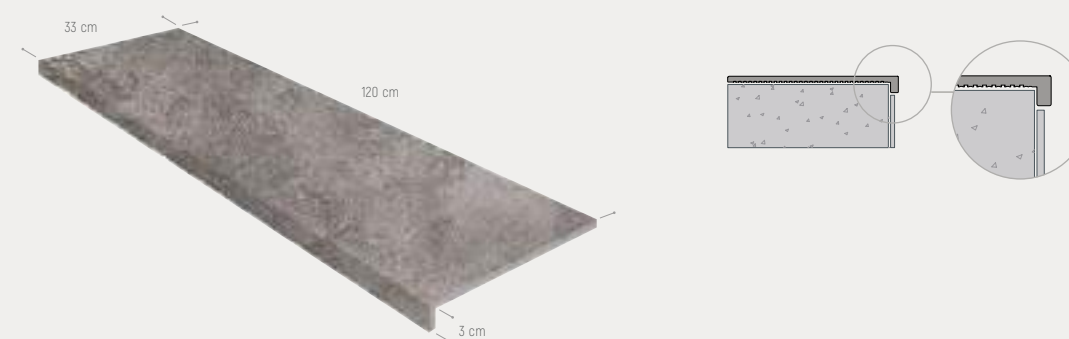

<b>IMPERIAL</b> 33 x 120 x 3 cm  Arian Ceniza Moca Siena 	<b>MARBLES</b> 33 x 120 x 3 cm - 33 x 60 x 3 cm  Calacatta Travertino Crema Marfil 	<b>MARKINA</b> 33 x 120 x 3 cm  Bianco Naro  <small>*sólo markina blanco</small>	<b>NUBIA</b> 33 x 120 x 3 cm  Nubia 
<b>ARDENAS</b> 33 x 120 x 3 cm  Marfil Cromo Gris Antracita 	<b>LITOS</b> 33 x 120 x 3 cm  Ártico Sabana Siberia 	<b>MILÁN</b> 33 x 120 x 3 cm  Arena Gris Marengo 	
<b>LIZANA</b> 33 x 120 x 3 cm  Haya Cerezo Olivo Nogal 	<b>YOHO</b> 33 x 120 x 3 cm  Maple Natural Oak Teca 	<b>ALBAROC</b> 33 x 120 x 3 cm  Boal Galena Hulla 	
<b>COSMOS</b> 33 x 120 x 3 cm  Steel Copper Corten Venus 	<b>ÓPERA</b> 33 x 120 x 3 cm  Ivory Light Silver Iron 		

PELDAÑO ML 150  
33 x 150 x 4 cm

LIZANA 33 x 150 x 4 cm

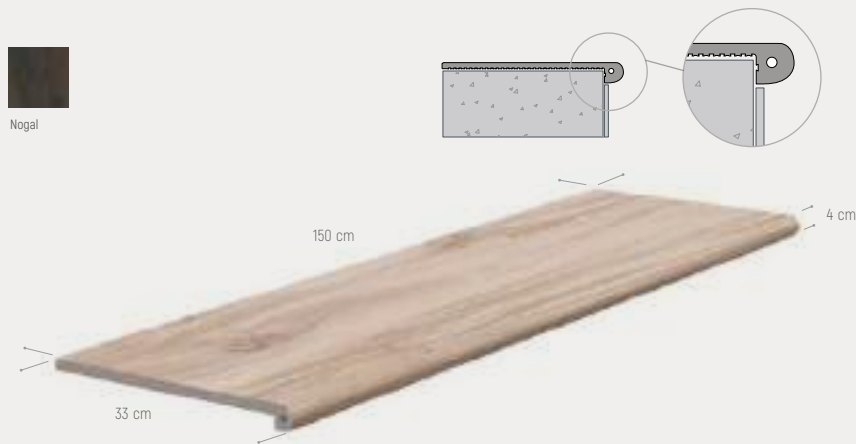
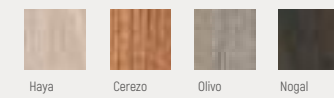

PELDAÑO ML 120  
33 x 120 x 4 cm

OROBICO 33 x 120 x 4 cm    VENATTO 33 x 120 x 4 cm

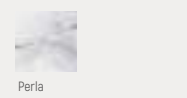
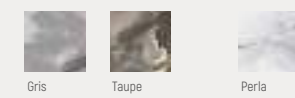

IMPERIAL 33 x 120 x 4 cm

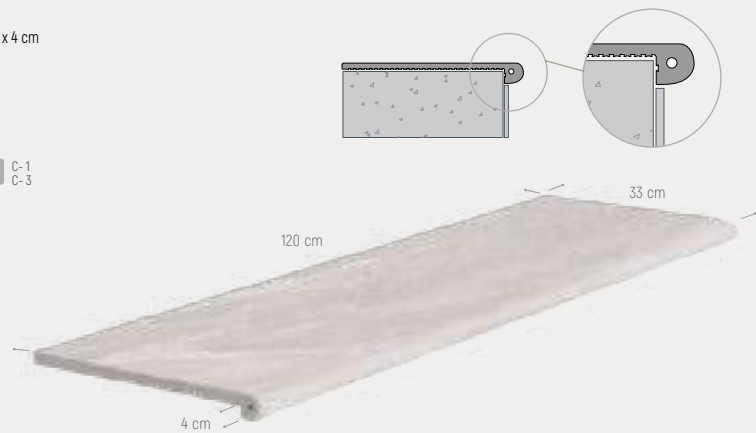

PELDAÑO 120 FIORENTINO  
33 x 120 x 3 cm

MARBLES 33 x 120 x 3 cm

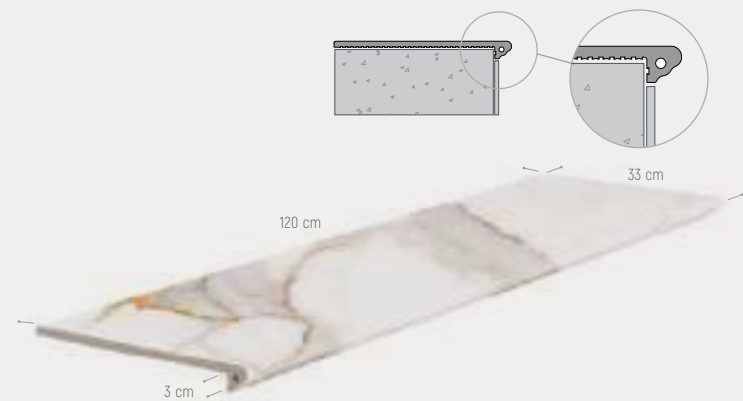
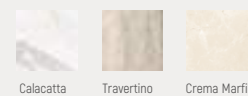

PELDAÑO RECTO  
33 x 33 x 3 cm

MILÁN 33 x 33 x 3 cm

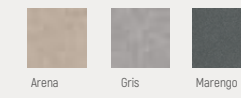

MEDITERRÁNEO 33 x 33 x 3 cm

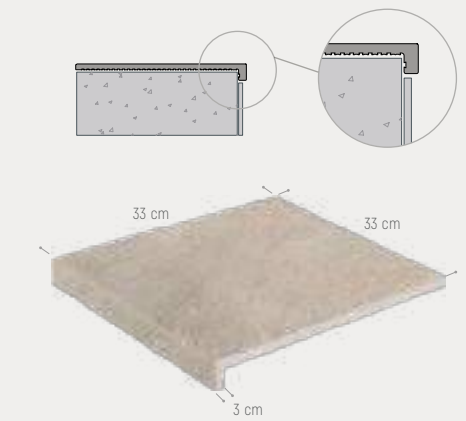
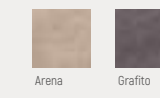

PELDAÑO ML  
24,5 x 33 x 4 cm / 33 x 33 x 4 cm

ARDENAS 33 x 33 x 4 cm

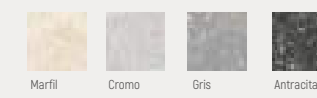

MANHATTAN 24,5 x 33 x 4 cm

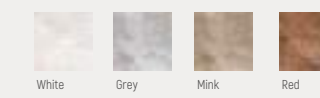

ALBAROC 33 x 33 x 4 cm

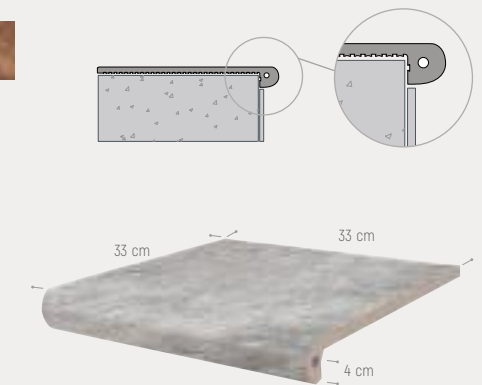
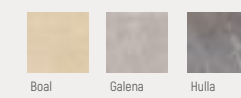

PELDAÑO FIORENTINO  
33 x 33 x 3 cm

VEGA 33 x 33 x 3 cm

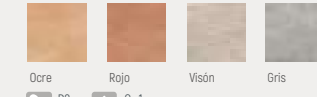

CARTABÓN FIORENTINO  
33 x 33 x 3 cm

MEDITERRÁNEO 33 x 33 x 3 cm

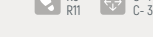
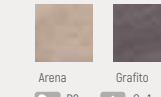

ALHAMAR 33 x 33 x 3 cm

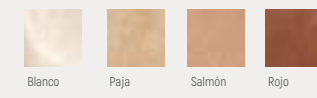

PETRA 33 x 33 x 3 cm

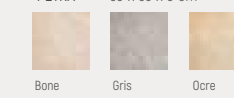

MÉTALICA 33 x 33 x 3 cm

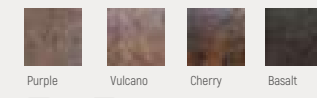

NATURA 33 x 33 x 3 cm

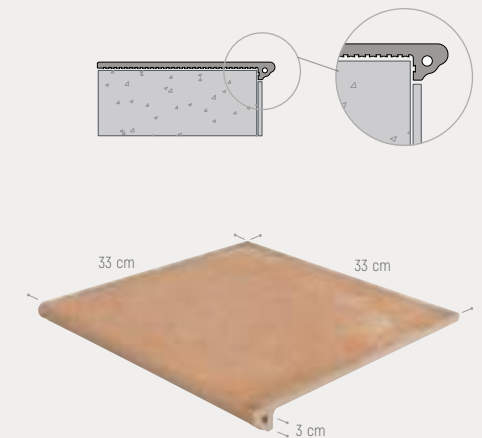
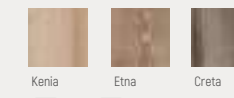

# REMATE PELDAÑO /

STEP NOSING · NEZ DE MARCHE · Нерекладина

# REMATE PELDAÑO /

STEP NOSING · NEZ DE MARCHE · Нерекладина

## REMATE PELDAÑO RECTO 3 x 33 cm



<b>IMPERIAL</b> 3 x 33 cm	<b>MARBLES</b> 3 x 33 cm	<b>MARKINA</b> 3 x 33 cm
Arian	Calacatta	Blanco
Ceniza	Travertino	Nero
Moca	Crema Marfil	
Siena		
<b>ARDENAS</b> 3 x 33 cm	<b>LITOS</b> 3 x 33 cm	<b>ALBAROC</b> 3 x 33 cm
Marfil	Ártico	Boal
Cromo	Sabana	Galena
Gris	Siberia	Hulla
Antacita		
<b>LIZANA</b> 3 x 33 cm	<b>YOHO</b> 3 x 33 cm	<b>MILÁN</b> 3 x 33 cm
Haya	Maple	Arena
Cerezo	Natural	Gris
Olivo	Oak	Marengo
Nogal	Teca	
<b>COSMOS</b> 3 x 33 cm	<b>ÓPERA</b> 3 x 33 cm	
Steel	Ivory	
Copper	Light	
Corten	Silver	
Venus	Iron	

## REMATE ML 4 x 33 cm



<b>IMPERIAL</b> 4 x 33 cm	<b>LIZANA</b> 4 x 33 cm	<b>OROBICO</b> 4 x 33 cm	<b>VENATTO</b> 4 x 33 cm
Arian	Haya	Gris	Perla
Ceniza	Cerezo	Taupe	
Moca	Olivo		
Siena	Nogal		

## REMATE PELDAÑO FIORENTINO DCHA./IZDA. 3 x 33 cm



<b>MARBLES</b> 3 x 33 cm
Calacatta
Travertino
Crema Marfil

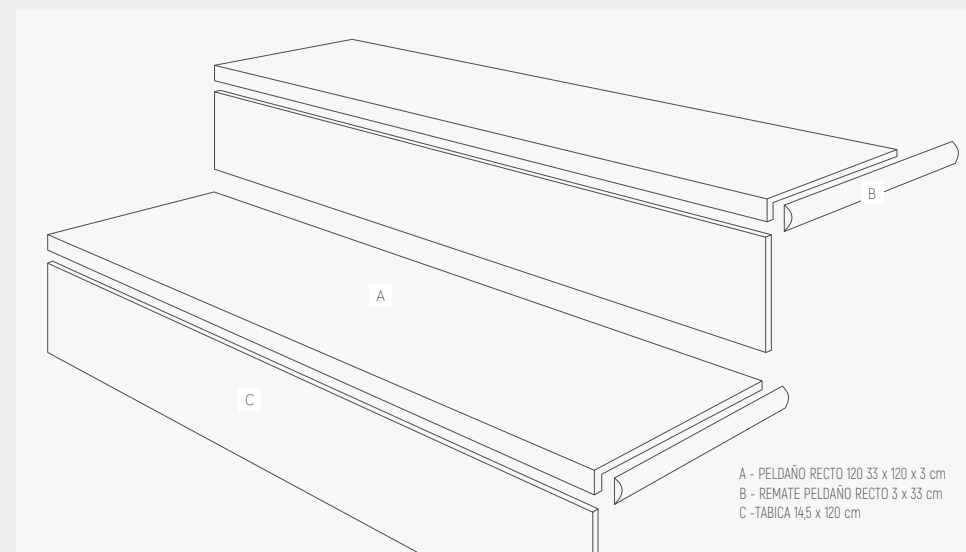

A - PELDAÑO RECTO 120 33 x 120 x 3 cm  
B - REMATE PELDAÑO RECTO 3 x 33 cm  
C - TABICA 14,5 x 120 cm



# ZANQUINES /

SKIRTING BOARD · PLINTHE · Лестничный плинтус

# ZANQUINES /

SKIRTING BOARD · PLINTHE · Лестничный плинтус

## ZANQUÍN INGLETADO RECTO 59,6 x 59,6 cm

### IMPERIAL

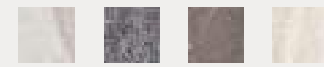

### LIZANA



### ARDENAS

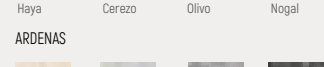

### COSMOS

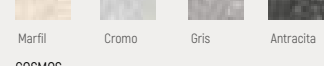

### YOHO



### Steel



### Natural



## ZANQUÍN INGLETADO ML IZDA./DCHA. 59,6 x 59,6 cm

### IMPERIAL

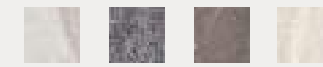

### LIZANA



### ARDENAS

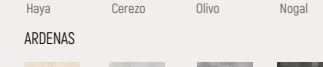

### COSMOS

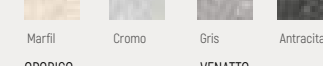

### YOHO

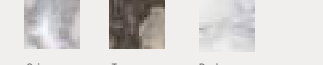

### Steel

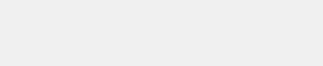

### Natural

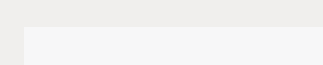

## ZANQUÍN FIORENTINO IZDA./DCHA. 32,8 x 32,8 cm

### VEGA

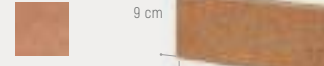

### Rojo

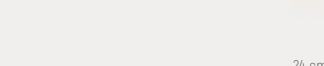

### Bone

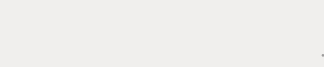

### Ocre



### Alhama



### Paja

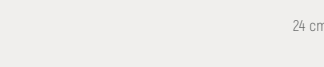

### Alhama

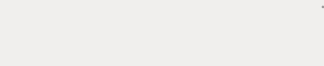

### Paja

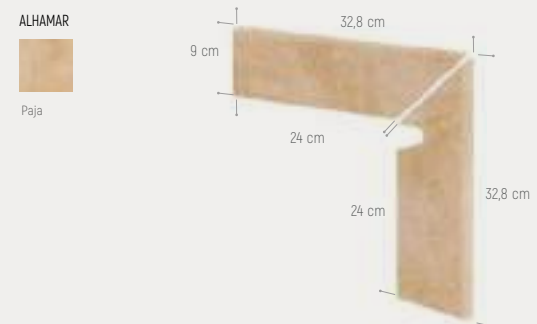
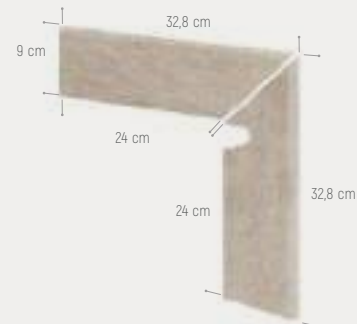
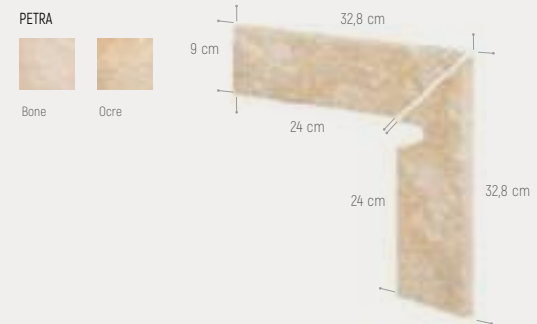
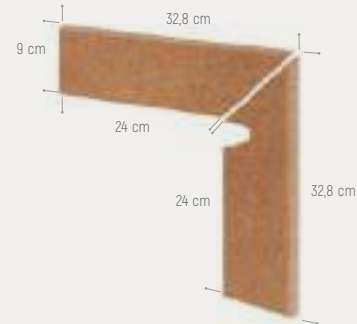

A - ZANQUÍN INGLETADO ML 59,6 x 59,6 cm  
B - PELDAÑO ML 150 33 x 150 x 4 cm  
C - 14,5 x 150 cm

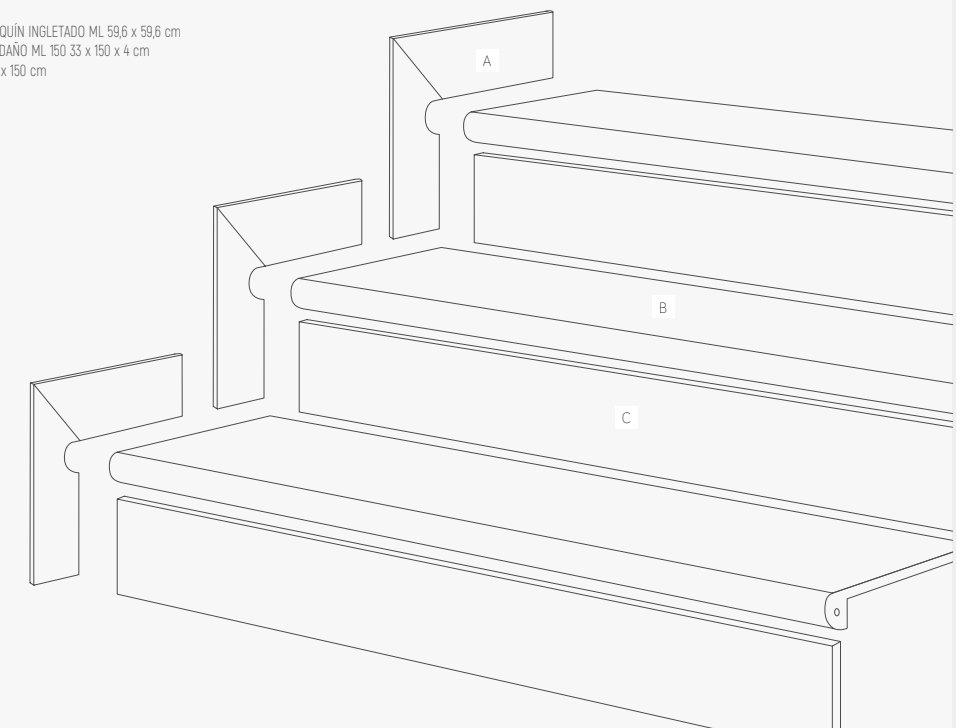











# ZANQUINES /

SKIRTING BOARD · PLINTHE · Лестничный плинтус

# ZANQUINES 18x40 /

SKIRTING BOARD · PLINTHE · Лестничный плинтус

## ZANQUÍN RECTO IZDA./DCHA. 42,3 x 17,5 cm

<b>YOHO</b> 42,3 x 17,5 cm	<b>MEDITERRÁNEO</b> 42,3 x 17,5 cm
 Maple  Teca	 Arena  Grafito
<b>MILÁN</b> 42,3 x 17,5 cm	<b>ÓPERA</b> 42,3 x 17,5 cm
 Arena  Gris  Marengo	 Ivory  Light  Silver  Iron



## ZANQUÍN ML IZDA./DCHA. 39,5 x 17,5 cm

<b>MANHATTAN</b> 39,5 x 17,5 cm
 White  Grey  Mink  Red













## ZANQUÍN FIORENTINO IZDA./DCHA. 39,5 x 17,5 cm

<b>NATURA</b> 39,5 x 17,5 cm	<b>VEGA</b> 39,5 x 17,5 cm
 Kenia  Etna  Creta	 Ocre  Visón  Gris
<b>METÁLICA</b> 39,5 x 17,5 cm	<b>PETRA</b> 39,5 x 17,5 cm
 Purple  Vulcano  Cherry  Basalt	 Gris
<b>ALHAMAR</b> 39,5 x 17,5 cm	<b>MEDITERRÁNEO</b> 39,5 x 17,5 cm
 Blanco  Salmon  Rojo	 Grafito



## ZANQUÍN RECTO 18 x 40 cm

<b>MARBLES</b> 18 x 40 cm	<b>MARKINA</b> 18 x 40 cm
 Calacatta  Travertino  Crema Marfil	 Bianco  Nero
<b>LITOS</b> 18 x 40 cm	<b>ALBAROC</b> 18 x 40 cm
 Ártico  Sabana  Siberia	 Boal  Galena  Hulla





## ZANQUÍN ML IZDA./DCHA. 18 x 40 cm

<b>ALBAROC</b> 18 x 40 cm
 Boal  Galena  Hulla



## ZANQUÍN FIORENTINO IZDA./DCHA. 18 x 40 cm

<b>MARBLES</b> 18 x 40 cm
 Calacatta  Travertino  Crema Marfil

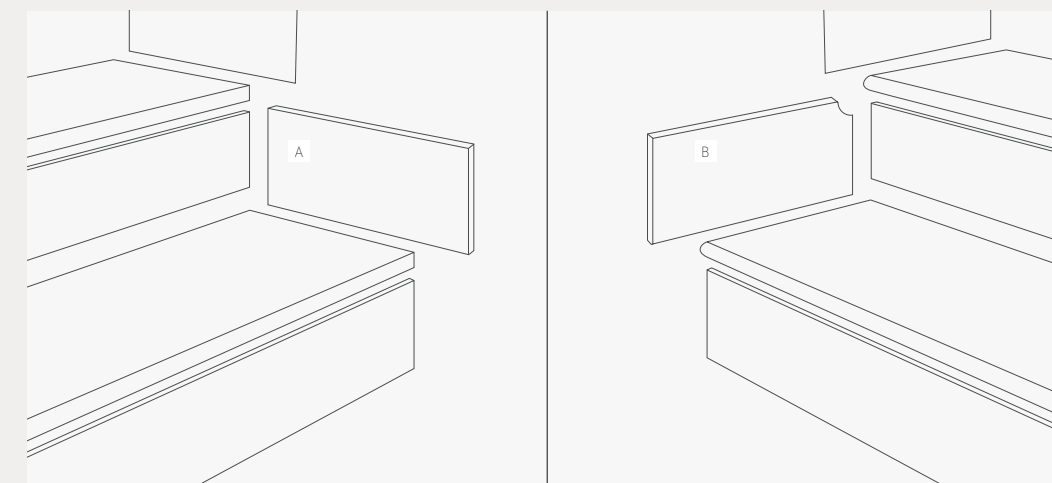

A - ZANQUÍN RECTO DCHA. 18 x 40 cm  
B - ZANQUÍN ML IZDA. 18 x 40 cm

## CORONACIÓN SKIMMER. SKIMMER SYSTEM

### BORDE SKIMMER. 45x75x3 cm

#### VENATTO

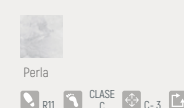

#### MILÁN

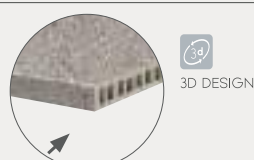
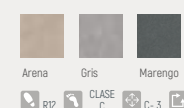

D. Continuidad gráfica, parte trasera.  
Graphic continuous, backside.

#### IMPERIAL



#### ARDENAS

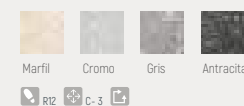

#### ÓPERA

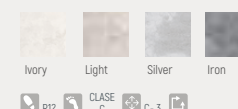

#### YOHO

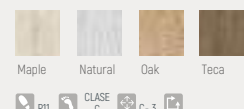

### BORDE PISCINA. 28 x 66,5 cm

#### NATURA

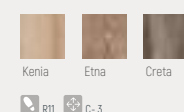

### BORDE PISCINA. 28 x 33 cm

#### PETRA

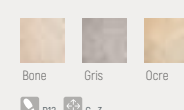

### ÁNGULO INTERIOR. 33x33 cm

#### NATURA

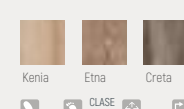

#### PETRA

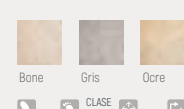

### ÁNGULO EXTERIOR. 28x28 cm



## CORONACIÓN SKIMMER. SKIMMER SYSTEM

### BORDE PISCINA. PELDAÑO ML 150. 33 x 150 x 4 cm

#### LIZANA

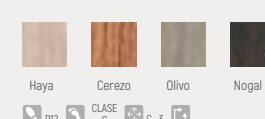

### BORDE PISCINA. PELDAÑO 120 RECTO. 33 x 120 x 3 cm

#### NUBIA

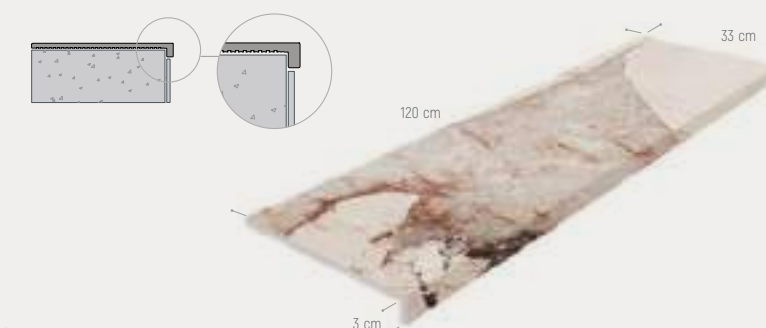
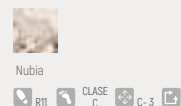

### BORDE PISCINA. PELDAÑO 60 RECTO. 33 x 60 x 3 cm

#### MARBLES

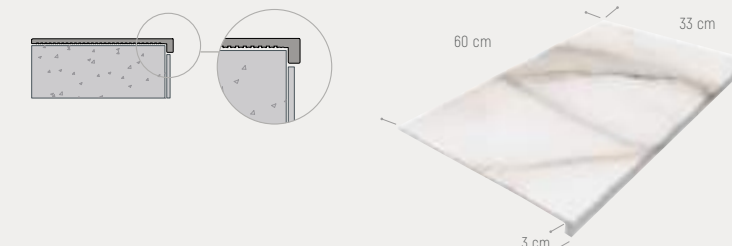
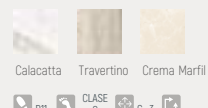

### PIEZAS VASO PISCINA CORONACIÓN SKIMMER . SKIMMER SYSTEM POOL BASIN PIECES

#### IMPERIAL

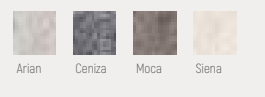

#### VENATTO

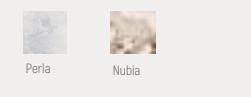

#### NUBIA

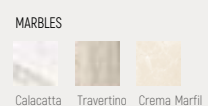
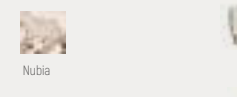

#### ÓPERA

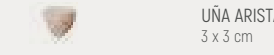
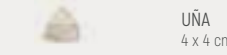
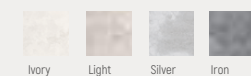

## CORONACIÓN DESBORDANTE. OVERFLOW SYSTEM

BORDE DESBORDANTE. 28x66,5 cm    ÁNGULO BORDE DESBORDANTE. 31x31 cm

### VENATTO



Perla



### LITOS



Artico

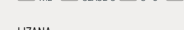

### LIZANA



Haya



### IMPERIAL



Arian

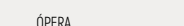

### ÓPERA



Ivory

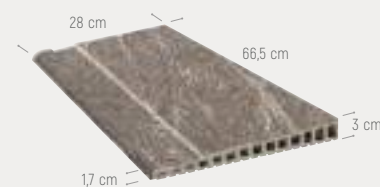
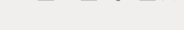

REJILLA. 24,5 x 24,5 cm

### VENATTO



Perla



### LITOS



Artico

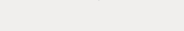

### LIZANA



Haya



REJILLA. 24,5 x 66,5 cm\*

### LIZANA



Haya

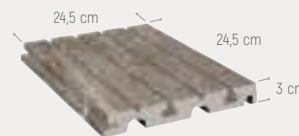
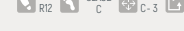
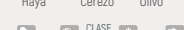

\*sólo serie Lizana

ÁNGULOS REJILLA IZDA. DCHA.

### VENATTO



Perla



### LITOS



Artico

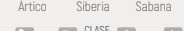

### IMPERIAL



Arian

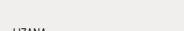

### LIZANA



Haya

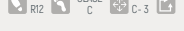
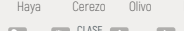

### ÓPERA



Ivory

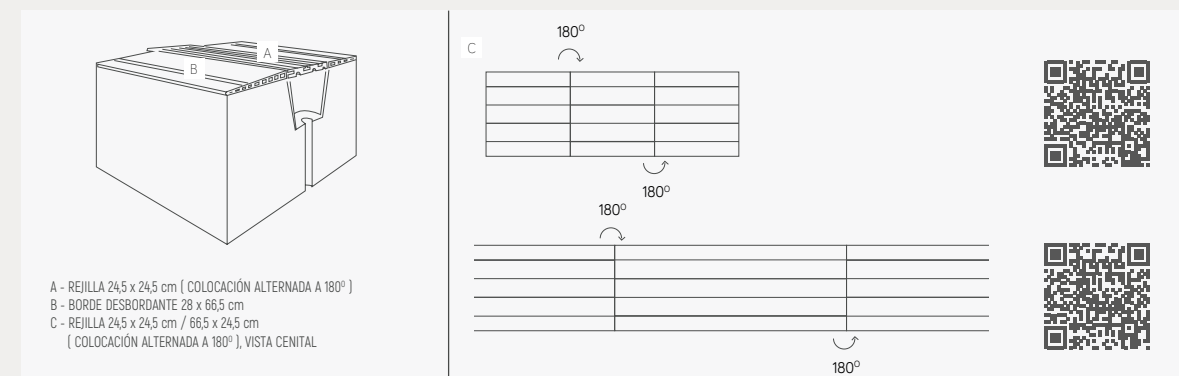
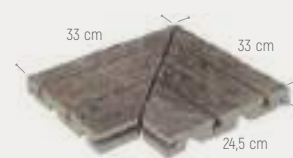
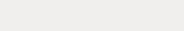

Las rejillas cerámicas de Exagres deben colocarse sueltas, apoyadas y sin rejuntar, nunca pegadas.

Exagres ceramic gratings should be laid loose, supported and not grouted, never glued.

Les caillébotis céramiques Exagres doivent être posés en vrac, soutenus et non jointoyés, jamais collés.

Керамические решетки Exagres следует укладывать свободно, с опорой, не затирать и никогда не приклеивать.

No rejuntar  
No pegar

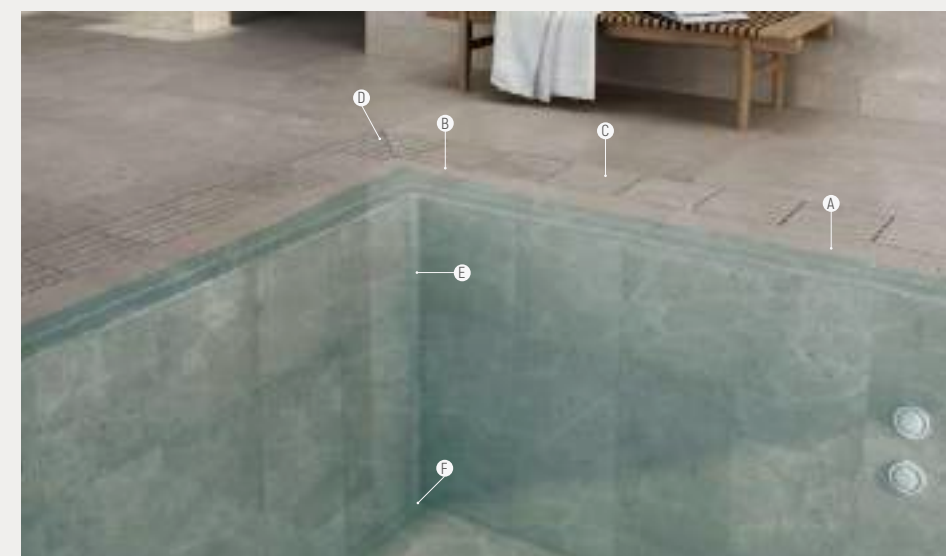

### OUTDOOR

- A - Borde desbordante
- B - Ángulo borde desbordante
- C - Rejilla
- D - Ángulo rejilla izda/dcha

### PISCINA INDOOR

- E - Media caña
- F - Uña

## PIEZAS VASO PISCINA CORONACIÓN DESBORDANTE. OVERFLOW SYSTEM POOL BASIN PIECES

### IMPERIAL



Arian

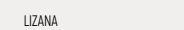

### LIZANA



Haya



### ÓPERA



Ivory

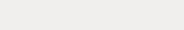

### VENATTO



Perla

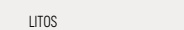

### LITOS



Artico

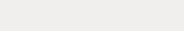
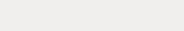

MEDIA CAÑA  
33 x 4 cm - r-3 cm



UÑA  
4 x 4 cm



ÁNGULO EXTERIOR ARISTA\*  
5 x 5 cm



ARISTA  
33 x 3 cm - r-3 cm



UÑA ARISTA  
3 x 3 cm



ÁNGULO INTERIOR ARISTA\*  
5 x 5 cm

\*sólo series Imperial y Venatto

# VIERTEAGUAS /

WINDOW SILLS · APPUIE DE FENÊTRE · Подоконник

VIERTEAGUAS. 15 x 24,5 x 4 cm / 12 x 33 x 3 cm / 15 x 33 x 4 cm

## DESCRIPCIÓN · DESCRIPTION · DESCRIPTION · ОПИСАНИЕ

- Forma rectangular con borde lateral redondeado provisto de goterón. Superficie inferior ranurada en cola de milano para optimizar el agarre al soporte.
- Rectangle shape with lateral rounded edge provided with big drop. Back tile in dove tail profile to improve the hold to the stab.
- Format rectangulaire, le bord latérale arrondi avec dispositif anti-goute. La surface inférieure fendue en queue d'aronde pour optimiser l'adhérence de l'appui.
- Элементы имеют прямоугольную форму с одним закругленным краем для облегчения дренажа. Обратная сторона элементов выполнена в форме сечения "ласточкин хвост" для надежной фиксации элемента.

## APLICACIONES Y COLOCACIÓN · APPLICATIONS AND INSTALLATION · APPLICATIONS ET POSE · ПРИМЕНЕНИЕ И МОНТАЖ

- Vierendeaguas en ventanas, marquesinas, voladizos, repisas, remate superior de muros medianeros, perimetrales y cercas.
- Window Sills in windows, porches, projecting, brackets, top finishing for diving walls, perimeter walls and fences.
- Appuie pour les fenêtres, marquises, rebords, finition supérieur de murs mitoyens, des clôtures, etc.
- Данная плита укладывается как подоконник, так же подходит для отделки террас, изгородей, а так же как наружная облицовка.

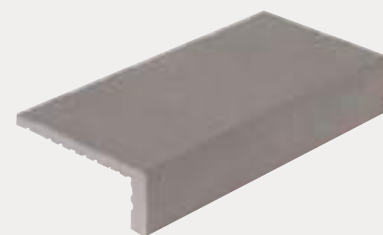

# PASAMANOS /

HANDDRAILS MAIN COURANT · COUVRE MURS · ПОРУЧНИ

PASAMANOS. 12,5\* x 66,5 x 4 cm / 15,5\* x 66,5 x 4 cm

\*medidas interiores. inner measures.

## DESCRIPCIÓN · DESCRIPTION · DESCRIPTION · ОПИСАНИЕ

- Forma rectangular con bordes laterales redondeados provistos de goterón, la parte superior dispone de una ligera curvatura que facilita el drenaje. Superficie interior ranurada en cola de milano para optimizar el agarre al soporte.
- Rectangle shape with lateral rounded edges provided with big drop, the top side has a slight curvature (bend) to ease the drainage. Back tile in dove tail profile to improve the hold to the stab.
- Format rectangulaire, les bords latérales arrondis avec dispositif anti-goute, la partie supérieure dispose d'une très légère courbature pour faciliter le drainage. Superficie intérieur rainurer pour faciliter la pose sur tous types de support.
- Элементы имеют прямоугольную форму с закругленными краями по углам, верхняя сторона имеет небольшой изгиб для облегчения дренажа. Обратная сторона элементов выполнена в форме сечения "ласточкин хвост" для надежной фиксации элемента.

## APLICACIONES Y COLOCACIÓN · APPLICATIONS AND INSTALLATION · APPLICATIONS ET POSE · ПРИМЕНЕНИЕ И МОНТАЖ

- Cubremuros, antepechos de terrazas, azoteas, tendederos, escaleras, pretilos y coronación de cercas y muros divisorios.
- Top-wall finishing, terrace parapets, flat roofs, drying places, stairs, handrails and tops for fences and dividing walls.
- Main courante, couvre-murs, finition de murs verticales, etc.
- Используется в качестве поручней и перил лестниц. Может применяться для финишной отделки парапетов террас, плоских крыш, верхнего облицовочного элемента стенок, перегородок и т.д.

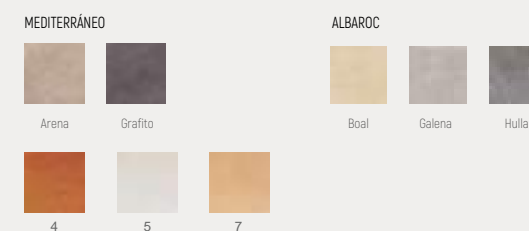

## RECOMENDACIONES DE COLOCACIÓN

Las Series de EXAGRES, S.A. están fabricadas en gres extruido de baja absorción de agua, bajo la norma de producto UNE-EN 14411 Grupo Alb. Aunque el dorso de las piezas está estriado en cola de milano para aumentar la adhesión de las mismas al mortero de agarre, EXAGRES recomienda, sin excluir otros posibles métodos, la colocación de baldosas y piezas especiales con mortero adhesivo predosificado (tipo cemento-cola) de buena calidad adecuado al uso y condiciones de uso del recubrimiento cerámico. En zona de climatología severa, riesgo de heladas o colocación en exteriores o piscinas, se recomienda utilizar morteros adhesivos "tipo flexible", "especial porcelánico", "especial fachadas" o "especial piscinas" en cada caso, de un fabricante reconocido de materiales de instalación de cerámica, disponible en almacenes de materiales.

## SOPORTE DE COLOCACIÓN

Deberá ser estable dimensionalmente, sano, sólido, resistente y rígido, con superficie de rugosidad suficiente. Soportes flexibles o estructuras deformables requieren una capa de desolidarización y juntas de movimiento, formatos menores y juntas de colocación más anchas.

## COLOCACIÓN EN CAPA GRUESA

En caso de utilizar el sistema tradicional, recomendamos usar morteros de capa gruesa mejorados con aditivo látex para aumentar la adhesión de la capa de agarre con la cerámica de baja absorción. Existen morteros adhesivos preparados de capa media que permiten nivelar (hasta 2-3 cm.) e instalar la cerámica a la vez.

## COLOCACIÓN EN CAPA FINA

Previamente hay que regularizar el soporte con una capa de mortero de nivelación. Sobre el soporte nivelado se extiende el mortero adhesivo en capa fina (TIPO C2 según norma UNE EN 12004:01), en lecho continuo, con llana dentada de tamaño adecuado. En solados exteriores se resolverán cuidadosamente las pendientes de desagüe, la impermeabilización del soporte y la confección de juntas perimetrales y juntas de partición cada 5x5 m. como máximo. La junta de las piezas será la recomendada según norma UNE EN 13888 (≤5 mm), para respetar la modularidad de las series y la correspondencia de juntas entre los diferentes formatos y/o piezas especiales.

IMPORTANTE: se respetará la dirección del ranurado posterior de las baldosas, colocándolas siempre en la misma dirección.

## REJUNTADO

El rejuntado se efectuará con un material de prestaciones adecuadas a la solicitud del recubrimiento durante su uso, y se optará por un mortero preparado de cualquier fabricante reconocido, ya que ofrecen una amplia gama de colores y materiales de diferentes características. El tipo de mortero de juntas adecuado será Tipo CG2 (según UNE EN 13888) usando , en caso de requerir resistencia química materiales Tipo RG.

## ASESORAMIENTO

Es conveniente contar con el asesoramiento del fabricante de materiales de instalación elegido, para que facilite información sobre prestaciones, instrucciones de uso, tiempo abierto, etc. así como procedimientos de limpieza de la instalación después de la colocación y el rejuntado.

## TAREAS PREVIAS A LA COLOCACIÓN

Las baldosas se mezclarán antes de su colocación para conseguir una destonificación armónica, abriendo varias cajas de diferentes pallets, en su caso.

## LIMPIEZA DE OBRA Y MANTENIMIENTO

Si después de la colocación y la primera limpieza, quedan restos de materiales cementosos sobre la superficie de la instalación, usar un limpiador cerámico o desincrustante ácido adquirido en cualquier almacén de materiales. Antes de la aplicación mojar el recubrimiento para saturar las juntas de agua y protegerlas de la acción del limpiador. Después del lavado, eliminar el producto con abundante agua limpia. Para el mantenimiento ordinario, existen productos adecuados específicos para cerámica.

## PAVIMENTOS EXTERIORES

Los pavimentos exteriores se encuentran sometidos continuamente a duras condiciones atmosféricas y a la acción de heladas y choque térmicos, que pueden provocar daños irreparables en la instalación. Por ello se extremará el control de ejecución y la calidad de los materiales empleados.

Se asegurará la estanqueidad de la instalación para evitar filtraciones de agua al soporte y se resolverá cuidadosamente el sellado de las juntas, entre piezas, perimetrales y de dilatación. Las juntas de dilatación y partición atravesarán el solado, la capa de agarre y la de nivelación.

## RECLAMACIONES

La legislación actual requiere que las demandas sean presentadas antes de la colocación de las baldosas. De modo que no se considerarán reclamaciones sobre materiales ya colocados.

## INSTALLATION SUGGESTIONS

EXAGRES, S.A. Series is a glazed and very low water absorption extruded ceramic, product norm EN 14411 Alb Group. Although the back tiles profiled in dove tail to increase the adherence to the setting mortar, EXAGRES recommend, without excluding any other possible systems, installing the tiles and special pieces with a thin set mortar method.

In outdoor places with a hard cold weather, risk of freeze or when placing in exterior wall, the use of "flexible thin set mortar" is recommended, "special porcelanic tile" or "high strength mortar" from a known manufacturer of ceramic tile installation materials, available in any building materials warehouse or tiles dealer.

## INSTALLATION SLAB

Must be clean, dry, structurally sound and ensure the rough surface.

A cleavage membrane is necessary in concrete slabs with a deflection and building structures with a movement. Small sizes tiles, wide joints between tiles and movement joints are recommended.

## THICK BED METHOD

In that case, use cement mortars with latex admix, for improved bond to the very low absorption tiles.

You can use medium thickness bed mortars for leveling and installing.

## THIN BED METHOD

The installation system, over clean, dry structurally sound and free from any bond breaking surface, consist in placing a thin bond coat (C2 Type EN 12004:01 norm), extended continuously with notched trowel. In exteriors the water draining slopes will be carefully resolved, as well the waterproofing slab and the placing perimeter joints and expansion joints every 5x5 m.

The recommended joint between pieces will be 5 mm, to respect modularity and the correspondance of joints between different sizes and/or specials pieces.

VERY IMPORTANT we recommend setting the pieces with the back grooved in the same direction.

## GROUTING

The grouting will be done by a grout that adequates its characteristics to the coating and the use of installation, choosing any grout from any known manufacturer, whose range of colours and materials are usually wider. Grout must be CG2 Type (EN 13888 norm) using grout RG Type (epoxy grout) for best chemical and stain resistance.

## TECHNICAL SUPPORT

It is recommended to be advice by the chosen manufacturer in order to be technical supported about characteristics, instructions of use, open time, etc. as well as cleaning tips after installing tiles.

## PREVIOUS TASKS BEFORE INSTALLATION

Before laying the tiles, mix them from several boxes and pallets, in order to ensure a uniform look and the best result.

## CLEANING AND MAINTENANCE

After the installation and the first cleaning, remove the cured grout with a commercial ceramic cleaner, or acid remover from any ceramic tile installation products manufacturer. Follow the instructions of use from manufacturer. Use specific ceramic cleaners in the maintenance tasks.

## EXTERIORS FLOORS

Exterior floors are submitted to several requirements and weather conditions, frost, thermal shocks, etc. which are able to cause damages.

It is essential to check the masonry works, installation method and quality of tiling materials.

Appropriate slopes, waterproofing, expansion and perimeter joints, grouting and sealing the joints, are fundamental.

## COMPLAINTS

Note that current legislation requires disputes to be before installation tiles. Complaints concerning already laid materials shall not, therefore, be proposed and shall not be considered.

## RECOMMANDATIONS POUR LA POSE

Les séries d'EXAGRES S.A. ont été fabriquées en gres étiré. Ce carreaux ont une absorption d'eau basse selon la norme EN 14411 Groupe Alb. Bien que la queue d'aronde du dos des carreaux serve à mieux les adhérer au mortier, Exagres conseille de placer les carreaux et pièces spéciales à l'aide d'un mortier adhésif prédosé (genre ciment-colle) de bonne qualité et approprié aux possibles domaines d'application des carreaux.

## SUPPORT

Le support doit être solide, résistant, rigide et suffisamment rugueux. Les supports souples ou les structures déformables ont besoin d'une couche de désolidaritation; des joints de mouvement, des formats plus petits, ainsi que des joints plus larges.

## POSE EN COUCHE ÉPAISSE

En ce qui concerne le système traditionnel, nous recommandons l'utilisation de mortiers à couche épaisse améliorés à base d'additif latex afin d'augmenter l'adhésion de la couche d'adhérence avec la céramique à absorption basse. Il existe des mortiers adhésifs à couche moyenne déjà préparés qui permettent de niveler (jusqu'à 2-3 cm) et installer les carreaux au même temps.

## POSE EN COUCHE MINCE

Premièrement il faut régulariser le support à l'aide d'une couche de mortier de nivellement. Sur le support nivelé il faut étendre le mortier adhésif en couche mince [TYPE C2 selon UNE EN 12004 :01] et continueuse avec une truelle dentée. Quant aux surfaces extérieures il faut faire attention aux pentes de drainage, à l'imperméabilisation du support. Nous recommandons faire des joints de dilatation tous les 5x5 m au maximum. Les joints entre les carreaux doivent avoir une largeur de 5 mm afin de respecter la modularité des différentes séries.

ATTENTION: il est conseillé de poser les carreaux de façon à ce que la queue d'aronde suive toujours la même direction.

## JOINTOLEMENT

Il est conseillé d'effectuer le jointolement avec du matériel approprié au domaine possible d'application des carreaux, en choisissant un mortier d'un fabricant spécialisé, puisqu'ils offrent un grand choix de couleurs et matériaux. Le mortier pour joints le plus approprié est celui de Type CG2 (selon UNE EN 13888). Nous recommandons le matériel du Type RG pour obtenir une résistance aux produits chimiques complémentaire.

SUGGESTION: Il est recommandable de se faire conseiller par le fabricant du matériel choisi par rapport aux caractéristiques, mode d'emploi, temps d'ouverture. Également il peut vous conseiller sur le nettoyage du sol après la pose des carreaux.

## RECOMMANDATIONS AVANT LA POSE

Pour que la surface totale de carrelage ait une détonification harmonique, nous conseillons de mélanger des carreaux de différentes boîtes.

## NETTOYAGE ET ENTRETIEN

Dans le cas où il resterait des traits de mortier sur la surface d'installation, il faudrait utiliser un produit spécifique pour la céramique ou, autrement, un produit désincrustant. Premièrement il est conseillé de mouiller la surface à nettoyer avec l'objectif de remplir les joints d'eau et les protéger de l'action du produit nettoyant. Une fois le nettoyant appliqué, il faut rincer avec de l'eau propre. Pour ce qui concerne l'entretien ordinaire, il existe des produits spécifiques pour la céramique.

## REVÊTEMENTS À L'EXTÉRIEUR

Les carreaux posés à l'extérieur peuvent souffrir les effets des chocs thermiques, des gelées, etc, ce qui peut endommager l'installation. De ce fait il faut absolument faire attention aux travaux de pose du carrelage, ainsi qu'à la qualité des matériaux y utilisés. Il faut éviter les filtrations d'eau dans le support. Il faut également faire attention à bien sceller tous les joints.

## RÉCLAMATIONS

Selon la loi actuelle aucune réclamation ne sera prise en compte après la pose des carreaux céramiques. Une fois les carreaux placés, les réclamations ne seront pas prises en compte.

# РЕКОМЕНДАЦИИ ПО УКЛАДКЕ КЕРАМИЧЕСКОЙ ПЛИТКИ И СПЕЦИАЛЬНЫХ ЭЛЕМЕНТОВ /

## РЕКОМЕНДАЦИИ ПО УКЛАДКЕ КЕРАМИЧЕСКОЙ ПЛИТКИ И СПЕЦИАЛЬНЫХ ЭЛЕМЕНТОВ EXAGRES

Все коллекции фабрики EXAGRES, S.A. произведены по технологии экструдированного клинкера. Керамическая плитка и элементы EXAGRES имеют низкое водопоглощение в соответствии с нормативом EN 14411 Группа Alb.

## ОБЩИЕ РЕКОМЕНДАЦИИ

Технология подготовки оснований и укладки керамической плитки, а также специальных элементов должна соответствовать строительным правилам и нормам вашего региона.

При использовании материалов необходимо тщательно следовать рекомендациям и правилам применения Производителей данных материалов

## НАПОЛЬНАЯ ПЛИТКА ДЛЯ НАРУЖНОГО ПРИМЕНЕНИЯ

Внешние покрытия всегда подвергаются воздействию погодных условий, мороза, перепадов температуры, что может послужить причиной деформации укладки. Поэтому, рекомендуем Вам контролировать процесс укладки и качество используемых материалов и растворов.

Основание должно быть должным образом усилено арматурой и гидроизолировано, чтобы избежать протечек воды.

Рекомендуется хорошо заполнять швы между плитками, компенсационные швы и швы по периметру, примыкающие к стенам здания. Компенсационные швы должны полностью пересекать все основание.

## ОСНОВАНИЕ, НА КОТОРУЮ БУДЕТ УКЛАДЫВАТЬСЯ ПЛИТКА

Основание, на которую будет укладываться плитка должна быть идеально ровное, прочное, устойчивое и твердое. Поверхность основания должна быть достаточно шероховатой.

При необходимости, при наружных работах, основание должно быть гидроизолировано.

Плитка и ступени на наружных площадках и лестницах должны быть уложены под определенным углом, для избегания застоя воды

## КЛЕЕВЫЕ СМЕСИ

EXAGRES рекомендует, укладывать облицовочную плитку с использованием качественных клеевых цементных смесей, отвечающим требованиям эксплуатации плитки.

Для укладки плитки в бассейнах, в местах с контрастным климатом, а также при наружных работах, рекомендуется использовать профессиональные клеевые смеси, пригодные для реальных условий эксплуатации, например:

- специальный для наружных работ
- специальный для керамогранита
- специальный для фасадов
- специальный для бассейнов
- специальный для клинкера

Клеевые смеси, которые будут использоваться для укладки плитки EXAGRES, должны быть пригодны для приклейки плитки с низким коэффициентом водопоглощения, согласно рекомендациям производителя клеевой смеси

## УКЛАДКА В ТОЛСТОМ СЛОЕ

При укладке плитки с одновременным выравниванием основания, а также при толщине плиточного клея до 2-3 см, рекомендуется специальный клей для толстого слоя с латексными добавками.

## УКЛАДКА В ТОНКОМ СЛОЕ

Прежде чем наносить слой клея, требуется выровнять основание.

Клеевая смесь наносится зубчатым шпателем на ровное основание тонким слоем

## УКЛАДКА ПЛИТКИ

EXAGRES рекомендует перед укладкой плитки и ступеней, вынуть ее из всех коробок и тщательно перемешать между собой, для того чтобы достичь гармоничной разнотонности.

Укладка плитки осуществляется по направлению полос, которые находятся на задней стороне плитки и элементов

## КОМПЕНСАЦИОННЫЙ ШОВ РАСШИРЕНИЯ

При укладке плитки на подвижные основания, которые могут деформироваться в процессе эксплуатации требуется предусмотреть компенсационный шов расширения между рядами плитки. Компенсационный шов расширения рекомендуется делать каждые 5x5 м, а также в местах примыкания площадок к стенам зданий. Ширина шва должна быть не меньше 5 мм. Шов расширения должен быть заполнен эластичным наполнителем.

## ЗАТИРКА

Затирочный раствор для швов, выбирается в зависимости от условий дальнейшей эксплуатации настиленной поверхности. При укладке снаружи затирка может быть сделана влагостойкой с помощью специальных добавок.

## ОКОНЧАТЕЛЬНАЯ ЧИСТКА И УХОД

После укладки плитки для удаления цементного налета рекомендуется использовать специальное средство для снятия налета, которые имеются у поставщиков клеевой смеси.

Перед использованием средства для удаления налета необходимо намочить швы водой, для того, чтобы их защитить.

После очистки требуется окончательно смыть средство водой из шланга или аппарата высокого давления

Для регулярной чистки рекомендуется использование подходящего для керамики средства.

La **extrusión** es una técnica de conformado para la fabricación de productos cerámicos. Básicamente el proceso de extrusión consiste en forzar el paso, mediante la aplicación de presión, de la pasta con consistencia plástica a través de una matriz. La fabricación de baldosas mediante el proceso de extrusión consta de cuatro fases principales: amasado, conformado, secado y cocción.

- el amasado consiste en el mezclado con agua de las materias primas previamente preparadas y molidas. Con esto se consigue una pasta fácilmente moldeable por extrusión.

- en el conformado se realiza introduciendo la masa plástica en la extrusora, y con presión de vacío es amasada y empujada a través de la boquilla para obtener las piezas finales. Con este proceso se pueden obtener piezas especiales como peldaños o bordes piscinas, etc...

- después las piezas ya moldeadas son sometidas a aire caliente para eliminar el contenido de humedad.

- posteriormente son cocidas a altas temperaturas, obteniendo una perfecta vitrificación de las mismas.

Con este proceso los materiales pueden ser reciclados en su totalidad y admiten hasta un 45% de materiales reciclados en su proceso estándar.

**Extrusion** is a shaping technique for the manufacture of ceramic products. Basically, the extrusion process consists of forcing the passage, through the use of pressure, of a paste with plastic consistency through a grid. The manufacture of tiles through the extrusion process consists of four main phases: kneading, shaping, drying and firing.

- The kneading consists of mixing the previously prepared and milled raw materials with water. This results in a paste that is easily malleable by extrusion.

- The shaping is carried out by placing the plastic paste in the extruder, which is kneaded and pushed through the nozzle by vacuum pressure in order to obtain the final pieces. This process results in special pieces such as steps or pool edging, etc.

- Later, the moulded pieces are subjected to hot air in order to eliminate any humidity.

- They are then fired at high temperatures, obtaining perfect vitrification of the same.

With this process, the materials can be fully recycled and accept up to 45% of recycled material in their standard process.

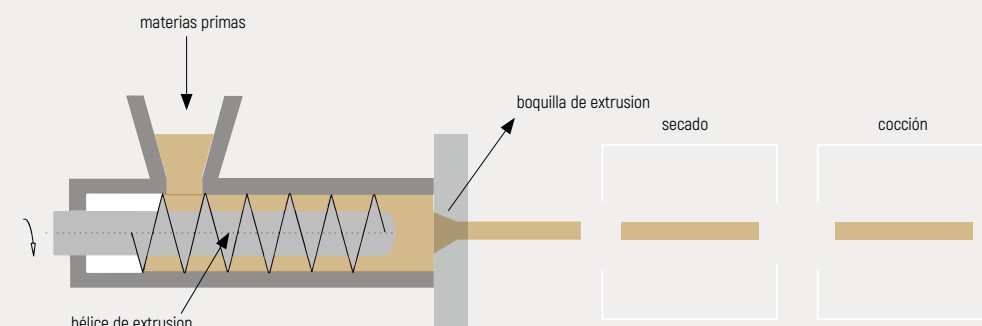

PROCESO DE EXTRUSIÓN - EXTRUSION PROCESS

L'extrusion est une technique de mise en forme pour la fabrication de produits en céramique. Le procédé d'extrusion consiste essentiellement à forcer le passage, à travers l'application d'une pression, de la pâte à consistance plastique à travers une matrice. La fabrication de carreaux par le procédé d'extrusion se compose de quatre phases principales : malaxage, mise en forme, séchage et cuisson.

- le malaxage consiste à mélanger avec de l'eau les matières premières qui ont été préalablement préparées et moulues. Grâce à cela, on obtient une pâte que l'on peut facilement mouler par extrusion.

- la mise en forme se réalise en introduisant la pâte plastique dans une machine à extrusion. Cette pâte, sous la pression du vide, est malaxée et poussée à travers une filière pour obtenir les pièces finales.

Grâce à ce procédé, il est possible d'obtenir des pièces spéciales comme des marches ou des margelles de piscines, etc.

- ensuite, les pièces déjà moulues sont passées à l'air chaud afin d'éliminer le contenu d'humidité.

- puis, elles sont cuites à hautes températures, ce qui permet d'obtenir de ces dernières une parfaite vitrification.

Grâce à ce procédé, les matériaux peuvent être recyclés dans leur totalité et permettent jusqu'à 45 % de matériaux recyclés dans leur procédé standard.

Экструзия – технология, используемая для формовки керамических изделий при их изготовлении. В основном процесс экструзии заключается в продавливании под давлением пастообразного сырья через формирующее отверстие.

Производство керамической плитки с помощью экструзии состоит из четырех основных этапов: замеса, формовки, сушки и обжига.

- Замес заключается в смешивании с водой предварительно подготовленного и измельченного сырья. Конечным результатом этого процесса является легко поддающаяся обработке паста для экструзии.

- Формовка представляет собой загрузку полученной при замесе пасты в экструдер, в котором она перемешивается под вакуумным давлением и проталкивается через сопло для формовки конечных изделий.

С помощью этого процесса можно получить специальные изделия, такие как ступени или бордюры для бассейнов и т. д.

- После этого, уже сформованные изделия проходят обработку горячим воздухом для удаления влаги.

- Затем они подвергаются высокотемпературному обжигу до достижения ими необходимой витрификации (стеклования).

С помощью этого процесса материалы могут быть полностью переработаны. В стандартном процессе допускается использование до 45 % переработанных материалов.

## EL VALOR DE LA EXTRUSIÓN

THE VALUE OF EXTRUSION · LA VALEUR DE L'EXTRUSION · Преимущества экструзии

Las materias primas seleccionadas y el cuidado proceso de producción con las tecnologías más avanzadas y la labor de nuestro equipo humano, hacen que el producto obtenido posea unas características técnicas excepcionales. Con este proceso se pueden obtener geometrías tridimensionales en las piezas, imposibles de conseguir con el proceso de prensado tradicional.

The raw materials selected, the careful production process with the most advanced technologies, and the work of our human team mean that the product obtained has exceptional technical characteristics.

With this process, three-dimensional geometries can be obtained on the pieces which are impossible to achieve with the traditional compacting process

Les matières premières choisies, le rigoureux procédé de production qui utilise les technologies les plus avancées, ainsi que le travail de notre équipe humaine font que le produit obtenu possède des caractéristiques techniques exceptionnelles.





Grâce à ce procédé, on peut obtenir des géométries tridimensionnelles sur les pièces, impossibles à réaliser avec le procédé de pressage traditionnel.







Благодаря отборному сырью и тщательному процессу производства с использованием самых передовых технологий и работе нашего коллектива полученные изделия обладают исключительными техническими характеристиками.

Этот процесс позволяет изготавливать трехмерные изделия, что невозможно при использовании традиционного процесса прессования.













Gres extruido de pasta blanca de baja absorción de agua, según UNE-EN 14411, grupo Alb, esmaltado.  
White body extruded stoneware with low water absorption, according to EN 14411, group Alb, glazed.

COLECCIÓN	ABSORCIÓN DE AGUA WATER ABSORPTION ABSORPTION D'EAU ВОДОПОГЛОЩЕНИЕ	RESISTENCIA A LA FLEXIÓN MODULUS OF RUPTUR RÉSISTANCE À LA FLEXION СОПРОТИВЛЕНИЕ НА ИЗГИБ	RESISTENCIA A LA ABRASIÓN (PEI) DEEP ABRASION RESISTANCE RÉSISTANCE À L'ABRASION СТОЙКОСТЬ К ИСТИРАНИЮ ПОВЕРХНОСТИ	RESISTENCIA AL CHOQUE TÉRMICO THERMAL SHOCK RESISTANCE RÉSIST. AUX VARIATIONS THERMIQUES СТОЙКОСТЬ К ТЕПЛОВЫМ ПЕРЕПАДАМ	RESISTENCIA AL CUARTEO CRACKING RESISTANCE RÉSISTANCE AU TRESSAILLAGE УСТОЙЧИВОСТЬ К РАСТРЕСКИВАНИЮ
					
	ISO 10545-3	ISO 10545-4	ISO 10545-7	ISO 10545-9	ISO 10545-11
IMPERIAL	< 1,5%	>30 N/mm <sup>2</sup> >1800 N	4	garantizado guaranteed garanti Гарантированно	garantizado guaranteed garanti Гарантированно
NUBIA	< 1,5%	>30 N/mm <sup>2</sup> >1800 N	4	garantizado guaranteed garanti Гарантированно	garantizado guaranteed garanti Гарантированно
VENATTO	< 1,5%	>30 N/mm <sup>2</sup> >1800 N	4	garantizado guaranteed garanti Гарантированно	garantizado guaranteed garanti Гарантированно
MARKINA	< 1,5%	>30 N/mm <sup>2</sup> >1800 N	5 bianco 1 nero	garantizado guaranteed garanti Гарантированно	garantizado guaranteed garanti Гарантированно
MARBLES	< 1,5%	>30 N/mm <sup>2</sup> >1800 N	5	garantizado guaranteed garanti Гарантированно	garantizado guaranteed garanti Гарантированно
LIZANA	< 1,5%	>30 N/mm <sup>2</sup> >1800N	2-3	garantizado guaranteed garanti Гарантированно	garantizado guaranteed garanti Гарантированно
YOHO	< 1,5%	>30 N/mm <sup>2</sup> >1800 N	4	garantizado guaranteed garanti Гарантированно	garantizado guaranteed garanti Гарантированно
NATURA	< 1,5%	>30 N/mm <sup>2</sup> >1800 N	4	garantizado guaranteed garanti Гарантированно	garantizado guaranteed garanti Гарантированно
ALHAMAR	< 1,5%	>30 N/mm <sup>2</sup> >1800 N	3	garantizado guaranteed garanti Гарантированно	garantizado guaranteed garanti Гарантированно
COSMOS	< 1,5%	>30 N/mm <sup>2</sup> >1800 N	3	garantizado guaranteed garanti Гарантированно	garantizado guaranteed garanti Гарантированно
ÓPERA	< 1,5%	>30 N/mm <sup>2</sup> >1800 N	4	garantizado guaranteed garanti Гарантированно	garantizado guaranteed garanti Гарантированно

RESISTENCIA A LA HELADA FROST RESISTANCE RÉSISTANCE AU GEL МОРОЗОСТОЙКОСТЬ	RESISTENCIA A LOS AGENTES QUÍMICOS CHEMICAL RESISTANCE RÉSISTANCE AUX PRODUITS CHIMIQUES СТОЙКОСТЬ К ВОЗДЕЙСТВИЮ ХИМИКАТОВ	RESISTENCIA A LAS MANCHAS STAIN RESISTANCE RÉSISTANCE AUX TACHES УСТОЙЧИВОСТЬ К ОБРАЗОВАНИЮ ПЯТЕН	RESISTENCIA AL DESLIZAMIENTO (rampa pie calzado) ANTI-SLIP RESISTANCE (ramp) RÉSISTANCE AU GLISSEMENT (pied chaussé) СОПРОТИВЛЕНИЕ СКОЛЬЖЕНИЮ (если ходит обувью)	RESISTENCIA AL DESLIZAMIENTO (C.T.E.) ANTI-SLIP RESISTANCE RÉSISTANCE AU GLISSEMENT (C.T.E.) СОПРОТИВЛЕНИЕ СКОЛЬЖЕНИЮ (C.T.E.)	RESISTENCIA AL DESLIZAMIENTO (pie descalzo) ANTI-SLIP RESISTANCE (bare foot) RÉSISTANCE AU GLISSEMENT (pied nu) СОПРОТИВЛЕНИЕ СКОЛЬЖЕНИЮ (босые ноги)
					
ISO 10545-12	ISO 10545-13	ISO 10545-14	DIN 51130	UNE 41901 EX	DIN 51097
garantizado guaranteed garanti Гарантированно	A - LA - HA	CLASE 5	R9 normal R11 anti-slip	CLASE 1 norma CLASE 3 anti-slip	- CLASE C anti-slip
garantizado guaranteed garanti Гарантированно	A - LA - HA	CLASE 5	R9 normal R11 anti-slip	CLASE 1 normal CLASE 3 anti-slip	- CLASE C anti-slip
garantizado guaranteed garanti Гарантированно	A - LA - HA	CLASE 5	R9 normal R11 anti-slip	CLASE 1 normal CLASE 3 anti-slip	- CLASE C anti-slip
garantizado guaranteed garanti Гарантированно	A - LA - HA	CLASE 5	R10 normal R11 anti-slip	CLASE 1 normal CLASE 3 anti-slip	- -
garantizado guaranteed garanti Гарантированно	A - LA - HA	CLASE 5	R9 normal R11 anti-slip	CLASE 1 normal CLASE 3 anti-slip	- CLASE C anti-slip
garantizado guaranteed garanti Гарантированно	A - LA - HA	CLASE 5	R9 normal R12 anti-slip	CLASE 1 normal CLASE 3 anti-slip	- CLASE C anti-slip
garantizado guaranteed garanti Гарантированно	A - LA - HA	CLASE 5	R9 normal R11 anti-slip	CLASE 1 normal CLASE 3 anti-slip	- CLASE C anti-slip
garantizado guaranteed garanti Гарантированно	A - LA - HA	CLASE 5	R11	CLASE 3	CLASE C
garantizado guaranteed garanti Гарантированно	A - LA - HA	CLASE 5	R9 normal R12 anti-slip	CLASE 1 normal CLASE 3 anti-slip	- -
garantizado guaranteed garanti Гарантированно	A - LA - HA	CLASE 5	R9 normal R11 anti-slip	CLASE 1 normal CLASE 3 anti-slip	- -
garantizado guaranteed garanti Гарантированно	A - LA - HA	CLASE 5	R9 normal R12 anti-slip	CLASE 1 normal CLASE 3 anti-slip	- -

Gres extruido de pasta blanca de baja absorción de agua, según UNE-EN 14411, grupo Alb, esmaltado.  
White body extruded stoneware with low water absorption, according to EN 14411, group Alb, glazed.

COLECCIÓN	ABSORCIÓN DE AGUA WATER ABSORPTION ABSORPTION D'EAU ВОДОПОГЛОЩЕНИЕ	RESISTENCIA A LA FLEXIÓN MODULUS OF RUPTUR RÉSISTANCE À LA FLEXION СОПРОТИВЛЕНИЕ НА ИЗГИБ	RESISTENCIA A LA ABRASIÓN (PEI) DEEP ABRASION RESISTANCE RÉSISTANCE À L'ABRASION СТОЙКОСТЬ К ИСТИРАНИЮ ПОВЕРХНОСТИ	RESISTENCIA AL CHOQUE TÉRMICO THERMAL SHOCK RESISTANCE RÉSIST. AUX VARIATIONS THERMIQUES СТОЙКОСТЬ К ТЕПЛОВЫМ ПЕРЕПАДАМ	RESISTENCIA AL CUARTEO CRACKING RESISTANCE RÉSISTANCE AU TRESSAILLAGE УСТОЙЧИВОСТЬ К РАСТРЕСКИВАНИЮ
					
	ISO 10545-3	ISO 10545-4	ISO 10545-7	ISO 10545-9	ISO 10545-11
MEDITERRÁNEO	< 1,5%	>30 N/mm <sup>2</sup> >1800 N	2 grafito 4 arena	garantizado guaranteed garanti Гарантированно	garantizado guaranteed garanti Гарантированно
ARDENAS	< 1,5%	>30 N/mm <sup>2</sup> >1800 N	4 marfil / cromo / gris 2 antracita	garantizado guaranteed garanti Гарантированно	garantizado guaranteed garanti Гарантированно
MILÁN	< 1,5%	>30 N/mm <sup>2</sup> >1800 N	4 arena / gris 3 marengo	garantizado guaranteed garanti Гарантированно	garantizado guaranteed garanti Гарантированно
ALBAROC	< 1,5%	>30 N/mm <sup>2</sup> >1800 N	4 hulla 5 boal/galena	garantizado guaranteed garanti Гарантированно	garantizado guaranteed garanti Гарантированно
LITOS	< 1,5%	>30 N/mm <sup>2</sup> >1800 N	4	garantizado guaranteed garanti Гарантированно	garantizado guaranteed garanti Гарантированно
MANHATTAN	< 1,5%	>30 N/mm <sup>2</sup> >1800N	4	garantizado guaranteed garanti Гарантированно	garantizado guaranteed garanti Гарантированно
PETRA	< 1,5%	>30 N/mm <sup>2</sup> >1800 N	4	garantizado guaranteed garanti Гарантированно	garantizado guaranteed garanti Гарантированно
VEGA	< 1,5%	>30 N/mm <sup>2</sup> >1800 N	2 rojo/rojo anti-slip 3 ocre/visón 4 ocre anti-slip/gris 5 gris anti-slip/visón anti-slip	garantizado guaranteed garanti Гарантированно	garantizado guaranteed garanti Гарантированно
METÁLICA	< 1,5%	>30 N/mm <sup>2</sup> >1800 N	3	garantizado guaranteed garanti Гарантированно	garantizado guaranteed garanti Гарантированно

RESISTENCIA A LA HELADA FROST RESISTANCE RÉSISTANCE AU GEL МОРОЗОСТОЙКОСТЬ	RESISTENCIA A LOS AGENTES QUÍMICOS CHEMICAL RESISTANCE RÉSISTANCE AUX PRODUITS CHIMIQUES СТОЙКОСТЬ К ВОЗДЕЙСТВИЮ ХИМИКАТОВ	RESISTENCIA A LAS MANCHAS STAIN RESISTANCE RÉSISTANCE AUX TACHES УСТОЙЧИВОСТЬ К ОБРАЗОВАНИЮ ПЯТЕН	RESISTENCIA AL DESLIZAMIENTO (rampa pie calzado) ANTI-SLIP RESISTANCE (ramp) RÉSISTANCE AU GLISSEMENT (pied chaussé) СОПРОТИВЛЕНИЕ СКОЛЬЖЕНИЮ (если ходит обувью)	RESISTENCIA AL DESLIZAMIENTO (C.T.E.) ANTI-SLIP RESISTANCE RÉSISTANCE AU GLISSEMENT (C.T.E.) СОПРОТИВЛЕНИЕ СКОЛЬЖЕНИЮ (C.T.E.)	RESISTENCIA AL DESLIZAMIENTO (pie descalzo) ANTI-SLIP RESISTANCE (bare foot) RÉSISTANCE AU GLISSEMENT (pied nu) СОПРОТИВЛЕНИЕ СКОЛЬЖЕНИЮ (босые ноги)
					
ISO 10545-12	ISO 10545-13	ISO 10545-14	DIN 51130	UNE 41901 EX	DIN 51097
garantizado guaranteed garanti Гарантированно	A - LA - HA	CLASE 5	R9 normal R11 anti-slip	CLASE 1 norma CLASE 3 anti-slip	- -
garantizado guaranteed garanti Гарантированно	A - LA - HA	CLASE 5	R9 normal R12 anti-slip	CLASE 1 normal CLASE 3 anti-slip	- CLASE C anti-slip
garantizado guaranteed garanti Гарантированно	A - LA - HA	CLASE 5	R9 normal R12 anti-slip	CLASE 1 normal CLASE 3 anti-slip	- CLASE C anti-slip
garantizado guaranteed garanti Гарантированно	A - LA - HA	CLASE 5	R10 normal R12 anti-slip	CLASE 1 normal CLASE 3 anti-slip	- CLASE C anti-slip
garantizado guaranteed garanti Гарантированно	A - LA - HA	CLASE 5	R9 normal R12 anti-slip	CLASE 1 normal CLASE 3 anti-slip	- CLASE C anti-slip
garantizado guaranteed garanti Гарантированно	A - LA - HA	CLASE 5	R11	CLASE 2	-
garantizado guaranteed garanti Гарантированно	A - LA - HA	CLASE 5	R12	CLASE 3	CLASE C
garantizado guaranteed garanti Гарантированно	A - LA - HA	CLASE 5	R9 normal R10 anti-slip	CLASE 1 normal CLASE 2 anti-slip	- -
garantizado guaranteed garanti Гарантированно	A - LB - HB	CLASE 5	R9	CLASE 1	-

**Gres Porcelánico de pasta blanca, según UNE-EN 14411; Grupo B1a, esmaltado.**

Dust pressed White body porcelain tile, according to EN 14411, group B1a, glazed.

Grès cérame à pâte blanche, selon la norme EN 14411, Groupe B1a, émaillé.

Керамогранит из белой глины, в соответствии с EN 14411; группа B1a, глазурованный.

NORMA · TEST	DESCRIPCIÓN · DESCRIPTION	REQUISITOS · STANDARDS
ISO 10545-2	 Dimensiones / Sizes Longitud y anchura / Length and width Espesor / Thickness Rectitud de los lados / Straightness of sides Ortogonalidad / Rectangularity Planaridad / Surface Flatness	± 0,6% ± 2 mm ± 5,0% ± 0,5 mm ± 0,5% ± 1,5 mm ± 0,5% ± 2 mm ± 0,5% ± 2 mm
ISO 10545-3	 Absorción de agua / Water absorption	< 0,5 %
ISO 10545-4	 Fuerza de rotura / Breaking strength	≥ 1300 N
ISO 10545-4	 Resistencia a la flexión / Modulus of rupture	≥ 35 N/mm <sup>2</sup>
ISO 10545-7	 Resistencia a la abrasión superficial / Resistance to surface abrasion	1-5
ISO 10545-9	 Resistencia al choque térmico / Resistance to thermal shock	exigida / required
ISO 10545-11	 Resistencia al cuarteo / Crazing resistance	exigida / required
ISO 10545-12	 Resistencia a la helada / Frost resistance	exigida / required
ISO 10545-13	 Resistencia a los agentes químicos / Chemical resistance	mínimo B minimum B
ISO 10545-14	 Resistencia a las manchas / Stain resistance	mínimo clase 3 / minimum class 3
UNE 41901 EX	 Resistencia al deslizamiento (péndulo). Exigida C.T.E. / Slip Resistance (pendulum) C.T.E. required	Exigida C.T.E. / C.T.E. required
DIN 51130	 Resistencia al deslizamiento (rampa pie calzado) Anti-slip resistance (ramp)	-
DIN 51097	 Resistencia al deslizamiento (pie descalzo) Anti-slip resistance (barefoot)	-

IMPERIAL	VENATTO	NUBIA	OROBICO	MARBLES	MARKINA	LIZANA
bases 120x120 - 60x120 - 14,5x120 - 60x60 - 33x66,5	bases 120x120 - 60x120 - 14,5x120 - 33x66,5	bases 60x120 - 33x66,5	bases 60x120 - 14,5x120	bases 60x120 - 14,5x120	bases 100x100 - 60x120 - 14,5x120	bases 25x150 - 20x120 - 14,5x120
garantizado / guaranteed	garantizado / guaranteed	garantizado / guaranteed	garantizado / guaranteed	garantizado / guaranteed	garantizado / guaranteed	garantizado / guaranteed
< 0,5 %	< 0,5 %	< 0,5 %	< 0,5 %	< 0,5 %	< 0,5 %	< 0,5 %
> 1300 N	> 1300 N	> 1300 N	> 1300 N	> 1300 N	> 1300 N	> 1300 N
> 35 N/mm <sup>2</sup>	> 35 N/mm <sup>2</sup>	> 35 N/mm <sup>2</sup>	> 35 N/mm <sup>2</sup>	> 35 N/mm <sup>2</sup>	> 35 N/mm <sup>2</sup>	> 35 N/mm <sup>2</sup>
4	4	4	4	5	5 blanco 1 nero	3
garantizado / guaranteed	garantizado / guaranteed	garantizado / guaranteed	garantizado / guaranteed	garantizado / guaranteed	garantizado / guaranteed	garantizado / guaranteed
garantizado / guaranteed	garantizado / guaranteed	garantizado / guaranteed	garantizado / guaranteed	garantizado / guaranteed	garantizado / guaranteed	garantizado / guaranteed
garantizado / guaranteed	garantizado / guaranteed	garantizado / guaranteed	garantizado / guaranteed	garantizado / guaranteed	garantizado / guaranteed	garantizado / guaranteed
A-LA-HA	A-LA-HA	A-LA-HA	A-LA-HA	A-LA-HA	A-LA-HA	A-LA-HA
clase 5 / class 5	clase 5 / class 5	clase 5 / class 5	clase 5 / class 5	clase 5 / class 5	clase 5 / class 5	clase 5 / class 5
Normal - clase 1 / class 1 Anti-slip - clase 3 / class 3	Normal - clase 1 / class 1 Anti-slip - clase 3 / class 3	Normal - clase 1 / class 1 Anti-slip - clase 3 / class 3	clase 1 / class 1	clase 1 / class 1	Normal - clase 1 / class 1 Anti-slip - clase 3 / class 3	Normal - clase 1 / class 1 Anti-slip - clase 3 / class 3
Normal - R9 Anti-slip - R11	Normal - R9 Anti-slip - R11	Normal - R9 Anti-slip - R11	-	-	Normal - R9 Anti-slip - R11	Normal - R9 Anti-slip - R12
Anti-slip clase c / class c	Anti-slip clase c / class c	Anti-slip clase c / class c	-	-		Anti-slip clase c / class c

**Gres Porcelánico de pasta blanca, según UNE-EN 14411; Grupo B1a, esmaltado.**

White body porcelain tile, according to EN 14411, group B1a, glazed.

Grès cérame à pâte blanche, selon la norme EN 14411, Groupe B1a, émaillé.

Керамогранит из белой глины, в соответствии с EN 14411; группа B1a, глазурованный.

NORMA · TEST	DESCRIPCIÓN · DESCRIPTION	REQUISITOS · STANDARDS
ISO 10545-2	 Dimensiones / Sizes Longitud y anchura / Length and width Espesor / Thickness Rectitud de los lados / Straightness of sides Ortogonalidad / Rectangularity Planaridad / Surface Flatness	± 0,6% ± 2 mm ± 5,0% ± 0,5 mm ± 0,5% ± 1,5 mm ± 0,5% ± 2 mm ± 0,5% ± 2 mm
ISO 10545-3	 Absorción de agua / Water absorption	< 0,5 %
ISO 10545-4	 Fuerza de rotura / Breaking strength	≥ 1300 N
ISO 10545-4	 Resistencia a la flexión / Modulus of rupture	≥ 35 N/mm <sup>2</sup>
ISO 10545-7	 Resistencia a la abrasión superficial / Resistance to surface abrasion	1-5
ISO 10545-9	 Resistencia al choque térmico / Resistance to thermal shock	exigida / required
ISO 10545-11	 Resistencia al cuarteo / Crazing resistance	exigida / required
ISO 10545-12	 Resistencia a la helada / Frost resistance	exigida / required
ISO 10545-13	 Resistencia a los agentes químicos / Chemical resistance	mínimo B minimum B
ISO 10545-14	 Resistencia a las manchas / Stain resistance	mínimo clase 3 / minimum class 3
UNE 41901 EX	 Resistencia al deslizamiento (péndulo). Exigida C.T.E. / Slip Resistance (pendulum) C.T.E. required	Exigida C.T.E. / C.T.E. required
DIN 51130	 Resistencia al deslizamiento (rampa pie calzado) Anti-slip resistance (ramp)	-
DIN 51097	 Resistencia al deslizamiento (pie descalzo) Anti-slip resistance (barefoot)	-

YOHO bases 25x150 - 14,5x120	ARDENAS bases 120x120 - 60x120 - 14,5x120 - 33x66,5	MILÁN bases 75x75 - 14,5x120	ALBAROC bases 100x100 - 14,5x120	LITOS bases 100x100 - 60x120 - 14,5x120	COSMOS bases 120x120 - 60x120 - 14,5x120 - 33x66,5	ÓPERA bases 120x120 - 60x120 - 14,5x120
garantizado / guaranteed	garantizado / guaranteed	garantizado / guaranteed	garantizado / guaranteed	garantizado / guaranteed	garantizado / guaranteed	garantizado / guaranteed
< 0,5 %	< 0,5 %	< 0,5 %	< 0,5 %	< 0,5 %	< 0,5 %	< 0,5 %
> 1300 N	> 1300 N	> 1300 N	> 1300 N	> 1300 N	> 1300 N	> 1300 N
> 35 N/mm <sup>2</sup>	> 35 N/mm <sup>2</sup>	> 35 N/mm <sup>2</sup>	> 35 N/mm <sup>2</sup>	> 35 N/mm <sup>2</sup>	> 35 N/mm <sup>2</sup>	> 35 N/mm <sup>2</sup>
5	4 marfil / cromo / gris 2 antracita	4 arena / gris 5 marengo	4 hulla 5 boal / galena	4	3	4
garantizado / guaranteed	garantizado / guaranteed	garantizado / guaranteed	garantizado / guaranteed	garantizado / guaranteed	garantizado / guaranteed	garantizado / guaranteed
garantizado / guaranteed	garantizado / guaranteed	garantizado / guaranteed	garantizado / guaranteed	garantizado / guaranteed	garantizado / guaranteed	garantizado / guaranteed
garantizado / guaranteed	garantizado / guaranteed	garantizado / guaranteed	garantizado / guaranteed	garantizado / guaranteed	garantizado / guaranteed	garantizado / guaranteed
A-LA-HA	A-LA-HA	A-LA-HA	A-LA-HA	A-LA-HA	A-LA-HA	A-LA-HA
clase 5 / class 5	clase 5 / class 5	clase 5 / class 5	clase 5 / class 5	clase 5 / class 5	clase 5 / class 5	clase 5 / class 5
Normal - clase 1 / class 1 Anti-slip - clase 3 / class 3	Normal - clase 1 / class 1 Anti-slip - clase 3 / class 3	Normal - clase 1 / class 1 Anti-slip - clase 3 / class 3	Normal - clase 1 / class 1 Anti-slip - clase 3 / class 3	Normal - clase 1 / class 1 Anti-slip - clase 3 / class 3	Normal - clase 1 / class 1 Anti-slip - clase 3 / class 3	Normal - clase 1 / class 1 Anti-slip - clase 3 / class 3
Normal - R9 Anti-slip - R11	Normal - R9 Anti-slip - R12	Normal - R9 Anti-slip - R12	Normal - R10 Anti-slip - R12	Normal - R9 Anti-slip - R12	Normal - R9 Anti-slip - R11	Normal - R9 Anti-slip - R12
Anti-slip clase c / class c	Anti-slip clase c / class c	Anti-slip clase c / class c	-	Anti-slip clase c / class c	-	Anti-slip clase c / class c

## MARBLE

IMPERIAL	PIEZAS · PIECES · DES MORCEAUX · ЧАСТЕЙ	CAJAS · BOXES · BOITES · КОРОБКИ	PALETS · PALLETS · PALLETES · ПАЛЛЕТЫ	MEDIDAS DE FABRICACIÓN · MANUFACTURING MEASURES
Base 120x120 cm - 10 mm	0,69 pcs / m <sup>2</sup>	1 pcs. / 34,35 Kg	38 boxes / 1.306 Kg	1198x1198 mm
Base 60x120 cm - 10 mm	1,39 pcs / m <sup>2</sup>	2 pcs. / 38,50 Kg	27 boxes / 1.040 Kg	598x1198 mm
Base 14,5x120 cm - 10 mm	5,75 pcs / m <sup>2</sup>	4 pcs. / 17,20 Kg	64 boxes / 1.100 Kg	145x1198 mm
Base 60x60 cm - 10,3 mm	2,77 pcs / m <sup>2</sup>	4 pcs. / 32 Kg	30 boxes / 960 Kg	-
Base 60x60 cm - 9,4 mm	2,77 pcs / m <sup>2</sup>	3 pcs. / 23,4 Kg	40 boxes / 936 Kg	596x596 mm
Base 33x66,5 cm - 10 mm	4,5 pcs. / m <sup>2</sup>	5 pcs. / 25,38 Kg	40 boxes / 1.015 Kg	-
Peldaño recto 33x120x3 cm - 12 mm	0,83 pcs / ml	2 pcs. / 25,90 Kg	11 boxes / 285 Kg	-
Remate peldaño recto 3x33 cm	-	20 pcs. / 3,2 Kg	92 boxes / 295 Kg	-
Zanquin ingletado recto izda/dcha 59,6x59,6 cm	-	9 pcs. / 19,8 Kg	56 boxes / 1.109 Kg	-
Peldaño ML 120 33x120x4 cm - 13 mm	0,83 pcs. / ml	2 pcs. / 28 Kg	10 boxes / 280 Kg	-
Remate ML 4x33 cm	-	20 pcs. / 3,2 Kg	92 boxes / 295 Kg	-
Zanquin ingletado ML izda/dcha 59,6x59,6 cm	-	9 pcs. / 19,8 Kg	56 boxes / 1.109 Kg	-
Rodapié 9x60 cm - 11 mm	1,66 pcs / ml	18 pcs. / 19,80 Kg	56 boxes / 1.109 Kg	-
Borde Skimmer 45x75 cm	1,33 pcs. / ml	2 pcs. / 30 Kg	29 boxes / 870 Kg	-
Borde desbordante 28x66,5 cm	1,5 pcs. / ml	2 pcs. / 13,60 Kg	72 boxes / 980 Kg	-
Ángulo borde desbordante 31x31 cm	-	1 pcs. / 4,30 Kg	92 boxes / 396 Kg	-
Rejilla 24,5x24,5 cm	4 pcs. / ml	6 pcs. / 15,78 Kg	57 boxes / 900 Kg	-
Ángulo rejilla izda/dcha. 24,5x33 cm	-	1 pcs. / 4,50 Kg	82 boxes / 369 Kg	-
Media caña 33x4 cm - r-3	3 pcs. / ml	52 pcs. / 13 Kg	64 boxes / 832 Kg	33x4,2
Uña 4x4 cm	-	4 pcs. / 0,4 Kg	72 boxes / 30 Kg	4,2x4,2
Arista 33x3 cm - r-3	3 pcs. / ml	70 pcs. / 13 Kg	64 boxes / 832 Kg	33x3,3
Uña arista 3x3 cm	-	4 pcs. / 0,4 Kg	72 boxes / 30 Kg	3,3x3,3
Ángulo exterior arista 5x5 cm	-	8 pcs. / 0,43 Kg	72 boxes / 32 Kg	-
Ángulo interior arista 5x5 cm	-	8 pcs. / 0,43 Kg	72 boxes / 32 Kg	-

NUBIA	PIEZAS · PIECES · DES MORCEAUX · ЧАСТЕЙ	CAJAS · BOXES · BOITES · КОРОБКИ	PALETS · PALLETS · PALLETES · ПАЛЛЕТЫ	MEDIDAS DE FABRICACIÓN · MANUFACTURING MEASURES
Base 60x120 cm - 10,2 mm	1,39 pcs / m <sup>2</sup>	2 pcs. / 36,5 Kg	27 boxes / 987 Kg	-
Base 60x120 cm - 10 mm	1,39 pcs / m <sup>2</sup>	2 pcs. / 33,82 Kg	32 boxes / 1.082 Kg	-
Base 33x66,5 cm - 10 mm	4,5 pcs. / m <sup>2</sup>	5 pcs. / 25,38 Kg	40 boxes / 1.015 Kg	-
Peldaño recto 33x120x4 cm - 12 mm	0,83 pcs / ml	2 pcs. / 25,90 Kg	11 boxes / 285 Kg	-
Media caña 33x4 cm - r-3	3 pcs / ml	52 pcs. / 13 Kg	64 boxes / 832 Kg	33x4,2
Uña 4x4 cm	-	4 pcs. / 0,4 Kg	72 boxes / 30 Kg	4,2x4,2
Arista 33x3 cm - r-3	3 pcs / ml	70 pcs. / 13 Kg	64 boxes / 832 Kg	33x3,3
Uña arista 3x3 cm	-	4 pcs. / 0,4 Kg	72 boxes / 30 Kg	3,3x3,3

## MARBLE

VENATTO	PIEZAS · PIECES · DES MORCEAUX · ЧАСТЕЙ	CAJAS · BOXES · BOITES · КОРОБКИ	PALETS · PALLETS · PALLETES · ПАЛЛЕТЫ	MEDIDAS DE FABRICACIÓN · MANUFACTURING MEASURES
Base 120x120 cm - 10 mm	0,69 pcs / m <sup>2</sup>	1 pcs. / 34,35 Kg	38 boxes / 1.306 Kg	1198x1198 mm
Base 60x120 cm - 10 mm	1,39 pcs / m <sup>2</sup>	2 pcs. / 38,50 Kg	27 boxes / 1.040 Kg	598x1198 mm
Base 14,5x120 cm - 10 mm	5,75 pcs / m <sup>2</sup>	4 pcs. / 17,20 Kg	64 boxes / 1.100 Kg	145x1198 mm
Base 33x66,5 cm - 10 mm	4,5 pcs. / m <sup>2</sup>	5 pcs. / 25,38 Kg	40 boxes / 1.015 Kg	-
Peldaño ML 120 33x120x4 cm - 13 mm	0,83 pcs. / m <sup>2</sup>	2 pcs. / 28 Kg	10 boxes / 280 Kg	-
Remate ML 4x33 cm	-	20 pcs. / 3,2 Kg	92 boxes / 295 Kg	-
Zanquin ingletado ML izda/dcha 59,6x59,6 cm	-	9 pcs. / 19,8 Kg	56 boxes / 1.109 Kg	-
Rodapié 9x60 cm - 11 mm	1,66 pcs / ml	18 pcs. / 19,80 Kg	56 boxes / 1.109 Kg	-
Borde Skimmer 45x75 cm	1,33 pcs. / ml	2 pcs. / 30 Kg	29 boxes / 870 Kg	-
Borde desbordante 28x66,5 cm	1,5 pcs. / ml	2 pcs. / 13,60 Kg	72 boxes / 980 Kg	-
Ángulo borde desbordante 31x31 cm	-	1 pcs. / 4,30 Kg	92 boxes / 396 Kg	-
Rejilla 24,5x24,5 cm	4 pcs. / ml	6 pcs. / 15,78 Kg	57 boxes / 900 Kg	-
Ángulo rejilla izda/dcha 24,5x33 cm	-	1 pcs. / 4,50 Kg	82 boxes / 369 Kg	-
Media caña 33x4 cm - r-3	3 pcs. / ml	52 pcs. / 13 Kg	64 boxes / 832 Kg	33x4,2
Uña 4x4 cm	-	4 pcs. / 0,4 Kg	72 boxes / 30 Kg	4,2x4,2
Arista 33x3 cm - r-3	3 pcs. / ml	70 pcs. / 13 Kg	64 boxes / 832 Kg	33x3,3
Uña arista 3x3 cm	-	4 pcs. / 0,4 Kg	72 boxes / 30 Kg	3,3x3,3
Ángulo exterior arista 5x5 cm	-	8 pcs. / 0,43 Kg	72 boxes / 32 Kg	-
Ángulo interior arista 5x5 cm	-	8 pcs. / 0,43 Kg	72 boxes / 32 Kg	-

OROBICO	PIEZAS · PIECES · DES MORCEAUX · ЧАСТЕЙ	CAJAS · BOXES · BOITES · КОРОБКИ	PALETS · PALLETS · PALLETES · ПАЛЛЕТЫ	MEDIDAS DE FABRICACIÓN · MANUFACTURING MEASURES
Base 60x120 cm - 10 mm	1,39 pcs / m <sup>2</sup>	2 pcs. / 36,5 Kg	32 boxes / 1.082 Kg	-
Base 14,5x120 cm - 10 mm	5,75 pcs / m <sup>2</sup>	4 pcs. / 18,48 Kg	64 boxes / 1100 Kg	-
Peldaño ML 120 33x120x4 cm - 13 mm	0,83 pcs. / ml	2 pcs. / 28 Kg	10 boxes / 280 Kg	-
Remate ML 4x33 cm	-	20 pcs. / 3,2 Kg	92 boxes / 295 Kg	-
Zanquin ingletado ML izda/dcha 59,6x59,6 cm	-	9 pcs. / 19,8 Kg	56 boxes / 1.109 Kg	-
Rodapié 9x60 cm - 11 mm	1,66 pcs / ml	18 pcs. / 19,80 Kg	56 boxes / 1.109 Kg	-

## MARBLE

MARBLES	PIEZAS · PIECES · DES MORCEAUX · ЧАСТЕЙ	CAJAS · BOXES · BOITES · КОРОБКИ	PALETS · PALLETS · PALLETES · ПАЛЛЕТЫ	MEDIDAS DE FABRICACIÓN · MANUFACTURING MEASURES
Base 60x120 cm - 10 mm	1,39 pcs / m <sup>2</sup>	2 pcs. / 36,5 Kg	32 boxes / 1.082 Kg	-
Base 14,5x120 cm - 10 mm	5,75 pcs / m <sup>2</sup>	4 pcs. / 18,48 Kg	64 boxes / 1.100 Kg	-
Base 33x66,5 cm - 10 mm	4,5 pcs. / m <sup>2</sup>	5 pcs. / 25,38 Kg	40 boxes / 1.015 Kg	-
Peldaño recto 33x120x3 cm - 12 mm	0,83 pcs / ml	2 pcs. / 25,90 Kg	11 boxes / 285 Kg	-
Peldaño fiorentino 33x120x3 cm - 12 mm	0,83 pcs / ml	2 pcs. / 25,90 Kg	11 boxes / 285 Kg	-
Peldaño recto 33x60x3 cm - 12 mm	1,66 pcs / ml	2 pcs. / 11,70 Kg	20 boxes / 234 Kg	-
Remate peldaño recto 3x33 cm	-	20 pcs. / 3,2 Kg	82 boxes / 263 Kg	-
Remate peldaño fiorentino 3x33 cm	-	20 pcs. / 3,2 Kg	82 boxes / 263 Kg	-
Zanquin recto izda/dcha 18x40 cm	-	6 pcs. / 15 Kg	57 boxes / 855 Kg	-
Zanquin fiorentino izda/dcha 18x40 cm	-	6 pcs. / 15 Kg	57 boxes / 855 Kg	-
Media caña 33x4 cm - r-3	3 pcs / ml	52 pcs. / 13 Kg	64 boxes / 832 Kg	33x4,2
Uña 4x4 cm	-	4 pcs. / 0,4 Kg	72 boxes / 30 Kg	4,2x4,2
Arista 33x3 cm - r-3	3 pcs / ml	70 pcs. / 13 Kg	64 boxes / 832 Kg	33x3,3
Uña arista 3x3 cm	-	4 pcs. / 0,4 Kg	72 boxes / 30 Kg	3,3x3,3
Rodapié 9x40 cm - 15 mm	2,5 pcs / ml	12 pcs. / 15 Kg	66 boxes / 990 Kg	-

MARKINA	PIEZAS · PIECES · DES MORCEAUX · ЧАСТЕЙ	CAJAS · BOXES · BOITES · КОРОБКИ	PALETS · PALLETS · PALLETES · ПАЛЛЕТЫ	MEDIDAS DE FABRICACIÓN · MANUFACTURING MEASURES
Base 62x120 cm - 11 mm	1,49 pcs / m <sup>2</sup>	2 pcs. / 36,06 Kg	32 boxes / 1.169 Kg	-
Base 14,5x120 cm - 11 mm	5,75 pcs / m <sup>2</sup>	4 pcs. / 18,48 Kg	64 boxes / 1.195 Kg	-
Peldaño recto 33x120x3 cm - 12 mm	0,83 pcs / ml	2 pcs. / 25,90 Kg	11 boxes / 285 Kg	-
Remate peldaño recto 3x33 cm	-	20 pcs. / 3,2 Kg	82 boxes / 263 Kg	-
Zanquin recto izda/dcha 18x40 cm	-	6 pcs. / 15 Kg	57 boxes / 855 Kg	-
Rodapié 9x40 cm - 15 mm	2,5 pcs / ml	12 pcs. / 15 Kg	66 boxes / 990 Kg	-

## WOOD

LIZANA	PIEZAS · PIECES · DES MORCEAUX · ЧАСТЕЙ	CAJAS · BOXES · BOITES · КОРОБКИ	PALETS · PALLETS · PALLETES · ПАЛЛЕТЫ	MEDIDAS DE FABRICACIÓN · MANUFACTURING MEASURES
Base 25x150 cm - 9 mm	2,72 pcs / m <sup>2</sup>	3 pcs. / 29,25 Kg	54 boxes / 1.360 Kg	-
Base 20x120 cm - 9 mm	4,17 pcs / m <sup>2</sup>	5 pcs. / 22,96 Kg	45 boxes / 1.054 Kg	195x1192 mm
Base 14,5x120 cm - 10,1 mm	5,75 pcs / m <sup>2</sup>	4 pcs. / 18,48 Kg	64 boxes / 1.195 Kg	-
Base 16,25x66,5 cm - 10 mm	9 pcs. / m <sup>2</sup>	10 pcs. / 25,30 Kg	40 boxes / 1.012 Kg	-
Peldaño recto 33x120x3 cm - 12 mm	0,83 pcs / ml	2 pcs. / 25,90 Kg	11 boxes / 285 Kg	-
Peldaño ML 150 33x150x4 cm - 12 mm	-	2 pcs. / 32,2 Kg	10 boxes / 322 Kg	-
Remate peldaño recto 3x33 cm	-	20 pcs. / 3,2 Kg	92 boxes / 295 Kg	-
Remate peldaño ML izda/dcha 4x33 cm	-	20 pcs. / 3,2 Kg	92 boxes / 295 Kg	-
Rodapié 9x60 cm - 11 mm	1,66 pcs / ml	18 pcs. / 19,80 Kg	56 boxes / 1.109 Kg	-
Zanquin ingletado recto 59,6x59,6 cm	-	9 pcs. / 19,80 Kg	56 boxes / 1.110 Kg	-
Zanquin ingletado ML izda/dcha 59,6x59,6 cm	-	9 pcs. / 19,80 Kg	56 boxes / 1.110 Kg	-
Borde desbordante 28x66,5 cm - 17/30 mm	1,5 pcs. / ml	2 pcs. / 13,60 Kg	72 boxes / 980 Kg	-
Rejilla 24,5x66,5 cm - 30 mm	1,5 pcs / ml	3 pcs. / 15,78 Kg	22 boxes / -	-
Ángulo desbordante 31x31 cm - 17/30 mm	-	1 pcs. / 3,90 Kg	92 boxes / 360 Kg	-
Ángulo rejilla izda/dcha* 24,5x33 cm - 30 mm	-	1 pcs. / 4,5 Kg	82 boxes / 369 Kg	-

\* Set de dos piezas / Set of two tiles / Set de deux pièces / Набор из двух штук.

YOHO	PIEZAS · PIECES · DES MORCEAUX · ЧАСТЕЙ	CAJAS · BOXES · BOITES · КОРОБКИ	PALETS · PALLETS · PALLETES · ПАЛЛЕТЫ	MEDIDAS DE FABRICACIÓN · MANUFACTURING MEASURES
Base 24,5x150 - 11 mm	2,72 pcs / m <sup>2</sup>	3 pcs. / 29,25 Kg	42 boxes / 1.230 Kg	-
Base 25x150 cm - 9 mm	2,72 pcs / m <sup>2</sup>	3 pcs. / 24,42 Kg	54 boxes / 1.360 Kg	-
Base 14,5x120 cm - 10,1 mm	5,75 pcs / m <sup>2</sup>	4 pcs. / 18,48 Kg	64 boxes / 1.195 Kg	-
Base 16,25x66,5 cm - 10 mm	9 pcs. / m <sup>2</sup>	10 pcs. / 25,30 Kg	40 boxes / 1.012 Kg	-
Peldaño recto 33x120x3 cm - 12 mm	0,83 pcs / ml	2 pcs. / 25,90 Kg	11 boxes / 285 Kg	-
Remate peldaño recto 3x33 cm	-	20 pcs. / 3,2 Kg	82 boxes / 263 Kg	-
Zanquin recto izda/dcha 42,3x17,5 cm (maple / teca)	-	14 pcs. / 10,0 Kg	54 boxes / 540 Kg	-
Zanquin ingletado recto 59,6x59,6 cm (natural / oak)	-	9 pcs. / 19,80 Kg	56 boxes / 1.110 Kg	-
Rodapié 9x60 cm - 11 mm	1,66 pcs / ml	18 pcs. / 19,80 Kg	56 boxes / 1.109 Kg	-
Borde Skimmer 45x75 cm	1,33 pcs. / ml	2 pcs. / 30 Kg	29 boxes / 870 Kg	-

NATURA	PIEZAS · PIECES · DES MORCEAUX · ЧАСТЕЙ	CAJAS · BOXES · BOITES · КОРОБКИ	PALETS · PALLETS · PALLETES · ПАЛЛЕТЫ	MEDIDAS DE FABRICACIÓN · MANUFACTURING MEASURES
Base 16,25x66,5 cm - 10 mm	9 pcs. / m <sup>2</sup>	10 pcs. / 25,30 Kg	40 boxes / 1.012 Kg	-
Rodapié 9x33 cm - 11 mm	3 pcs. / ml	24 pcs. / 13,92 Kg	68 boxes / 947 Kg	-
Peldaño Fiorentino 33x33x3 cm - 12 mm	3 pcs. / ml	4 pcs. / 12,49 Kg	56 boxes / 700 Kg	-
Cartabón Fiorentino 33x33x3 cm - 14 mm	-	1 pcs. / 4,00 Kg	92 boxes / 368 Kg	-
Zanquin Fiorent. izda/dcha 39,5x17,5 cm	-	14 pcs. / 10,00 Kg	54 boxes / 540 Kg	-
Borde piscina 28x66,5 cm	1,5 pcs. / ml	1 pcs. / 10,75 Kg	72 boxes / 774 Kg	-
Ángulo Interior 33x33 cm	-	1 pcs. / 4,80 Kg	92 boxes / 441 Kg	-
Ángulo exterior 28x28 cm	-	1 pcs. / 4,00 Kg	92 boxes / 368 Kg	-

## URBAN

COSMOS	PIEZAS · PIECES · DES MORCEAUX · ЧАСТЕЙ	CAJAS · BOXES · BOITES · КОРОБКИ	PALETS · PALLETES · PALLETES · ПАЛЛЕТЫ	MEDIDAS DE FABRICACIÓN · MANUFACTURING MEASURES
Base 120x120 cm - 11 mm	0,69 pcs / m <sup>2</sup>	1 pcs. / 36,13 Kg	38 boxes / 1.373 Kg	-
Base 60x120 cm - 10,1 mm	1,39 pcs / m <sup>2</sup>	2 pcs. / 33,53 Kg	30 boxes / 1.006 Kg	-
Base 14,5x120 cm - 10,1 mm	5,75 pcs / m <sup>2</sup>	4 pcs. / 17,20 Kg	64 boxes / 1.195 Kg	-
Base 33x66,5 cm - 10 mm	9 pcs. / m <sup>2</sup>	10 pcs. / 25,30 Kg	40 boxes / 1.012 Kg	-
Peldaño Recto 120 33x120x3 cm - 12 mm	0,83 pcs. / ml	2 pcs. / 25,90 Kg	11 boxes / 285 Kg	-
Remate peldaño recto 3x33 cm	-	20 pcs. / 3,2 Kg	92 boxes / 295 Kg	-
Zanquin ingletado recto 59,6x59,6 cm	-	9 pcs. / 19,80 Kg	56 boxes / 1.110 Kg	-
Rodapié 9x60 cm - 11 mm	1,66 pcs. / ml	18 pcs. / 19,80 Kg	56 boxes / 1.109 Kg	-

ÓPERA	PIEZAS · PIECES · DES MORCEAUX · ЧАСТЕЙ	CAJAS · BOXES · BOITES · КОРОБКИ	PALETS · PALLETES · PALLETES · ПАЛЛЕТЫ	MEDIDAS DE FABRICACIÓN · MANUFACTURING MEASURES
Base 120x120 cm - 10 mm	0,69 pcs / m <sup>2</sup>	1 pcs. / 34,35 Kg	38 boxes / 1.306 Kg	1198x1198 mm
Base 60x120 cm - 10 mm	1,39 pcs / m <sup>2</sup>	2 pcs. / 38,50 Kg	27 boxes / 1.040 Kg	598x1198 mm
Base 60x120 cm - 10,1 mm	1,39 pcs / m <sup>2</sup>	2 pcs. / 33,50 Kg	30 boxes / 1.006 Kg	598x1198 mm
Base 14,5x120 cm - 10,1 mm	5,75 pcs / m <sup>2</sup>	4 pcs. / 17,20 Kg	64 boxes / 1.195 Kg	-
Base 33x66,5 cm - 10 mm	4,5 pcs. / m <sup>2</sup>	5 pcs. / 25,38 Kg	40 boxes / 1.015 Kg	-
Peldaño recto 33x120x3 cm - 12 mm	0,83 pcs / ml	2 pcs. / 25,90 Kg	11 boxes / 285 Kg	-
Remate peldaño recto 3x33 cm	-	20 pcs. / 3,2 Kg	82 boxes / 263 Kg	-
Zanquin recto izda/dcha 42,3x17,5 cm	-	14 pcs. / 10,0 Kg	54 boxes / 540 Kg	-
Rodapié 9x60 cm - 11 mm	1,66 pcs / ml	18 pcs. / 19,80 Kg	56 boxes / 1.109 Kg	-
Borde Skimmer 45x75 cm	1,33 pcs. / ml	2 pcs. / 30 Kg	29 boxes / 870 Kg	-
Borde desbordante 28x66,5 cm	1,5 pcs. / ml	2 pcs. / 13,60 Kg	72 boxes / 980 Kg	-
Ángulo borde desbordante 31x31 cm	-	1 pcs. / 4,30 Kg	92 boxes / 396 Kg	-
Rejilla 24,5x24,5 cm	4 pcs. / ml	6 pcs. / 15,78 Kg	57 boxes / 900 Kg	-
Ángulo rejilla izda/dcha 24,5x33 cm	-	1 pcs. / 4,50 Kg	82 boxes / 369 Kg	-
Media caña 33x4 cm - r-3	3 pcs. / ml	52 pcs. / 13 Kg	64 boxes / 832 Kg	33x4,2
Uña 4x4 cm	-	4 pcs. / 0,4 Kg	72 boxes / 30 Kg	4,2x4,2
Arista 33x3 cm - r-3	3 pcs. / ml	70 pcs. / 13 Kg	64 boxes / 832 Kg	33x3,3
Uña arista 3x3 cm	-	4 pcs. / 0,4 Kg	72 boxes / 30 Kg	3,3x3,3

## URBAN

MEDITERRÁNEO	PIEZAS · PIECES · DES MORCEAUX · ЧАСТЕЙ	CAJAS · BOXES · BOITES · КОРОБКИ	PALETS · PALLETES · PALLETES · ПАЛЛЕТЫ	MEDIDAS DE FABRICACIÓN · MANUFACTURING MEASURES
Base 33x33 cm - 10 mm	9 pcs. / m <sup>2</sup>	9 pcs. / 22,18 Kg	52 boxes / 1.153 Kg	-
Base 33x66,5 cm - 10 mm	4,5 pcs. / m <sup>2</sup>	5 pcs. / 25,38 Kg	40 boxes / 1.015 Kg	-
Rodapié 9x33 cm - 11 mm	3 pcs. / ml	24 pcs. / 13,92 Kg	68 boxes / 947 Kg	-
Vierteaguas 12x33x3 cm	3 pcs. / ml	16 pcs. / 18,05 Kg	52 boxes / 938 Kg	-
Peldaño Fiorentino 33x33x3 cm - 12 mm	3 pcs. / ml	4 pcs. / 12,49 Kg	56 boxes / 700 Kg	-
Cartabón Fiorentino 33x33x3 cm - 14 mm	-	1 pcs. / 4,00 Kg	92 boxes / 368 Kg	-
Zanquin Fior. izda/dcha 39,5x17,5 cm (grafito)	-	14 pcs. / 10,00 Kg	54 boxes / 540 Kg	-
Zanquin Ingletado Fior. izda/dcha 32,8x32,8 cm (arena)	-	12 pcs. / 16,66 Kg	68 boxes / 1.132 Kg	-
Peldaño Recto 33x33x3 cm - 12 mm	3 pcs. / ml	4 pcs. / 12,04 Kg	56 boxes / 674 Kg	-
Zanquin Recto izda/dcha 42,3x17,5	-	14 pcs. / 10,00 Kg	54 boxes / 540 Kg	-
Pasamanos 12,5x66,5x4 cm	1,5 pcs. / ml	5 pcs. / 18,80 Kg	26 boxes / 489 Kg	-
Pasamanos 15,5x66,5x4 cm	1,5 pcs. / ml	5 pcs. / 21,45 Kg	20 boxes / 430 Kg	-

## STONE

ARDENAS	PIEZAS · PIECES · DES MORCEAUX · ЧАСТЕЙ	CAJAS · BOXES · BOITES · КОРБОККИ	PALETS · PALLETES · PALLETES · ПАЛЛЕТЫ	MEDIDAS DE FABRICACIÓN · MANUFACTURING MEASURES
Base 120x120 cm - 11 mm	0,69 pcs / m <sup>2</sup>	1 pcs. / 36,13 Kg	38 boxes / 1.373 Kg	-
Base 60x120 cm - 10,1 mm	1,39 pcs / m <sup>2</sup>	2 pcs. / 33,53 Kg	30 boxes / 1.006 Kg	-
Base 14,5x120 cm - 10,1 mm	5,75 pcs / m <sup>2</sup>	4 pcs. / 17,20 Kg	64 boxes / 1.195 Kg	-
Base 60x120 cm - 20 mm espesorado	1,39 pcs / m <sup>2</sup>	1 pcs. / 46,35 Kg	27 boxes / 929 Kg	-
Base 33x66,5 cm - 10 mm	4,5 pcs. / m <sup>2</sup>	5 pcs. / 25,38 Kg	40 boxes / 1.015 Kg	-
Base 33x33cm - 10 mm	9 pcs. / m <sup>2</sup>	9 pcs. / 22,18 Kg	52 boxes / 1.153 Kg	-
Base 16,25x33 cm - 10 mm	18 pcs. / m <sup>2</sup>	18 pcs. / 21,60 Kg	56 boxes / 1.210 Kg	-
Base 16,25x16,25 cm - 10 mm	36 pcs. / m <sup>2</sup>	18 pcs. / 10,80 Kg	112 boxes / 1.210 Kg	-
Peldaño recto 120 33x120x3 cm - 12 mm	0,83 pcs / ml	2 pcs. / 25,90 Kg	11 boxes / 285 Kg	-
Remate peldaño recto 3x33 cm	-	20 pcs. / 3,20 Kg	92 boxes / 295 Kg	-
Peldaño ML 33x33x4 cm - 13 mm	3 pcs / ml	4 pcs. / 13,40 Kg	44 boxes / 590 Kg	-
Cartabón ML 33x33x4 cm - 14 mm	-	1 pcs. / 4,00 Kg	92 boxes / 368 Kg	-
Zanquin ingletado recto 59,6x59,6 cm	-	9 pcs. / 19,80 Kg	56 boxes / 1.110 Kg	-
Zanquin ingletado ML 59,6x59,6 cm izda/dcha	-	9 pcs. / 19,80 Kg	56 boxes / 1.110 Kg	-
Rodapié 9x60 cm - 11 mm	1,66 pcs. / ml	18 pcs. / 19,80 Kg	56 boxes / 1.109 Kg	-
Borde skimmer 45x75x3 cm - 30mm	1,33 pcs. / ml	2 pcs. / 30 Kg	29 boxes / 870 Kg	-

MILÁN	PIEZAS · PIECES · DES MORCEAUX · ЧАСТЕЙ	CAJAS · BOXES · BOITES · КОРБОККИ	PALETS · PALLETES · PALLETES · ПАЛЛЕТЫ	MEDIDAS DE FABRICACIÓN · MANUFACTURING MEASURES
Base 75x75 cm - 11 mm	1,78 pcs / m <sup>2</sup>	2 pcs. / 29,25 Kg	40 boxes / 1.228 Kg	-
Base 75x75 cm - 9,5 mm	1,78 pcs / m <sup>2</sup>	2 pcs. / 29,25 Kg	42 boxes / 1.228 Kg	749x749 mm
Base 14,5x120 cm - 10,1 mm	5,75 pcs / m <sup>2</sup>	4 pcs. / 18,48 Kg	64 boxes / 1.195 Kg	-
Base 33x33 cm - 10 mm	9 pcs. / m <sup>2</sup>	9 pcs. / 22,18 Kg	52 boxes / 1.153 Kg	-
Peldaño recto 33x120x3 cm - 12 mm	0,83 pcs / ml	2 pcs. / 25,90 Kg	11 boxes / 285 Kg	-
Remate peldaño recto 3x33 cm	-	20 pcs. / 3,20 Kg	82 boxes / 263 Kg	-
Zanquin recto izda/dcha 42,3x17,5 cm	-	14 pcs. / 10,0 Kg	54 boxes / 540 Kg	-
Rodapié 9x60 cm - 11 mm	1,66 pcs / ml	18 pcs. / 19,80 Kg	56 boxes / 1.109 Kg	-
Borde Skimmer 45x75 cm	1,33 pcs. / ml	2 pcs. / 30,00 Kg	29 boxes / 870 Kg	-

## STONE

ALBAROC	PIEZAS · PIECES · DES MORCEAUX · ЧАСТЕЙ	CAJAS · BOXES · BOITES · КОРБОККИ	PALETS · PALLETES · PALLETES · ПАЛЛЕТЫ	MEDIDAS DE FABRICACIÓN · MANUFACTURING MEASURES
Base 100x100 cm - 11 mm	1 pcs / m <sup>2</sup>	1 pcs. / 25 Kg	48 boxes / 1.200 Kg	-
Base 100x100 cm - 10 mm	1 pcs / m <sup>2</sup>	2 pcs. / 51,13 Kg	24 boxes / 1.227 Kg	-
Base 14,5x120 cm - 10,1 mm	5,75 pcs / m <sup>2</sup>	4 pcs. / 18,48 Kg	64 boxes / 1.195 Kg	-
Base 33x66,5 cm - 10 mm	4,5 pcs. / m <sup>2</sup>	5 pcs. / 25,38 Kg	40 boxes / 1.015 Kg	-
Base 33x33 cm - 10 mm	9 pcs. / m <sup>2</sup>	9 pcs. / 22,18 Kg	52 boxes / 1.153 Kg	-
Peldaño ML 33x33x4 cm - 13 mm	3 pcs. / ml	4 pcs. / 13,40 Kg	44 boxes / 590 Kg	-
Cartabón ML 33x33x4 cm - 14 mm	-	1 pcs. / 4,00 Kg	92 boxes / 368 Kg	-
Zanquin ML izda/dcha 18x40 cm	-	6 pcs. / 15,00 Kg	57 boxes / 855 Kg	-
Peldaño recto 33x120x3 cm - 12 mm	0,83 pcs / ml	2 pcs. / 25,90 Kg	11 boxes / 285 Kg	-
Remate peldaño recto 3x33 cm	-	20 pcs. / 3,2 Kg	82 boxes / 263 Kg	-
Zanquin recto izda/dcha 18x40 cm	-	6 pcs. / 15,00 Kg	57 boxes / 855 Kg	-
Pasamanos 12,5x66,5x4 cm	1,5 pcs. / ml	5 pcs. / 18,80 Kg	26 boxes / 489 Kg	-
Pasamanos 15,5x66,5x4 cm	1,5 pcs. / ml	5 pcs. / 21,45 Kg	20 boxes / 430 Kg	-
Rodapié 9x40 cm - 15 mm	2,5 pcs. / ml	12 pcs. / 15 Kg	66 boxes / 990 Kg	-

LITOS	PIEZAS · PIECES · DES MORCEAUX · ЧАСТЕЙ	CAJAS · BOXES · BOITES · КОРБОККИ	PALETS · PALLETES · PALLETES · ПАЛЛЕТЫ	MEDIDAS DE FABRICACIÓN · MANUFACTURING MEASURES
Base 100x100 cm - 11 mm	1 pcs / m <sup>2</sup>	1 pcs. / 25 Kg	48 boxes / 1.200 Kg	-
Base 100x100 cm - 10 mm	1 pcs / m <sup>2</sup>	2 pcs. / 51,13 Kg	24 boxes / 1.227 Kg	-
Base 60x120 cm - 10,1 mm	1,39 pcs / m <sup>2</sup>	2 pcs. / 33,53 Kg	30 boxes / 1.006 Kg	-
Base 14,5x120 cm - 10,1 mm	5,75 pcs / m <sup>2</sup>	4 pcs. / 18,48 Kg	64 boxes / 1.195 Kg	-
Base 33x66,5 cm - 10 mm	4,5 pcs. / m <sup>2</sup>	5 pcs. / 25,38 Kg	40 boxes / 1.015 Kg	-
Peldaño recto 33x120x3 cm - 12 mm	0,83 pcs / ml	2 pcs. / 25,90 Kg	11 boxes / 285 Kg	-
Remate peldaño recto 3x33 cm	-	20 pcs. / 3,2 Kg	82 boxes / 263 Kg	-
Zanquin recto izda/dcha 18x40 cm	-	6 pcs. / 15,00 Kg	57 boxes / 855 Kg	-
Rodapié 9x40 cm - 15 mm	2,5 pcs. / ml	12 pcs. / 15 Kg	66 boxes / 990 Kg	-
Borde desbordante 28x66,5 cm	1,5 pcs. / ml	2 pcs. / 13,60 Kg	72 boxes / 980 Kg	-
Ángulo borde desbordante 31x31 cm	-	1 pcs. / 4,30 Kg	92 boxes / 396 Kg	-
Rejilla 24,5x24,5 cm	4 pcs. / ml	6 pcs. / 15,78 Kg	57 boxes / 900 Kg	-
Ángulo rejilla izda/dcha 24,5x33 cm	-	1 pcs. / 4,50 Kg	82 boxes / 369 Kg	-
Media caña 33x4 cm - r-3	3 pcs. / ml	52 pcs. / 13 Kg	64 boxes / 832 Kg	33x4,2
Uña 4x4 cm	-	4 pcs. / 0,4 Kg	72 boxes / 30 Kg	4,2x4,2
Arista 33x3 cm - r-3	3 pcs. / ml	70 pcs. / 13 Kg	64 boxes / 832 Kg	33x3,3
Uña arista 3x3 cm	-	4 pcs. / 0,4 Kg	72 boxes / 30 Kg	3,3x3,3



## STONE

MANHATTAN	PIEZAS · PIECES · DES MORCEAUX · ЧАСТЕЙ	CAJAS · BOXES · BOITES · КОРОБКИ	PALETS · PALLETS · PALLETES · ПАЛЛЕТЫ	MEDIDAS DE FABRICACIÓN · MANUFACTURING MEASURES
Base 24,5x24,5 cm - 9 mm	16 pcs. / m <sup>2</sup>	16 pcs. / 19,79 Kg	69 boxes / 1.365 Kg	-
Base 12x24,5 cm - 9 mm	32 pcs. / m <sup>2</sup>	35 pcs. / 19,25 Kg	77 boxes / 1.482 Kg	-
Listelo 5,75x24,5 cm (doble)	64 pcs. / m <sup>2</sup>	72 pcs. / 20,16 Kg	77 boxes / 1.552 Kg	-
Rodapié 9x24,5 cm - 11 mm	4 pcs. / ml	32 pcs. / 12,01 Kg	80 boxes / 960 Kg	-
Vierteaguas 15x24,5x4 cm	4 pcs. / ml	8 pcs. / 7,00 Kg	78 boxes / 546 Kg	-
Peldaño ML 24,5x33x4 cm - 13 mm	4 pcs. / ml	4 pcs. / 9,50 Kg	66 boxes / 627 Kg	-
Cartabón ML 33x33x4 cm - 14 mm	-	1 pcs. / 4,00 Kg	92 boxes / 368 Kg	-
Zanquin ML izda/dcha 39,5x17,5 cm	-	14 pcs. / 10,00 Kg	54 boxes / 540 Kg	-

PETRA	PIEZAS · PIECES · DES MORCEAUX · ЧАСТЕЙ	CAJAS · BOXES · BOITES · КОРОБКИ	PALETS · PALLETS · PALLETES · ПАЛЛЕТЫ	MEDIDAS DE FABRICACIÓN · MANUFACTURING MEASURES
Base 33x33 cm - 10 mm	9 pcs. / m <sup>2</sup>	9 pcs. / 22,18 Kg	52 boxes / 1.153 Kg	-
Rodapié 9x33 cm - 11 mm	3 pcs. / ml	24 pcs. / 13,92 Kg	68 boxes / 947 Kg	-
Peldaño Fiorentino 33x33x3 cm - 12 mm	3 pcs. / ml	4 pcs. / 12,49 Kg	56 boxes / 700 Kg	-
Cartabón Fiorentino 33x33x3 cm - 14 mm	-	1 pcs. / 4,00 Kg	92 boxes / 368 Kg	-
Zanquin Fior. izda/dcha 39,5x17,5 cm (gris)	-	14 pcs. / 10,00 Kg	54 boxes / 540 Kg	-
Zanquin Ingletrado Fior. izda/dcha 32,8x32,8 cm (bone / ocre)	-	12 pcs. / 13,92 Kg	68 boxes / 947 Kg	-
Taco Petra Etna 8x8 cm	-	108 pcs. / 17,28 Kg	82 boxes / 141,7 Kg	-
Tabica Etna Petra 15x33 cm	3 pcs. / ml	12 pcs. / 13,20 Kg	90 boxes / 1.188 Kg	-
Borde piscina 28x33 cm	3 pcs. / ml	4 pcs. / 22,28 Kg	38 boxes / 847 Kg	-
Ángulo Interior 33x33 cm	-	1 pcs. / 4,80 Kg	92 boxes / 441 Kg	-
Ángulo exterior 28x28 cm	-	1 pcs. / 4,00 Kg	92 boxes / 368 Kg	-

VEGA	PIEZAS · PIECES · DES MORCEAUX · ЧАСТЕЙ	CAJAS · BOXES · BOITES · КОРОБКИ	PALETS · PALLETS · PALLETES · ПАЛЛЕТЫ	MEDIDAS DE FABRICACIÓN · MANUFACTURING MEASURES
Base 33x33 cm - 10 mm	9 pcs. / m <sup>2</sup>	9 pcs. / 22,18 Kg	52 boxes / 1.153 Kg	-
Rodapié 9x33 cm - 11 mm	3 pcs. / ml	24 pcs. / 13,92 Kg	68 boxes / 947 Kg	-
Peldaño Fiorentino 33x33x3 cm - 12 mm	3 pcs. / ml	4 pcs. / 12,49 Kg	56 boxes / 700 Kg	-
Cartabón Fiorentino 33x33x3 cm - 14 mm	-	1 pcs. / 4,00 Kg	92 boxes / 368 Kg	-
Zanquin Fior. izda/dcha 39,5x17,5 cm (ocre / visón / gris)	-	14 pcs. / 10 Kg	54 boxes / 540 Kg	-
Zanquin Ingletrado Fior. izda/dcha 32,8x32,8 cm (rojo)	-	12 pcs. / 13,92 Kg	68 boxes / 947 Kg	-
Vierteaguas 12x33x3 cm	3 pcs. / ml	16 pcs. / 18,05 Kg	52 boxes / 938Kg	-

## EARTH

ALHAMAR	PIEZAS · PIECES · DES MORCEAUX · ЧАСТЕЙ	CAJAS · BOXES · BOITES · КОРОБКИ	PALETS · PALLETS · PALLETES · ПАЛЛЕТЫ	MEDIDAS DE FABRICACIÓN · MANUFACTURING MEASURES
Base 33x33 cm - 10 mm	9 pcs. / m <sup>2</sup>	9 pcs. / 22,18 Kg	52 boxes / 1.153Kg	-
Base 16,25x33 cm - 10 mm	18 pcs. / m <sup>2</sup>	18 pcs. / 21,60 Kg	56 boxes / 1.210 Kg	-
Base 16,25x16,25 cm - 10 mm	36 pcs. / m <sup>2</sup>	18 pcs. / 10,80 Kg	112 boxes / 1.210 Kg	-
Rodapié 9x33 cm - 11 mm	3 pcs. / ml	24 pcs. / 13,92 Kg	68 boxes / 947 Kg	-
Peldaño Fiorentino 33x33x3 cm - 12 mm	3 pcs. / ml	4 pcs. / 12,49 Kg	56 boxes / 700 Kg	-
Cartabón Fiorentino 33x33x3 cm - 14 mm	-	1 pcs. / 4,00 Kg	92 boxes / 368 Kg	-
Zanquin Fior. izda/dcha 39,5x17,5 cm (blanco / salmón / rojo)	-	14 pcs. / 10,00 Kg	54 boxes / 540 Kg	-
Zanquin Ingletrado Fior. izda/dcha 32,8x32,8 cm (paja)	-	12 pcs. / 13,92 Kg	68 boxes / 947 Kg	-
Vierteaguas 15x33x4 cm	3 pcs. / ml	8 pcs. / 10,56 Kg	52 boxes / 550 Kg	-
Decorative / Clay 33x33 cm	9 pcs. / m <sup>2</sup>	9 pcs. / 22,18 Kg	52 boxes / 1.153 Kg	-
Tabica Clay 15x33 cm	3 pcs. / ml	12 pcs. / 13,20 Kg	82 boxes / 1.083 Kg	-

## METAL

METÁLICA	PIEZAS · PIECES · DES MORCEAUX · ЧАСТЕЙ	CAJAS · BOXES · BOITES · КОРОБКИ	PALETS · PALLETS · PALLETES · ПАЛЛЕТЫ	MEDIDAS DE FABRICACIÓN · MANUFACTURING MEASURES
Base 33x33 cm - 10 mm	9 pcs. / m <sup>2</sup>	9 pcs. / 22,18 Kg	52 boxes / 1.153 Kg	-
Rodapié 9x33 cm - 11 mm	3 pcs. / ml	24 pcs. / 13,92 Kg	68 boxes / 947 Kg	-
Peldaño Fiorentino 33x33x3 cm - 12 mm	3 pcs. / ml	4 pcs. / 12,49 Kg	56 boxes / 700 Kg	-
Cartabón Fiorentino 33x33x3 cm - 14 mm	-	1 pcs. / 4,00 Kg	92 boxes / 368 Kg	-
Zanquin Fio. izda/dcha 39,5x17,5 cm	-	14 pcs. / 10,00 Kg	54 boxes / 540 Kg	-



EXAGRES se reserva el derecho de anular, modificar total o parcialmente cualquiera de los colores, formatos, referencias y especificaciones técnicas contenidas en este catálogo. Los colores reproducidos en este catálogo son orientativos y pueden variar respecto a la pieza original. Los códigos de precios, medidas y referencias deben verificarse ya que pueden haber errores tipográficos.

EXAGRES reserves the right to partially or totally cancel or modify any of the colours, formats, references and technical specifications contained in this catalogue. The colours reproduced in this catalogue are intended as a guide and may vary in the original piece. The price codes, measures and references must be verified as there may be typographical errors.

EXAGRES se réserve le droit d'annuler, de modifier totalement ou partiellement toutes les couleurs, tous les formats, toutes les références et spécificités techniques contenues dans ce catalogue. Les couleurs reproduites dans ce catalogue sont à titre indicatif et peuvent varier par rapport à la pièce originale. Les codes de prix, les mesures et les références doivent être vérifiés, car il peut y avoir des erreurs typographiques.

Компания EXAGRES оставляет за собой право отменить или изменить, полностью или частично, любой из цветов, форматов, артикулов, а также технические характеристики, содержащиеся в этом каталоге. Все приведенные в данном каталоге цвета являются приблизительными и могут незначительно отличаться от цвета оригинального изделия. Цены, размеры и номера артикулов должны быть предварительно уточнены, поскольку в каталоге могут присутствовать типографические опечатки.